



Cable routing systems

Building Connections

Digitalisation, the Energiewende (energy transition), mobility – the future is gathering speed. At OBO Bettermann, we're proud to be a driving force. And as a facilitator, we make connections. Today, we are already developing the innovative electrical infrastructure systems and solutions of tomorrow. Reliably, flexibly, sustainably.

Already today, OBO is one of the leading manufacturers of installation systems for the electrical infrastructure in buildings and plants. When it comes to the friction-free flow of power, energy and data, engineers and tradespeople worldwide rely on the comprehensive range from OBO.



Gebäudeelektronik - Leistungsfähige Systemlösungen / en / 2023/05/02 10:01:36 10:01:36 (LLEExport_032994) / 2023/05/02 10:01:58 10:01:58

OBO applies its slogan "Building Connections" to around 30,000 high-quality branded electrical products and services, which are used in application solutions for projects in industry, business and infrastructure.

OBO operates a global network and employs more than 4,200 people in more than 60 countries. The headquarters of the family company, which was founded in 1911, is located in Menden, Germany. In addition, more than 40 subsidiaries are present in markets on all continents.



Improved structure, sharpened profile



Each of our products carries a benefit which only the OBO brand can offer. Products are developed, manufactured and tested with a high level of competence – from the idea through to the final check. From flawless logistics through to practical information – we can provide support at every level. We can offer additional security through certificates on the conformity of our products with the most important standards and directives. In a nutshell – OBO helps you more. In every location and in every phase of a project.

To maintain this, we continually challenge ourselves. Not as an end in itself but for the better processing of each customer's requests – fast, reliably and future-oriented. That is the reason we have not only established our three central application areas, but also reworked our catalogue structure. In this way, we can display our service offers more clearly, highlight the product benefits more effectively and illustrate the respective application areas more tangibly.

OBO Product Worlds



Industrial installations

- Cable support systems
- Connection and routing systems
- Fastening material



Building installations

- Cable routing systems
- Device installation ducts, trunking and poles
- Floor installation systems and underfloor applications
- Installation systems



Safety and protection installations

- Surge protection
- External lightning protection
- Equipotential bonding and earthing
- Insulation and cable bandages
- Fire-tested support and routing systems
- Fire protection ducts



It's your choice – from now on there's a catalogue for each OBO product category. Simply select the catalogues and order together with a collection case.

OBO Support & *contact*

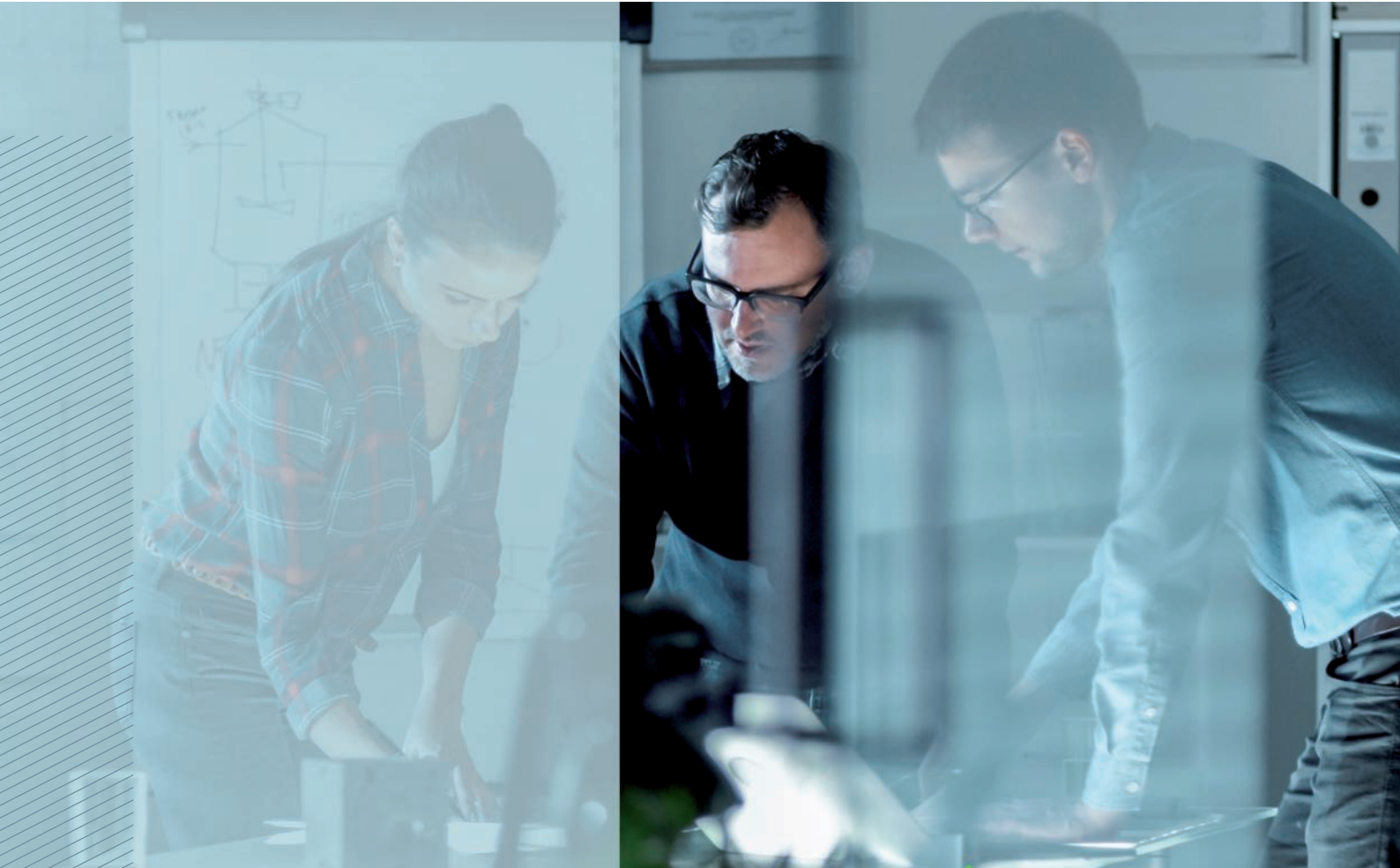

***You have a
problem?
We have the
solution!***

OBO Bettermann is more than the sum of its products. In any situation, we are the reliable partner right by your side. You have a problem? We have the solution!

It doesn't matter in which area of industry our support is needed – from industrial and plant engineering to private, public and administrative buildings, as well as in the areas of mobility and renewable energies – we have everything that you need.

OBO can not only provide the entire electro-technical infrastructure with the best possible products. We can also support you with sound expert knowledge and more than 100 years of experience, right from the planning phase through to the realisation of your projects. OBO – solutions you can rely on.

Customer Service

Tel.: +49 23 73 89 - 17 00

Monday–Thursday
07.30–17.00

Friday
07.30–15.00

export@obo.de

What is OBO Support?

Every OBO product carries a plus inside it, which only a branded product can offer. It is developed, manufactured and tested with a high level of competence, from the idea right through to the final check. In addition, our specialists are available for consultation and can offer you assistance and training courses for products at any time.

Together with you, we plan your project and help you choose the right products, and are also available to you at any time should you need us. From flawless logistics through to practical information – we can provide support at every level. We can offer security through certificates on the conformity of our products with the most important standards and directives.

We are as flexible as you are – because we know how practical people work and what is important to them. Each step is a plus – that is the OBO Support concept.



Service



Training



Handling



Certification

Service – OBO can help

Everywhere and in every project phase:

- Highly competent hotline
- Product and system information, digitally or printed
- Selection and planning aids on the web, as an app, as a CAD application or in printed form
- 2D and 3D product data for planning
- Field service, branch offices and subsidiaries in 60 countries
- Engineering services for major projects

Training courses from OBO

- Seminars and workshops
- Local consultation and training courses
- Planner days

Handling – OBO delivers reliably

With optimised delivery processes:

- Reliable logistics
- Practical transport systems and packaging
- Loading gear handling and disposal concepts

Certification and guarantee

OBO offers safety. Our products fulfil the most important country-specific regulations:

- Conformity (e.g. IEC, VDE, CE, KEMA, KEUR, UL)
- Certification (e.g. DIN EN, DGNB)
- 5-year guarantee for surge protection products
- Guarantee management



Planning aids

Page 10



Plastic cable routing trunking

Page 30



Plastic cable routing trunking, halogen-free

Page 120



Metal cable routing trunking

Page 142



Skirting trunking

Page 170



Wiring trunking

Page 202



Directories

Page 256





Gebäudesteuerung - Leitungssysteme / en / 2023/05/02_10:01:36 (LLExploit_03294) / 2023/05/02_10:01:36 (LLExploit_03294)

Planning aids

| | |
|---|----|
| Inclusion of the cable routing systems and metal service poles in the service measures | 12 |
| Who needs to observe which standards? | 14 |
| How can I work out the cable volume? | 15 |
| Basic values for the calculation of the cable volume | 16 |
| Processing materials with the correct tool | 17 |
| Halogen-free cable routing systems | 18 |
| Individual special colours | 20 |
| Powder coatings for indoor use | 21 |
| Plastic materials | 22 |
| European classification according to EN 50085-1 | 25 |
| Chemical resistances of hard PVC | 28 |

Inclusion of the cable routing systems and metal service poles in the service measures



Specifications for safety measures

If there is a fault, touchable metallic parts must not carry voltage. For this reason, it is necessary to carry out appropriate safety measures. These are specified in the currently valid standards. For the creation of cable routing systems the standards DIN EN 50085-1 and DIN EN 50085-2-1 apply, for the installation itself the erector regulations DIN VDE 0100 Part 410 and 540 (safety measure against dangerous shock currents) are applicable.

Different installation types in the European standard

The European standard DIN EN 50085-1 takes different installation types into account, as they are used in different countries within the EU. While only equipotential bonding testing was previously required for installation trunking systems, now the listed component standards also require protective conductor functions. This is because, in some countries, it is possible to route insulated cable in trunking.

All metallic components must be included

DIN EN 50085-1 requires that all the metallic components can be included in the protective measures. The manufacturers must carry out the appropriate tests and document them. OBO installation trunking is also tested and certified by an external testing office – that of the VDE.

Testing the effectiveness by the installation engineers

The erection engineer (installation engineer) must test the effectiveness of the protection measures in accordance with DIN VDE 0100 Part 610 after completion. The tightening torque of the contact screws on the earthing terminals and the proper mounting of the couplings must be ensured.



Continuous protection measures

If the trunking is interrupted at a wall penetration, then continuation of the protective measures is required, as the trunking forms a foreign, conductive part in this case, which spreads through different areas of a building.

With the LKM metallic cable routing trunking, the connection between the cover and base is made without an additional earthing cable. Joint connectors guarantee equipotential bonding between the bases.

Important: Powder-coated metallic covers do not count as mixed construction and are thus not considered as insulating! They should therefore be included in the protection measures. The sheet steel partition is self-contacting. The shielding measure reduces electro-smog and generally achieves improved EMC protection. Protective conductor connections should be created permanently. If there is a change to the system, e.g. for retro-installations, it is important to guarantee the maintenance of the protective functions.

Who needs to observe which standards?

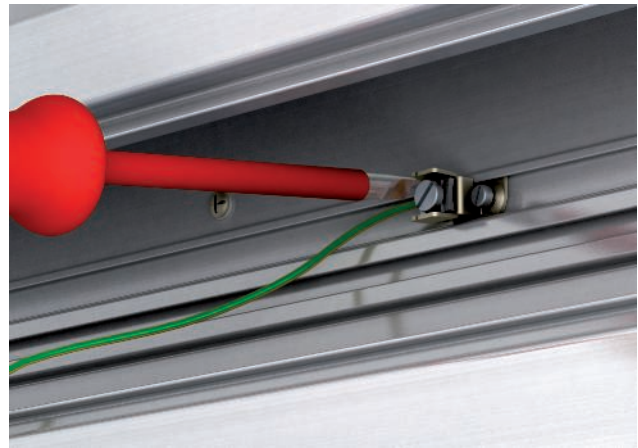

OBO as a manufacturer

| Standard | Title | OBO system |
|--|---|------------------------------------|
| DIN EN 50085-1 Device testing directive | Installation trunking systems for electrical installations – Part 1: General requirements. | All systems |
| DIN EN 50085-2-1 | Special requirements for electrical installation trunking systems on walls or ceilings. | WDK, LKM, SKL, GEK-K, GEK-S, GEK-A |
| DIN EN 50085-2-2 | Special requirements for electrical installation systems for underfloor, flushfloor or on-floor mounting. | Underfloor systems |
| DIN EN 50085-2-3 | Special requirements for wiring trunking systems for installation in switchgear cabinets. | Wiring trunking systems |
| DIN EN 50085-2-4 | Special requirements for free-standing installation units. | Service pole systems |

The installation engineer as systems engineer

| Standard | Title | OBO system |
|-------------------|---|-------------|
| VDE 0100 Part 410 | Set-up of electrical systems with rated voltages of up to 1,000 V. Protection against electric shock. | All systems |
| VDE 0100 Part 520 | Set-up of electrical systems with rated voltages of up to 1,000 V. Cables. | All systems |
| VDE 0100 Part 540 | Set-up of electrical systems with rated voltages of up to 1,000 V. Equipotential bonding. | All systems |
| VDE 0100 Part 610 | Set-up of electrical systems with rated voltages of up to 1,000 V. First testing of electrical systems before handover to the operator. | All systems |
| VDE 0298 | Set-up of electrical systems with rated voltages of up to 1,000 V. Insulated cables in heavy current systems. | All systems |
| DIN EN 50310 | Application of equipotential bonding and earthing in buildings with information technology equipment. | All systems |

How can I work out the cable volume?

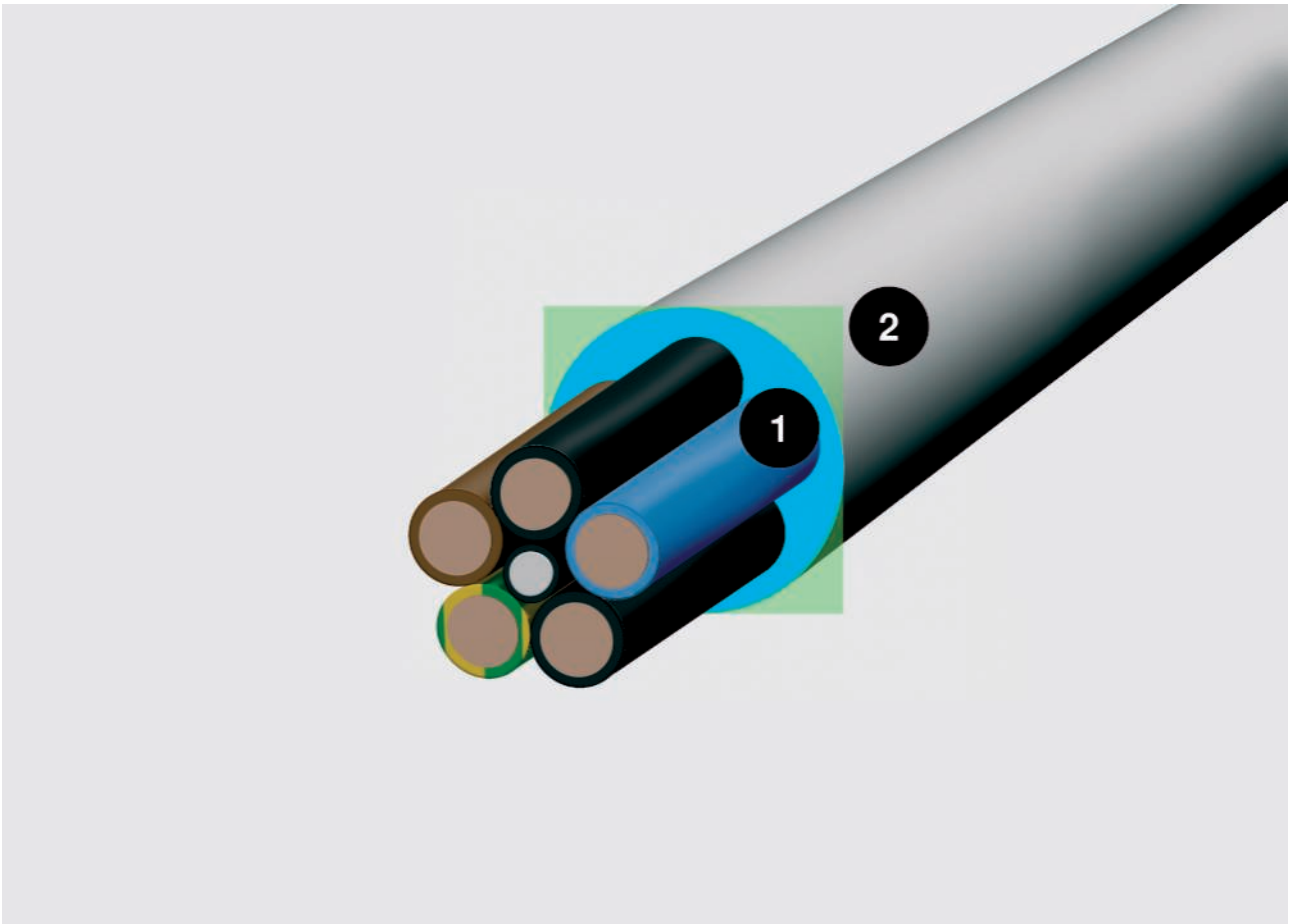

Cable diameter and space required; 1 = diameter in mm, 2 = space required in cm²

An important criterion for the selection of the right trunking size of the underfloor system is the cable volume. As the cables are never packed tightly together or are absolutely parallel, it is not enough to base the volume calculation solely on the cable diameter. A realistic calculation is provided by the formula $(2r)^2$. To simplify your work, we have listed the diameters and space requirements of the most important cable types on this double page. Important: the values are average values, which may vary between manufacturers. Please refer to the manufacturer's specifications for the exact values.

The right choice

The table on the next pages will help you to select the correct trunking size. Besides the usable cross-section of the appropriate trunking, please observe the current DIN/VDE standards for the fill factor and the approved cable heating.

Calculation with the formula $(2r)^2$

The diameter says little about the actual space required by a cable. Calculate: $(2r)^2$. This value reflects the realistic space requirements, including the compartments.

Basic values for the calculation of the cable volume

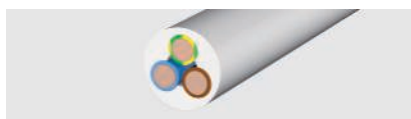

Insulated power cables

| Type | Diameter mm | Usable cross-section cm ² |
|---------|-------------|--------------------------------------|
| 1 x 4 | 6.5 | 0.42 |
| 1 x 6 | 7 | 0.49 |
| 1 x 10 | 8 | 0.64 |
| 1 x 16 | 9.5 | 0.9 |
| 1 x 25 | 12.5 | 1.56 |
| 3 x 1.5 | 8.5 | 0.72 |
| 3 x 2.5 | 9.5 | 0.9 |
| 3 x 4 | 11 | 1.21 |
| 4 x 1.5 | 9 | 0.81 |
| 4 x 2.5 | 10.5 | 1.1 |
| 4 x 4 | 12.5 | 1.56 |
| 4 x 6 | 13.5 | 1.82 |
| 4 x 10 | 16.5 | 2.72 |
| 4 x 16 | 19 | 3.61 |
| 4 x 25 | 23.5 | 5.52 |
| 4 x 35 | 26 | 6.76 |
| 5 x 1.5 | 9.5 | 0.9 |
| 5 x 2.5 | 11 | 1.21 |
| 5 x 4 | 13.5 | 1.82 |
| 5 x 6 | 14.5 | 2.1 |
| 5 x 10 | 18 | 3.24 |
| 5 x 16 | 21.5 | 4.62 |
| 5 x 25 | 26 | 6.76 |
| 7 x 1.5 | 10.5 | 1.1 |
| 7 x 2.5 | 13 | 1.69 |

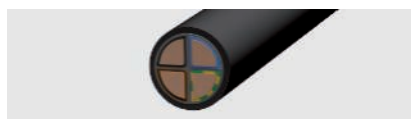

Insulated power cables

| Type | Diameter mm | Usable cross-section cm ² |
|---------|-------------|--------------------------------------|
| 1 x 10 | 10.5 | 1.1 |
| 1 x 16 | 11.5 | 1.32 |
| 1 x 25 | 12.5 | 1.56 |
| 1 x 35 | 13.5 | 1.82 |
| 1 x 50 | 15.5 | 2.4 |
| 1 x 70 | 16.5 | 2.72 |
| 1 x 95 | 18.5 | 3.42 |
| 1 x 120 | 20.5 | 4.2 |
| 1 x 150 | 22.5 | 5.06 |
| 1 x 185 | 25 | 6.25 |
| 1 x 240 | 28 | 7.84 |
| 1 x 300 | 30 | 9 |
| 3 x 1.5 | 11.5 | 1.32 |
| 3 x 2.5 | 12.5 | 1.56 |
| 3 x 10 | 17.5 | 3.06 |
| 3 x 16 | 19.5 | 3.8 |
| 3 x 50 | 26 | 6.76 |
| 3 x 70 | 30 | 9 |
| 3 x 120 | 36 | 12.96 |
| 4 x 1.5 | 12.5 | 1.56 |
| 4 x 2.5 | 13.5 | 1.82 |
| 4 x 6 | 16.5 | 2.72 |
| 4 x 10 | 18.5 | 3.42 |
| 4 x 16 | 21.5 | 4.62 |
| 4 x 25 | 25.5 | 6.5 |
| 4 x 35 | 28 | 7.84 |
| 4 x 50 | 30 | 9 |
| 4 x 70 | 34 | 11.56 |
| 4 x 95 | 39 | 15.21 |
| 4 x 120 | 42 | 17.64 |
| 4 x 150 | 47 | 22 |
| 4 x 185 | 52 | 27 |
| 4 x 240 | 58 | 33.6 |
| 5 x 1.5 | 13.5 | 1.82 |
| 5 x 2.5 | 14.5 | 2.1 |
| 5 x 6 | 18.5 | 3.42 |
| 5 x 10 | 20.5 | 4.2 |
| 5 x 16 | 22.5 | 5.06 |
| 5 x 25 | 27.5 | 7.56 |
| 5 x 35 | 34 | 11.56 |
| 5 x 50 | 40 | 16 |



Telecommunications cables

| Type | Diameter mm | Usable cross-section cm ² |
|---------------|-------------|--------------------------------------|
| 2 x 2 x 0.6 | 5 | 0.25 |
| 4 x 2 x 0.6 | 5.5 | 0.3 |
| 6 x 2 x 0.6 | 6.5 | 0.42 |
| 10 x 2 x 0.6 | 7.5 | 0.56 |
| 20 x 2 x 0.6 | 9 | 0.81 |
| 40 x 2 x 0.6 | 11 | 1.12 |
| 60 x 2 x 0.6 | 13 | 1.69 |
| 100 x 2 x 0.6 | 17 | 2.89 |
| 200 x 2 x 0.6 | 23 | 5.29 |
| 2 x 2 x 0.8 | 6 | 0.36 |
| 4 x 2 x 0.8 | 7 | 0.49 |
| 6 x 2 x 0.8 | 8.5 | 0.72 |
| 10 x 2 x 0.8 | 9.5 | 0.9 |
| 20 x 2 x 0.8 | 13 | 1.69 |
| 40 x 2 x 0.8 | 16.5 | 2.72 |
| 60 x 2 x 0.8 | 20 | 4 |
| 100 x 2 x 0.8 | 25.5 | 6.5 |
| 200 x 2 x 0.8 | 32 | 10.24 |



Coax cable (Standard)

| Type | Diameter mm | Usable cross-section cm ² |
|--------------|-------------|--------------------------------------|
| SAT/BK cable | 6.8 | 0.48 |



IT cables type Cat...

| Type | Diameter mm | Usable cross-section cm ² |
|--------|-------------|--------------------------------------|
| Cat. 5 | 8 | 0.64 |
| Cat. 6 | 8 | 0.64 |



Processing materials with the correct tool

Different materials must be processed differently. Chop saws have proved to be very useful when laying device installation trunking. This allows exact cutting.

For trunking made of PVC and PC/ABS:

- Hand saw, fine-tooth (iron saw)
- Piercing saw with iron or plastic saw blade with fine teeth
- Circular saw with plastic saw blade, 350 mm diameter, 80–108 teeth/inch and 2,800 rpm

For ducts and trunking made of sheet steel and aluminium:

- Ribbon saw with saw ribbon for hard metals
- Circular saw with saw blade for hard metals, 350 mm diameter, 80–108 teeth/inch and 2,800 rpm
- Angle grinder with metal separating disc

Thermal expansion coefficient:

- Steel: 14×10^{-6} 1/K
- Aluminium: 23.1×10^{-6} 1/K
- Hard PVC: 71×10^{-6} 1/K

Take the length expansion of the materials into account

Different materials expand differently and this must be taken into account. The expansion of the materials PVC, steel and aluminium can be calculated using the formula below.

$$\Delta L = L \cdot \alpha \cdot \Delta T$$

L = Length m

α = Thermal expansion co-efficient

ΔT = Temperature change

Examples

At a temperature difference ΔT of 20 °C, the 2,000 mm standard length changes as follows:

- For hard PVC, 2.84 mm
- For steel, 0.56 mm
- For aluminium, 0.924 mm

Perfect interplay for more efficient working

Faster and better installation sequences – this is the aim of both ourselves and the manufacturers of electrical devices. Previously used bolt-firing devices have thus become modern nail guns. With its Pulsa 700E, Spit can offer devices of the highest quality for this area of the electrical industry. Many OBO products can be processed particularly efficiently using the devices. This is proved by tests for mounting cable and device installation trunking, carried out with Spit devices.

Properties of the hard PVC used

| Property | Value | DIN |
|---|---------------------------|-----------------|
| Material designation | PVC-U-E-D-08-04-28 | to DIN 7748 |
| Tensile strength | min. 40 N/mm ² | to DIN 53 455 |
| Crack expansion | min. 85% | to DIN 53 455 |
| Breakdown voltage | min. 20 KV/mm | to DIN 53 481 |
| Surface resistance | min. 1010 Ohm | to DIN 53 455 |
| Shape heat resistance | min. 75 °C | to DIN 53 400/B |
| Temperature resistance in the application | max. 65 °C | |
| Flammability | Level V0 | to UL 94 |

You can find more details in the chapter "Chemical resistance of hard PVC" in the "Additional information" part.

Halogen-free cable routing systems

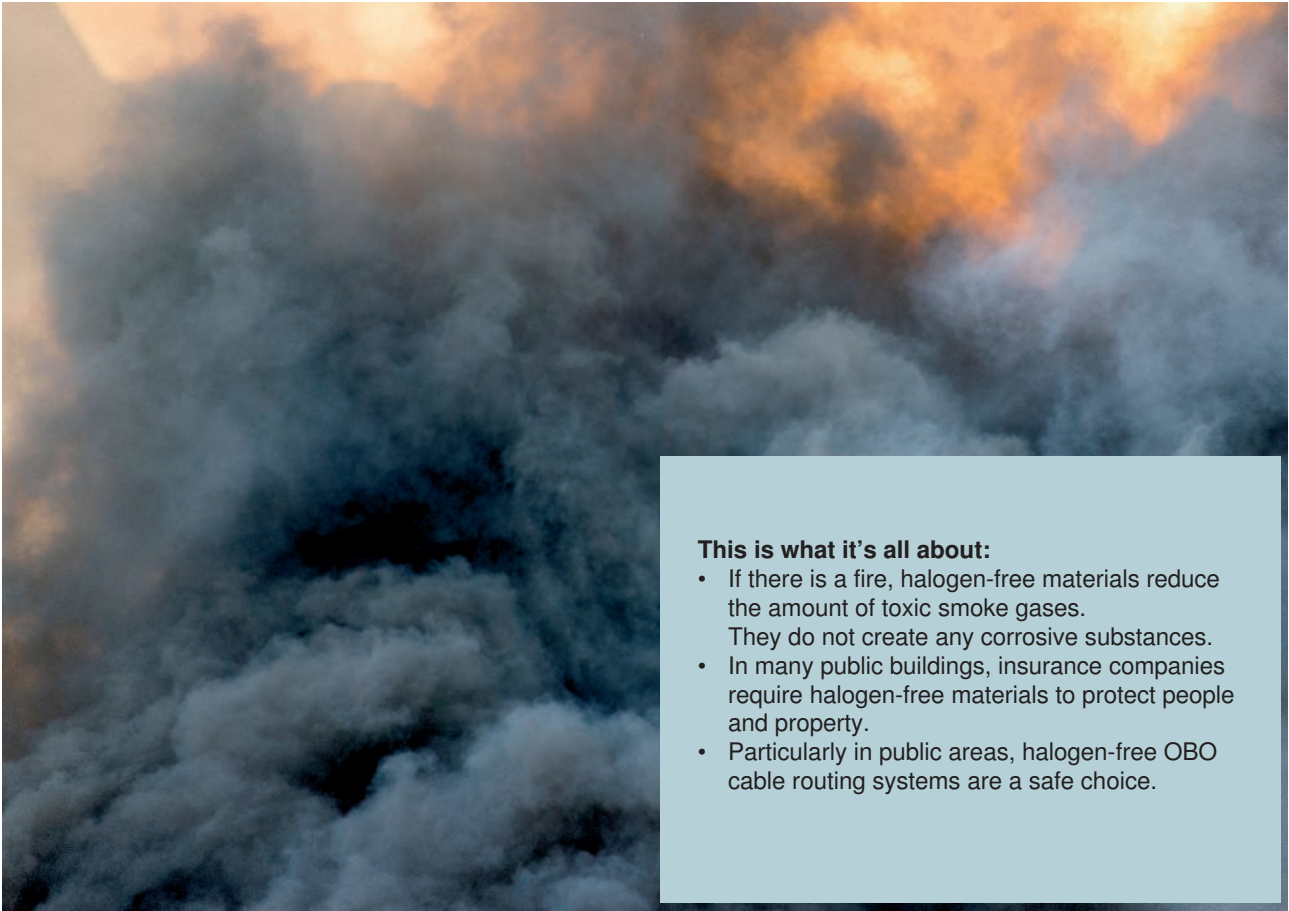

This is what it's all about:

- If there is a fire, halogen-free materials reduce the amount of toxic smoke gases. They do not create any corrosive substances.
- In many public buildings, insurance companies require halogen-free materials to protect people and property.
- Particularly in public areas, halogen-free OBO cable routing systems are a safe choice.

Low smoke gas production, low corrosion, safe. Halogen-free installation materials belong in any fire protection plan.

Dangerous smoke gases from plastics

Plastics have good insulating properties and can be processed easily. However, during a fire they can create aggressive gases. A danger to people and property.

Heavy smoke creation

Flame-protection agents, based on halogen compounds such as fluorine, iodine, chlorine and bromine, are used to keep the flammability of PVC low. If there is a fire, this safety aspect becomes a dangerous disadvantage: toxic smoke gases, such as carbon dioxide and carbon monoxide, are created. These usually endanger people far faster than flames and heat. For example, in the fire catastrophe at Düsseldorf Airport in 1996 or in the Tauern Tunnel in 1999, considerable quantities of burned plastics contributed to the formation of smoke and hazardous substances. A highly toxic mixture, which can be lethal after just a few breaths.

Protecting existing buildings better

To ensure increased protection of properties in the event of fire and to prevent subsequent fire damage and costs, halogen-free cable routing systems (made of PC/ABS) must be installed in many public buildings. Standard PVC releases corrosive hydrogen chloride gas, which, in conjunction with the moisture of the extinguishing water, produces hydrochloric acid. Hydrochloric acid presents a wealth of risks: On the one hand, it is harmful to health, as it irritates the respiratory passages and, on the other hand, it attacks buildings because it eats its way through metals and, as an electrically conductive substance, can lead to short circuits. This is why all the halogen-free cable routing systems meet the requirements of DIN EN 50085.



**HALOGEN
FREE**



OBO halogen-free cable routing systems protect people, the environment and property. All the products are made from high-quality PC/ABS (polycarbonate/acrylonitrile butadiene styrene). This material is one of the self-extinguishing plastics.

For safe cable routing, OBO offers halogen-free WDKH wall and ceiling trunking and Rapid 80 device installation trunking. Both cable routing systems are available in all the standard dimensions. They are easy to mount, and are stable, are produced to a high level of quality and are dimensionally stable.

The safety aspects

- Low smoke creation
- Low toxicity of the smoke gases
- Scarcely any release of corrosive gases
- Perfectly suitable for public areas

Rapid 80 GKH halogen-free

Rapid 80 device installation trunking allows flexible and quick access to energy and data on the wall. It is primarily used in public facilities and offices.

WDKH halogen-free

OBO wall and ceiling trunking ensures safe cable routing. It can be used as wall or ceiling trunking.

Individual special colours



Plastic trunking

The wide range of standard colours and the many possible special colours mean that it is possible to integrate the colour of the cable routing systems into any office landscape. The plastic cable routing trunking and device installation trunking systems are available in the RAL colours pure white (RAL 9010), light grey (RAL 7035), grey (RAL 7030) and cream (RAL 9001) as standard.

Sheet steel and aluminium trunking

The device installation trunking systems and service poles are made of sheet steel or aluminium and are available in the standard colours pure white, light grey and cream. Powder coating means that all the other RAL colours are possible on sheet steel and aluminium trunking. Alternatively to the RAL standard, both NCS and DB colours can be applied on request.

Colour deviations

Material-dependent colour deviations may occur on PVC trunking and fittings. This is caused by the differences in gloss on each individual surface. They only absorb a part of the light. "Silky matt" painted surfaces and "matted" surfaces on moulded parts have different structures and thus different levels of gloss. Absolute evenness is impossible. With a shiny surface, a colour appears lighter (greater reflection) and, with a matt surface, darker (greater absorption). Measurement of the differences is therefore extremely difficult.

Powder coatings for indoor use

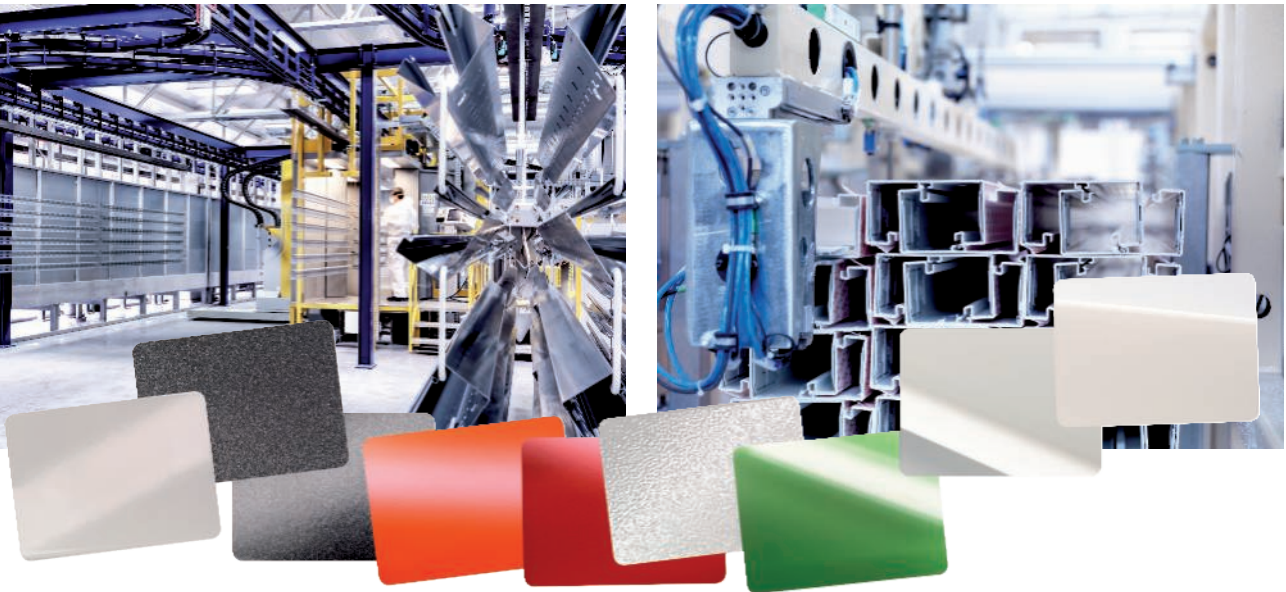

Versatile. Attractive. Robust.

Powdered surface coatings offer a wide range of options. They turn a standard product into an individual solution, whose colour and function are matched exactly to your requirements. The colour and structure ensure a decorative exterior, whilst the coating properties offer high resistance to chemicals, very good corrosion protection and the best possible insulation properties.

| | |
|----------------------------|--|
| Basic | Sheet steel or aluminium |
| Coating | Epoxy powder-coating |
| Standard colours | RAL 9010, pure white RAL 9001, cream white RAL 7035, light grey RAL 9016, traffic white |
| Special colours | RAL, NCS and DB colours Metallic colours |
| Surface structure | Standard structure: Smooth transitions, different variants from fine to coarse |
| Surface shine level | Standard gloss level: Approx. 22% diverse variants from matt to high-gloss |
| Variants | Anti-bacterial High resistance to abrasion |

Plastic materials

| ABS/ ASA | Acrylonitrile butadiene styrene |
|------------------------------------|---|
| Temperature resistance: | To about minus 40 °C*, permanently up to 70 °C, briefly up to 85 °C |
| Resistant to: | Formic acid, citric acid, lactic acid |
| Unstable with: | Acetone, petrol, benzene, solvents for paints and butyric acid, chlorine, acetic acid, nitric acid. |
| Conditionally resistant to: | Hydrochloric acid, sulphuric acid. |
| Risk of stress cracks: | Relatively high, similar to polystyrene. |

| PA | Polyamide |
|--------------------------------|---|
| Temperature resistance: | Permanently up to approx. 90 °C, briefly up to around 130 °C, and to around minus 40 °C* |
| Resistant to: | Petrol, benzene, diesel oil, acetone, solvents for paints and lacquers, oils and greases |
| Unstable with: | Bleach, most acids, chlorine. |
| Risk of stress cracks: | Low in humid conditions; only with some aqueous salt solutions. Highly desiccated parts (high temperature and extremely low air humidity) are highly sensitive to fuels and various solvents. |

| PA/ GF | Polyamide, fibreglass reinforced |
|--------------------------------|---|
| Temperature resistance: | Permanently up to approx. 100–110 °C, briefly up to around 160 °C, and to around minus 40 °C* |
| Resistant to: | Petrol, benzene, diesel oil, acetone, solvents for paints and lacquers, oils and greases. Slightly susceptible to stress cracking. |
| Unstable with: | Bleach, most acids, chlorine. |
| Risk of stress cracks: | Low in humid conditions; only with some aqueous salt solutions. Highly desiccated parts (high temperature and extremely low air humidity) are highly sensitive to fuels and various solvents. |

| PBPT | Polybutylene terephthalate |
|------------------------------------|--|
| Temperature resistance: | Permanently up to approx. 120 °C, briefly up to around 140 °C and to around minus 40 °C*. |
| Resistant to: | Petrol, diesel oil, most weak acids, oils and greases. |
| Unstable with: | Strong acids, chlorine, fluorine, bromine vapour, bleach, trichloroethylene, methylene chloride. |
| Conditionally resistant to: | Acetone, ammonia, benzene. |

| PE | Polyethylene |
|------------------------------------|---|
| Temperature resistance: | Hard types permanently up to approx. 90 °C, briefly up to approx. 105 °C, soft types permanently up to approx. 80 °C, briefly up to approx. 100 °C and to approx. minus 40 °C*. |
| Resistant to: | Alkalis and inorganic acids. |
| Unstable with: | Chlorine, hydrocarbons, oxidising acids. |
| Conditionally resistant to: | Acetone, organic acids, petrol, benzene, diesel oil, most oils. |
| Risk of stress cracks: | Stress cracks can be caused by, among other things, acetone, various alcohols, formic acid, ethanol, petrol, benzene, butyric acid, acetic acid, formaldehyde, various oils, petroleum, propanol, nitric acid, hydrochloric acid, sulphuric acid, soap solutions, turpentine, trichloroethylene, citric acid. |



| | |
|--------------------------------|--|
| PP/GF | Polypropylene, fibreglass reinforced |
| Temperature resistance: | Permanently up to approx. 90 °C, briefly up to around 110 °C, and to around minus 30 °C. Chem. resistance generally as for polyethylene |
| Resistant to: | Alkalis and inorganic structures |
| Unstable with: | Chlorine, hydrocarbons, oxidising acids. |
| Risk of stress cracks: | Low, only with some acids such as chromic acid, hydrofluoric acid and hydrochloric acid, as well as nitrogen oxide. |

| | |
|--------------------------------|---|
| PC | Polycarbonate |
| Temperature resistance: | Permanently up to approx. 110 °C (in water 60 °C), briefly up to 125 °C, and to below minus 35 °C* |
| Resistant to: | Petrol, turpentine, most weak acids. |
| Unstable with: | Acetone, benzene, chlorine, methylene chloride, most concentrated acids. |
| Risk of stress cracks: | Relatively low, media which can cause tension cracking include petrol, aromatic hydrocarbons, methanol, butanol, acetone, turpentine. |

| | |
|------------------------------------|---|
| PC/ABS | Polycarbonate/acrylonitrile butadiene styrene |
| Temperature resistance: | -30 °C to + 90 °C, briefly up to approx. 105 °C, melting range at approx. 200 °C, thermal decomposition at 300 °C. Material thicknesses of 1.5 mm or more can achieve UL94 V-0. At material thicknesses of 1 mm or more, the glow wire temperature of 960 °C according to IEC 60695-2-12 is achieved. |
| Resistant to: | Mineral acids, organic acids and aqueous salt solutions |
| Conditionally resistant to: | Alkalis, hydrocarbons, aromatics and (in trace form) a series of greases and oils. |

| | |
|--------------------------------|--|
| POM | Polyacetal |
| Temperature resistance: | Permanently up to approx. 100 °C, briefly up to around 130 °C and to around minus 40 °C* |
| Resistant to: | Acetone, ether, petrol, weak acetic acid, benzene, heating oil, oils and greases, toluene. |
| Unstable with: | Methylene chloride, trichloroethylene, hydrochloric acid, nitric acid, sulphuric acid. |
| Risk of stress cracks: | Low |

| | |
|------------------------------------|---|
| PP | Polypropylene |
| Temperature resistance: | Permanently up to approx. 90 °C, briefly up to around 110 °C, and to around minus 30 °C. Chemical resistance generally as for polyethylene. |
| Resistant to: | Alkalis and inorganic acids. |
| Unstable with: | Chlorine, hydrocarbons, oxidising acids. |
| Conditionally resistant to: | Acetone, organic acids, petrol, benzene, diesel oil, most oils. |
| Risk of stress cracks: | Low, only with some acids such as chromic acid, hydrofluoric acid and hydrochloric acid, as well as nitrogen oxide. |

| | |
|------------------------------------|---|
| PS | Polystyrene |
| Temperature resistance: | Because of its relatively high sensitivity to the effects of chemicals, its use is not recommended at temperatures above normal room temperature, about 25 °C. Resistance to cold: to about minus 40 °C*. |
| Resistant to: | Alkalis, most acids, alcohol. |
| Unstable with: | Butyric acid, concentrated nitric acid, concentrated acetic acid, acetone, ether, petrol and benzene, solvents for paints and lacquers, chlorine, diesel fuel. |
| Conditionally resistant to: | Oils and greases. |
| Risk of stress cracks: | Relatively high. Stress cracks can be caused by, among other things, acetone, ether, petrol, cyclohexane, heptane, methanol, propanol and the softeners of some mixes used in PVC cables. |



| PVC | Polyvinyl chloride |
|--|--|
| Temperature resistance: | Permanently up to approx. 65 °C, briefly up to around 75 °C and to around minus 30 °C. |
| Resistant to: | Weak acids, alkalis, oils and greases, petrol |
| Unstable with: | Strong acids, benzene, acetone, iodine, toluene, trichloroethylene. |
| Risk of stress cracks: | Low, only with some solvents such as benzene and acetone. |
| Material designation according to DIN 7748: | PVC-U-E-D-080-04-28 |
| Tensile strength to DIN 53 455: | Min. 40 N/mm ² |
| Elongation at tear according to DIN 53 455: | Min. 65% |
| Impact resistance according to DIN 53 481: | Min. 20 KV/mm |
| Surface resistance according to DIN 5 3 482: | Min. 10 10 |
| Thermoforming resistance according to DIN 53 460/B: | Min. 75 °C |
| Flammability according to UL 94: | Level V0 |
| Fire behaviour according to EN 13501-1 | B-s3, d0 |

The minus values apply only for parts in the idle condition with no severe impact stress. There is no plastic that is resistant to every chemical. The agents listed are only a small selection. Plastic parts are especially at risk in the presence of chemicals and high temperatures. Stress cracks may occur. If in doubt, please consult us and/or ask for a detailed chemical resistance table. Stress crack formation: Stress cracks may occur if plastic parts under

tension are exposed to chemicals at the same time. Parts made of polystyrene and polyethylene are particularly susceptible. Stress cracks may even be caused by agents to which the plastic in question is resistant in the absence of stress. Typical examples of parts under constant stress when used as intended: grip clips, intermediate connectors of cable glands, ribbon clips.

European classification according to EN 50085-1



Classification to EN 50085-1

| | | WDK cable duct | WDKH cable duct | LKM cable routing trunking | SKL skirting duct | VK wiring duct | VKH wiring duct | Rapid 45-2 GK PVC device installation duct | Rapid 45-2 GA aluminium device installation duct | Rapid 80 GK PVC device installation duct | Rapid 80 GKH PC/ABS device installation duct | Rapid 80 GS steel device installation duct | Rapid 80 GA aluminium device installation duct | ISS industrial service pole |
|-------|---|----------------|-----------------|----------------------------|-------------------|----------------|-----------------|--|--|--|--|--|--|-----------------------------|
| 6.1 | According to material | *2 | *2 | *2 | *2 | *2 | *2 | *2 | *2 | *2 | *2 | *2 | *2 | *2 |
| 6.2 | According to impact resistance for installation and application | | | *1 | | | | | | | | | | |
| 6.2.1 | Electrical installation duct systems for impact energy 0.5 J | x | | *1 | | | | x | | | | | | |
| 6.2.2 | Electrical installation duct systems for impact energy 1 J | | | *1 | | | | | | | | | | |
| 6.2.3 | Electrical installation trunking systems for impact energy 2 J | | X | *1 | x | | | | | | | | | |
| 6.2.4 | Electrical installation trunking systems for impact energy 5 J | | | *1 | | | | *1 | x | x | | | | |
| 6.2.5 | Electrical installation trunking systems for impact energy 20 J | | | *1 | | | | x | | | | x | x | x |
| 6.3 | According to temperature, as specified in the Tables 1, 2 and 3 | | | | | | | | | | | | | |
| | Table 1: Minimum storage and transport temperatures ± 2 °C | | | | | | | | | | | | | |
| | -45 | | | | | | | | | | | | | |
| | -25 °C | | x | x | | | x | x | x | | | x | x | x |
| | -15 °C | | | | x | | | | | x | x | | | |
| | -5 | x | | | | x | | | | | | | | |
| | Table 2: Minimum installation and application temperatures ± 2 °C | | | | | | | | | | | | | |
| | -25 °C | | | x | | | | | | | | x | x | x |
| | -15 °C | | | | | | | x | x | x | x | | | |
| | -5 | x | x | | x | | | | | | | | | |
| | +5 | | | | | | | | | | | | | |
| | +15 | | | | | | | | | | | | | |
| | Table 3: Maximum application temperatures ± 2 °C | | | | | | | | | | | | | |
| | +60 | x | | | x | x | | x | x | x | | x | x | x |
| | +90 | | x | | | | x | | | x | | | | |
| | +105 | | | | | | | | | | | | | |
| | +120 | | | | | | | | | | | | | |
| 6.4 | According to the resistance against fire spread | | | | | | | | | | | | | |
| 6.4.1 | Electrical installation duct systems which permit the spread of fire | | | | | | | | | | | | | |
| 6.4.2 | Electrical installation trunking systems which do not permit the spread of fire | x | x | x | | x | x | x | x | x | x | x | x | x |

x appropriate classification, *1 in test, *2 in consultation * 5 Joules for accessories made from PC/ABS

Classification to EN 50085-1

| | | WDK cable duct | WDKH cable duct | LKM cable routing trunking | SKL skirting duct | VK wiring duct | VKH wiring duct | Rapid 45-2 GK PVC device installation duct | Rapid 45-2 GA aluminium device installation duct | Rapid 80 GK PVC device installation duct | Rapid 80 GKH PC/ABS device installation duct | Rapid 80 GS steel device installation duct | Rapid 80 GA aluminium device installation duct | ISS industrial service pole |
|--------|---|----------------|-----------------|----------------------------|-------------------|----------------|-----------------|--|--|--|--|--|--|-----------------------------|
| 6.5 | According to the electrical conductivity | | | | | | | | | | | | | |
| 6.5.1 | Electrical installation duct system with electrical conductivity | | | x | | | | | x | | | x | x | x |
| 6.5.2 | Electrical installation duct system without electrical conductivity | x | x | | x | x | x | x | | x | x | | | |
| 6.6 | According to the electrical insulation property | | | | | | | | | | | | | |
| 6.6.1 | Electrical installation duct system without electrical insulation property | | | x | | | | | x | | | x | x | x |
| 6.6.2 | Electrical installation duct system with electrical insulation property | x | x | | x | x | x | x | | x | x | | | |
| 6.7 | According to the protection ratings offered by the housing or casing to EN 60529:1991 | | | | | | | | | | | | | |
| 6.7.1 | According to protection against ingress of solid foreign bodies | IP 30 | IP 30 | IP 30 | IP 41 | | | IP* 40 | IP* 40 | IP 30 | IP 30 | IP 30 | IP 30 | IP 30 |
| 6.7.2 | According to protection against ingress of water | | | | | | | | | | | | | |
| 6.7.3 | According to protection against contact with dangerous parts | | | | | | | | | | | | | |
| 6.8 | According to protection against corrosive or contaminating substances | - | - | - | - | - | - | - | 2 | - | - | 2 | 2 | 3 |
| 6.9 | According to the fastening type of the system duct cover | | | | | | | | | | | | | |
| 6.9.1 | Open the duct cover of the electrical installation duct system without tools | x | x | x | | x | x | | | | | | | |
| 6.9.2 | Only open the duct cover of the electrical installation duct system with tools | | | | | | x | x | x | x | x | x | x | x |
| 6.10 | According to the electrical protection separation | | | | | | | | | | | | | |
| 6.10.1 | Electrical installation duct systems without internal protection separation element | x | | x | | x | x | | | | | x | x | x |
| 6.10.2 | Electrical installation duct systems with internal protection separation element | | x | | x | | | x | x | x | x | | | |

x appropriate classification, *2 medium protection, *3 high protection, * in the system with accessories made from PVC/ABS, otherwise IP 30, 2 medium protection, 3 high protection

Classification to EN 50085-2-1

| | | WDK cable duct | WDKH cable duct | LKM cable routing trunking | SKL skirting duct | VK wiring duct | VKH wiring duct | Rapid 45-2 GK PVC device installation duct | Rapid 45-2 GA aluminium device installation duct | Rapid 80 GK PVC device installation duct | Rapid 80 GKH PC/ABS device installation duct | Rapid 80 GS steel device installation duct | Rapid 80 GA aluminium device installation duct | ISS industrial service pole |
|-----------|---|----------------|-----------------|----------------------------|-------------------|----------------|-----------------|--|--|--|--|--|--|-----------------------------|
| 6.101.3 | Depending on the type of floor care. Service poles for dry floor cleaning. | | | | | | | | | | | | | |
| 6.101.3.1 | Concealed/surface-mounded electrical installation trunking on the wall. | x | x | x | | | | x | x | x | x | x | x | |
| 6.101.3.2 | Concealed/surface-mounded electrical installation trunking on the ceiling. | x | x | x | | | | x | x | x | x | x | x | |
| 6.101.3.3 | Electrical installation duct on the wall and supported by the base. | | | | | | | | | | | | | |
| 6.101.3.4 | Electrical installation duct on the wall and supported by a different horizontal surface than the floor. | | | | x | | | | | | | | | |
| 6.101.4 | Electrical installation duct system, mounted at a distance to the wall or ceiling with fastenings | | | | | | | x | x | | | | | |
| 6.102 | According to the protection against contact between liquids, insulated cables and parts carrying voltage in the case of skirting ducts and wet cleaning of the floor | | | | | | | | | | | | | |
| 6.102.1 | No data | | | | | | | | | | | | | |
| 6.102.2 | Add to the instructions of the manufacturer, which limit the installation position of the electrical installation trunking system. | | | | | | | | | | | | | |
| 6.102.3 | Build to the instructions of the manufacturer, which allow all the installations of the electrical installation duct system, but limits the layers of insulated cables and parts carrying voltage in the electrical installation duct system. | | | | | | | | | | | | | |
| 6.102.4 | Build to the instructions of the manufacturer, which allow all the installations of the electrical installation duct system and allows the layers of insulated cables and parts carrying voltage in the electrical installation duct system. | | | | | | | | | | | | | |
| 6.103 | According to type | | | | | | | | | | | | | |
| 6.103.1 | Type 1 Electrical installation duct system | | x | x | x | | | | | | | | | |
| 6.103.2 | Type 2 Electrical installation duct system (distribution electrical installation duct system) | | | | | | | | | | | | | |
| 6.103.3 | Type 3 Electrical installation duct system (installation electrical installation duct system) | x | | | | x | x | x | x | x | x | x | x | |

x appropriate classification





A = very good resistance
 B = average resistance
 C = not resistant

A = very good resistance
 B = average resistance
 C = not resistant

| Medium | Temp. °C | Resistance |
|--|-------------|------------|
| 1,3-benzole disulphonic acid | 20 | A |
| 1,3-butadiene | 20 | A |
| 2,4-chlorobenzoyl chloride | 20 | A |
| 2-amino-2,2-diphenylacetic acid | 20 | A |
| 4-chlorine-2-nitroaniline | 20 | C |
| 4-chlorobenzaldehyde-2-sulphonic acid | 20 | A |
| 5-amino-2-hydroxybenzoic acid | 20 | A |
| Abietic acid | 20 | A |
| Acetaldehyde 100% | 20 | C |
| Acetaldehyde 40% | 20 | A |
| Acetaldehyde 40% | 40 | B |
| Acetaldehyde, acetic acid ratio 90:10 | 20 | B |
| Acetanilide 100% | 20 | A |
| Acetates (ammonium-, Na- and others) | 50 | A |
| Acetic acid 10% | 60 | A |
| Acetic acid 100% | 20 | A |
| Acetic acid 100% | 60 | B |
| Acetic acid 25% | 40 | A |
| Acetic acid 25-70% | 40 | A |
| Acetic anhydride | 20 | C |
| Acetone | 20 | C |
| Acetophenone (methyl phenyl ketone) | 20 | C |
| Acetylacetone (2,4-pentanedione) | 20 | C |
| Acetylene 100% | 20 | B |
| Acetylsalicylic acid | 20 | A |
| Adipic acid | 20 | A |
| Adipic acid | 60 | B |
| Alcoholic drinks | < 40 | A |
| Alizarin 100% | 20 | A |
| Alkanoic sulphonic acids | 50 | A |
| Allyl alcohol 100% | 20 | B |
| Allyl alcohol 100% | 60 | C |
| Allyl chloride | 20 | C |
| Aminobenzene (p-) | 20 | A |
| Aminobenzenesulphonic acid (m-, o-, p-) | 20 | A |
| Aminosalicic acid (p-) | 20 | A |
| Ammonia (vapours of all concentrations) | 40 | A |
| Ammonia (vapours of all concentrations) | 60 | B |
| Ammonia, anhydrous, liquid | < 60 | B |
| Ammonium hydroxide | 60 | A |
| Aniline 100% | 20 | A |
| Aniline chloride, saturated solution | 20 | C |
| Apple juice | 60 | A |
| Ascorbic acid | 20 | A |
| Aspartic acid | 20 | A |
| Beer | 60 | A |
| Benzine, containing benzole | 20 | C |
| Benzine, free from aromatic hydrocarbons | 60 | A |
| Benzoic acid | 40 | A |
| Benzoic anhydride | 30 | A |
| Benzole | 20 | C |
| Benzophenone 100% | 20 | C |
| Benzosulphonic acid | 60 | A |
| Benzotrifluoride | 20 | C |
| Benzotrifluoride | 20 | C |
| Benzoylbenzoic acid | 20 | A |
| Benzyl chloride | 20 | C |
| Betene | 20 | A |
| Bleaching liquor, 12% active chlorine | 40 | A |
| Bleaching liquor, 12% active chlorine | 60 | B |
| Blood | 40 | A |
| Boiled oil | 60 | C |
| Borates (NA-) | 20 | A |
| Borax | 40 | A |
| Boric acid | 20 | A |
| Brewer's wort | 20 | A |
| Brine | 60 | A |
| Bromates (K-, Na-) | 40 | A |
| Bromic acid | 20 | A |
| Bromides (K-, Na- and others) | 60 | A |
| Bromine water | 20 | A |
| Bromine, gaseous, dry | 20 | A |
| Bromine, liquid | 20 | C |
| Bromobenzene | 20 | C |
| Bromochloromethane | 20 | C |
| Bromochloropropane | 20 | C |
| Bromoform 100% | 20 | C |
| Butane, gaseous, 30% | 20 | A |
| Butanediol over 60% | 40 | B |
| Butanediol over 60% | 20 | C |
| Butanediol to 10% | 20 | A |
| Butanol | 60 | A |
| Buttermilk | 20 | A |
| Butyl acetate | 20 | C |
| Butyl butyrate | 20 | C |
| Butyl chloride | 20 | C |
| Butyl glycolate | 20 | C |

| Medium | Temp. °C | Resistance |
|---|-------------|------------|
| Butyl phenols | 20 | C |
| Butyric acid 100% | 20 | C |
| Butyric acid 20% | 20 | A |
| Butyric acid 20% | 60 | C |
| Carbon dioxide | 60 | A |
| Carbon disulphide 100% | 20 | B |
| Carbon monoxide | 60 | A |
| Castor oil | 60 | A |
| Chlorates (K-, Na- and others) | 20 | A |
| Chlorates (K-, Na- and others) | 60 | B |
| Chlorates (K-, Na- and others) | 60 | A |
| Chloric acid to 20% | 40 | A |
| Chloric acid to 20% | 60 | B |
| Chlorides (ammonium-, Na- and others) | 20 | A |
| Chlorine cyanide | 20 | A |
| Chlorine water (saturated solution) | 20 | B |
| Chlorine, gaseous, dry 0.5% | 20 | A |
| Chlorine, gaseous, dry 100% | 20 | B |
| Chlorine, gaseous, moist 5% | 20 | B |
| Chlorine, liquid | 20 | C |
| Chloro nitrobenzoic acid | 20 | A |
| Chloroacetaldehyde | 20 | C |
| Chloroacetic acid | 20 | A |
| Chloroacetones | 20 | C |
| Chloroacetyl chloride | 20 | C |
| Chloroaniline | 20 | C |
| Chlorobenzaldehyde | 20 | C |
| Chlorobenzene | 20 | C |
| Chlorobenzotrifluoride | 20 | C |
| Chlorobenzoyl chloride | 20 | C |
| Chlorocresole | 20 | C |
| Chloroethylbenzene | 20 | C |
| Chloroform | 20 | C |
| Chloronaphthalene | 20 | C |
| Chromates (K-, Na- to 50%) | 50 | A |
| Chrome alum | 60 | A |
| Chromic acid | 30 | A |
| Chromic acid to 50% | 40 | A |
| Citrates (ammonium-, Na) | 20 | A |
| Citric acid | 20 | A |
| Citric acid | 60 | B |
| Cresol | 20 | C |
| Cumene | 20 | C |
| Cyanamide | 20 | A |
| Cyanides (K-, Na- to 50%) | 60 | A |
| Cyanoacetic acid | 20 | C |
| Cyclohexanol | 20 | C |
| Cyclohexanone | 20 | C |
| Developer | 40 | A |
| Dextrose | 50 | A |
| Dibromomethylene | 20 | C |
| Dibutyl oxalate | 20 | C |
| Dibutyl phthalate | 20 | C |
| Dichloroethylene | 20 | C |
| Dichloropropylene | 20 | C |
| Dichromates (K-, Na-) | 50 | C |
| Diethyl ether | 20 | C |
| Diethylamine 100% | 20 | C |
| Diethylene glycol | 60 | C |
| Dimethyl ether | 20 | C |
| Di-n-butyl ether | 20 | C |
| Diethyl phthalate | 20 | C |
| Dioxan | 20 | C |
| Diphenyl | 20 | C |
| Diphenylamine | 20 | C |
| Ethane | 20 | A |
| Ethanol | 40 | A |
| Ethanolamine | 20 | B |
| Ethyl acetate | 20 | C |
| Ethyl acrylate | 20 | C |
| Ethyl chloride | 20 | C |
| Ethylbenzene | 20 | C |
| Ethylene glycol | 20 | A |
| Fish oil | 20 | A |
| Fixing bath | 60 | A |
| Fluorides (ammonium-, K-, Na- and others) | 60 | A |
| Fluorine | 20 | B |
| Fluorine | 60 | C |
| Formaldehyde | 60 | A |
| Formamide 100% | 20 | C |
| Formates (ammonium- and others) | 20 | A |
| Formic acid 100% | 20 | B |
| Formic acid 100% | 60 | C |
| Formic acid 50% | 40 | A |
| Furfural | 20 | C |
| Furfuryl alcohol | 20 | C |
| Gelatine | 60 | A |

A = very good resistance
 B = average resistance
 C = not resistant

A = very good resistance
 B = average resistance
 C = not resistant



















| Medium | Temp. °C | Resistance |
|--|-------------|------------|
| Gluconic acid | 20 | A |
| Glucose | 60 | A |
| Glutamic acid | 20 | A |
| Glycerine | 60 | A |
| Glycine | 40 | A |
| Glycol | 60 | A |
| Heptanes | 20 | A |
| Hexachloroethane | 20 | C |
| Hexacyanoferrates-II (Na-) | 40 | A |
| Hexacyanoferrates-III (K-) | 40 | A |
| Hexafluorosilicates (ammonium-, K- and others) | 60 | A |
| Hexafluorosilicic acid 32% | 60 | A |
| Hexamethylenetetramine (urotropine) 40% aqueous solution | 60 | A |
| Humic acids | 20 | A |
| Hydrazine, diluted solution 100% | 20 | C |
| Hydrazine, diluted solution 30% | 20 | A |
| Hydrobromic acid to 40% | 60 | A |
| Hydrochloric acid to 30% | 20 | A |
| Hydrochloric acid to 30% | 60 | B |
| Hydrochloric acid to 37% | 20 | A |
| Hydrochloric acid to 37% | 40 | B |
| Hydrofluoric acid to 40% | 40 | A |
| Hydrofluoric acid to 60% | 60 | B |
| Hydrofluoric acid to 60% | 60 | B |
| Hydrogen bromide 100% | 20 | A |
| Hydrogen bromide 100% | 60 | B |
| Hydrogen chloride (gaseous, dry and moist) | 40 | A |
| Hydrogen cyanide | 40 | A |
| Hydrogen peroxide to 30% | 60 | A |
| Hydrogen peroxide to 90% | 20 | A |
| Hydrogen sulphide | 60 | A |
| Hydroxides (alkaline-earth metal) | 60 | A |
| Hydroxides (K-, Na-) | 60 | A |
| Hypochlorites (K-, Na- and others) | 60 | A |
| Hypochlorous acid | 60 | A |
| illuminating gas | 20 | A |
| Iodates (K-, Na- and others) | 60 | A |
| Iodides (K-, Na-) | 60 | A |
| Iodine | 20 | C |
| Isobutyl phosphate | 20 | C |
| Lactic acid 10% | 20 | A |
| Lactic acid 10% | 60 | C |
| Lactic acid 100% | 20 | C |
| Lard | 20 | A |
| Linoleic acid | 60 | A |
| Linseed oil | 60 | A |
| Malic acid | 20 | A |
| Methanol 100% | 40 | A |
| Methanol 100% | 60 | B |
| Methyl bromide | 20 | C |
| Methyl chloride | 20 | C |
| Methyl methacrylate | 20 | C |
| Methylamine | 20 | B |
| Methylene dichloride | 20 | C |
| Milk | 20 | A |
| Mineral oils | 60 | C |
| N,N-diethyl aniline | 20 | C |
| Naphthalene | 20 | C |
| Nitrates (ammonium-, K-, Na- and others) | 60 | A |
| Nitric acid 25% | 20 | A |
| Nitric acid 25% | 60 | B |
| Nitric acid 50% | 20 | A |
| Nitric acid 50% | 50 | B |
| Nitric acid 95% | 20 | C |
| Nitrites (K-, Na- and others) | 60 | A |
| Nitrobenzene | 20 | C |
| Nitrogen oxide | 20 | C |
| Nitroglycerine | 20 | B |
| Nitrous acid to 50% | 50 | A |
| Nitrous acid to 98% | 20 | C |
| Oleic acid | 60 | A |
| Oxalates (ammonium-, K-, Na- and others) | 60 | A |
| Oxalic acid | 40 | A |
| Oxygen | 60 | A |
| Ozone 10% | 30 | A |
| Ozone 10% | 60 | B |
| Palmitic acid | 20 | A |
| Paraffin | 40 | A |
| Pentyl acetate | 20 | C |
| Pentyl alcohol | 60 | A |
| Pentyl chloride | 20 | C |
| Pentyl laurate | 20 | C |
| Perbonate (K-) | 60 | A |
| Perchlorate | 40 | A |
| Perchloric acid 70% | 20 | A |
| Permanganate (K-) 6 to 15% | 40 | A |

| Medium | Temp. °C | Resistance |
|--|-------------|------------|
| Permanganate (K-) 6 to 15% | 60 | B |
| Permanganate (K-) to 6% | 60 | A |
| Peroxymonosulphuric acid (Caro's acid) | 20 | A |
| Persulphate (Ammonium-, K-, Na- and others) | 40 | A |
| Petroleum | 60 | A |
| Phenol 1% | 20 | A |
| Phenol 90% | 45 | B |
| Phenylhydrazine | 20 | C |
| Phenylhydrazine chloride | 20 | B |
| Phenylhydrazine chloride | 60 | C |
| Phosgene, gaseous | 20 | A |
| Phosgene, gaseous | 60 | B |
| Phosgene, liquid | 20 | C |
| Phosphates (ammonium-, K-, Na- and others) | 60 | A |
| Phosphoric acid | 40 | A |
| Phosphoric acid | 60 | B |
| Phosphorus pentoxide | 20 | A |
| Propane | 20 | A |
| Propanol | 60 | A |
| Pyridine | 20 | A |
| Rhodanides (ammonium-, K-, Na- and others) | 60 | A |
| Salicylic acid | 20 | A |
| Silicates (K-) | 20 | A |
| Soap solution | 40 | A |
| Stearic acid | 60 | A |
| Sulphates (ammonium-, K-, Na- and others) | 60 | A |
| Sulphites (ammonium-, K-, Na- and others) | 60 | A |
| Sulphur dioxide, gaseous, dry and moist 100% | 60 | A |
| Sulphuric acid to 40% | 20 | C |
| Sulphuric acid to 50% | 50 | A |
| Sulphuric acid to 50% | 60 | A |
| Sulphuric acid to 80% | 40 | C |
| Sulphuric acid to 80% | 60 | B |
| Sulphuric acid to 96% | 20 | A |
| Sulphuric acid to 96% | 60 | B |
| Sulphuric acid, fuming (10% oleum) | 20 | C |
| Sulphurous acid | 60 | A |
| Tallow | 60 | A |
| Tan bark | 20 | A |
| Tar, free from aromatic hydrocarbons | 20 | A |
| Tartaric acid | 60 | A |
| Tetraethyl lead | 60 | A |
| Tetrafluoroboric acid | 20 | A |
| Tetrahydrofuran | 20 | C |
| Thickness | 60 | A |
| Toluene | 20 | A |
| Transformer oil | 60 | A |
| Trichloroethylene | 20 | C |
| Turpentine | 20 | A |
| Urea | 60 | C |
| Vegetable oils | 40 | A |
| Vinyl acetate | 20 | C |
| Viscose spinning solutions | 60 | A |
| Water | 40 | A |
| Water | 60 | B |
| Wine | 40 | A |
| Wine vinegar | 50 | A |
| Wood tar | 20 | C |
| Xylenes | 20 | C |



Plastic cable routing trunking

| | | |
|---|---|-----|
|  | Mini trunking | 32 |
|  | Nominal height 10 | 40 |
|  | Nominal height 12 | 42 |
|  | Nominal height 13 | 46 |
|  | Nominal height 15 | 50 |
|  | Nominal height 18 | 56 |
|  | Nominal height 20 | 58 |
|  | Nominal height 25 | 66 |
|  | Nominal height 30 | 70 |
|  | Nominal height 40 | 74 |
|  | Nominal height 60 | 82 |
|  | Nominal height 80 | 98 |
|  | Nominal height 100 | 102 |
|  | Accessories, plastic cable routing trunking | 106 |
|  | Universal trunking | 116 |
|  | Corner trunking | 118 |

System description



WDK trunking is particularly suited for areas in which appearance is not a key factor – for example, workshops, production facilities and residential cellars. Devices of width 60110 to 60210 can be installed in the PVC wall and ceiling trunking. All the standard devices of all

manufacturers fit the device installation sockets. A wide range of fittings guarantees solutions for all kinds of applications. The trunking, made of halogen-free material, guarantees compliance with the highest safety standards.

Installation principle



| | |
|----|---|
| 1 | Trunking |
| 2 | Joint cover |
| 3 | Internal corner hood |
| 4 | External corner cover |
| 5 | T and cross piece cover |
| 6 | Flat angle cover |
| 7 | End piece |
| 8 | Partition |
| 9 | Cover for single accessory mounting box |
| 10 | Accessory mounting box |

Mounting aid

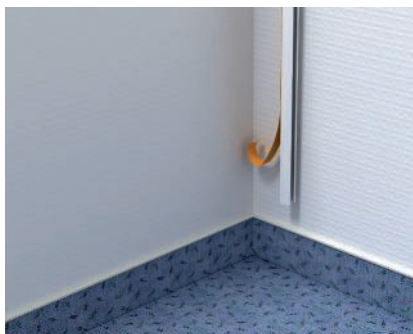

Mounting of mini trunking

Remove the protective film. Stick the trunking to a dust-free, adherent substrate.

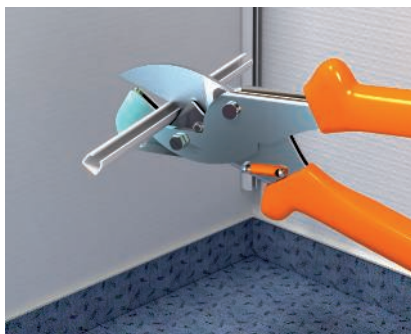

Cut mini trunking

The OBO shears can be used to create an exact straight cut for the WDK trunking. The shears can be used for trunking sizes of up to 25 x 45 mm.



WDK for workshops

Together with accessory mounting boxes, WDK cable trunking of 60 mm trunking height can be used as device installation trunking.



WDK with nail strip

The nail strip means that WDK trunking can be mounted with steel nails. At the same time, it prevents nail damage to the cables. Of course, the nail strip can also be used as a separating retainer for routing different voltage levels.



Mounting of cover clip

The cover clip is locked into the cover contour. To insert the cables, move it forward through 30°. The clip stabilises the WDK trunking and keeps the cables in the trunking.



Internal corner cover mounting

The cover fitting is placed over the mounted WDK trunking and locks into the cover contour.

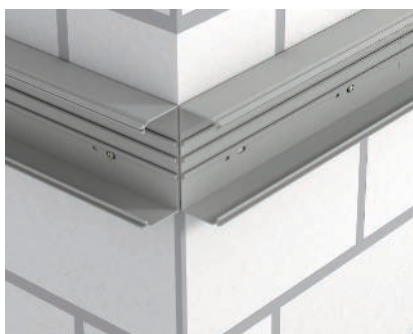

External corner hood mounting

The bases of the WDK trunking are mounted on the wall up to the corner.

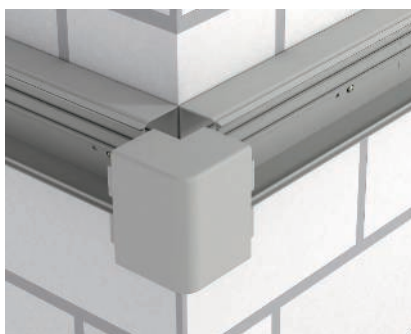

External corner hood mounting

After the cables have been routed, the external hood fitting is placed on the bases.



Mounting of accessory mounting box

The accessory mounting box is locked onto the floor connectors.



Mounting of accessory mounting box

Then the accessory mounting box is fixed to the WDK trunking using the bolt located in the base.



Mounting with nail device

Mounting of the cable trunking is fast and efficient with a Spit nail device.



RK universal trunking

The universal trunking hides the cables inserted in distributors and counter cabinets.



RK clip mounting

The clips (OBO Quick Clip Pg16) are mounted using knock-in anchors on the left and right of the distributor cabinets. They are contained in the scope of delivery.

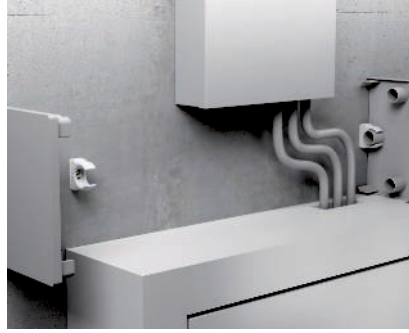

RK end piece mounting

The end pieces are fastened by locking them in the clips.



Cut RK cover

The covers are cut to the appropriate length using a standard coping saw.



RK cover mounting

Simply lock the cover in the end pieces.



RK front cover mounting

Attach the front cover to the cover clips.



RK complete mounting

The universal trunking allows tidy laying, even if a lot of cables need to be hidden.

Mini trunking with adhesive film and hinged cover MD4

PVC

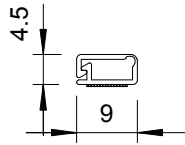

| Type | Colour | Length mm | Pack m | Weight kg/100 m | Item no. |
|----------|------------|--------------|-----------|--------------------|----------|
| WDKMD4RW | Pure white | 2000 | 2 | 3.300 | 6150268 |

Mini trunking with adhesive film and hinged cover.

Mini trunking with adhesive film and hinged cover MD7

PVC

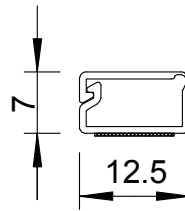

| Type | Colour | Length mm | Pack m | Weight kg/100 m | Item no. |
|----------|------------|--------------|-----------|--------------------|----------|
| WDKMD7RW | Pure white | 2000 | 2 | 5.000 | 6150276 |

Mini trunking with adhesive film and hinge cover.

Mini trunking with adhesive film and hinged cover MD12

PVC

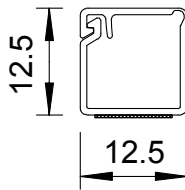

| Type | Colour | Length mm | Pack m | Weight kg/100 m | Item no. |
|-----------|------------|--------------|-----------|--------------------|----------|
| WDKMD12RW | Pure white | 2000 | 2 | 7.000 | 6150284 |

Mini trunking with adhesive film and hinged cover.

Mini trunking with adhesive film and hinged cover MD17

PVC

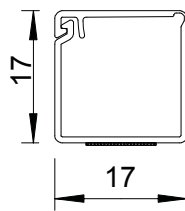
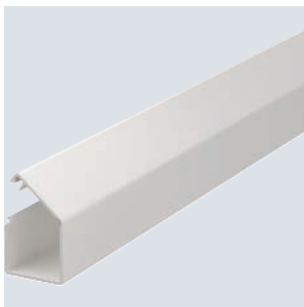

| Type | Colour | Length mm | Pack m | Weight kg/100 m | Item no. |
|-----------|------------|--------------|-----------|--------------------|----------|
| WDKMD17RW | Pure white | 2000 | 2 | 9.000 | 6150292 |

Mini trunking with adhesive film and hinged cover.

PVC



Mini trunking with adhesive film and hinge cover MD4

| Type | Colour | Length mm | Pack m | Weight kg/100 m | Item no. |
|----------|--------|--------------|-----------|--------------------|----------|
| WDKMD4CW | Cream | 2000 | 224 | 3.300 | 6150152 |

Mini trunking with adhesive film and hinged cover.

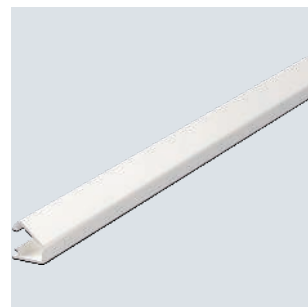
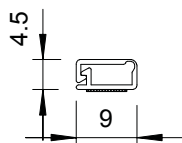

PVC



Mini trunking with adhesive film and hinge cover MD7

| Type | Colour | Length mm | Pack m | Weight kg/100 m | Item no. |
|----------|------------|--------------|-----------|--------------------|----------|
| WDKMD7CW | Cream | 2000 | 100 | 5.000 | 6150160 |
| WDKMD7S | Pure white | 2000 | 100 | 5.000 | 6150326 |

Mini trunking with adhesive film and hinge cover.

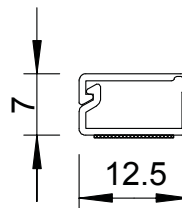

PVC



Mini trunking with adhesive film and hinge cover MD12

| Type | Colour | Length mm | Pack m | Weight kg/100 m | Item no. |
|-----------|------------|--------------|-----------|--------------------|----------|
| WDKMD12CW | Cream | 2000 | 80 | 7.000 | 6150179 |
| WDKMD12S | Pure white | 2000 | 80 | 7.000 | 6150330 |

Mini trunking with adhesive film and hinged cover.

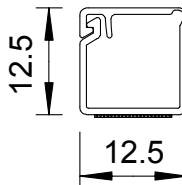

PVC



Mini trunking with adhesive film and hinge cover MD12

| Type | Colour | Length mm | Pack m | Weight kg/100 m | Item no. |
|----------|------------|--------------|-----------|--------------------|----------|
| WDKMD12S | Pure white | 2000 | 80 | 7.000 | 6150330 |

Mini trunking with adhesive foam film and hinge cover.

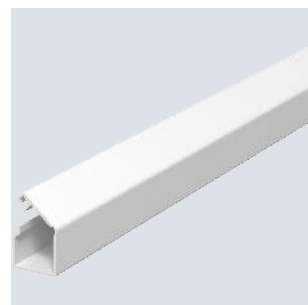
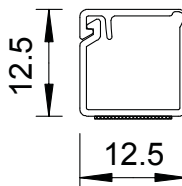

Mini trunking with hinged cover

Mini trunking with adhesive film and hinge cover MD17

PVC

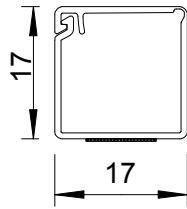

| Type | Colour | Length mm | Pack m | Weight kg/100 m | Item no. |
|-----------|--------|--------------|-----------|--------------------|----------|
| WDKMD17CW | Cream | 2000 | 56 | 9.000 | 6150187 |

Mini trunking with adhesive film and hinge cover.

Mini trunking with adhesive film and hinge cover MD17

PVC

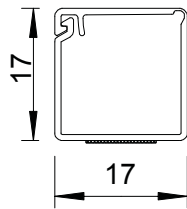
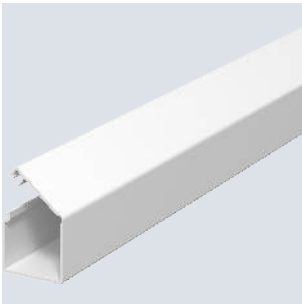

| Type | Colour | Length mm | Pack m | Weight kg/100 m | Item no. |
|----------|------------|--------------|-----------|--------------------|----------|
| WDKMD17S | Pure white | 2000 | 48 | 9.000 | 6150334 |

Mini trunking with adhesive foam film and hinge cover.



Trunking, type WDK 10030

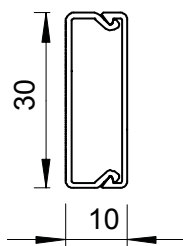

| Type | Colour | Length mm | Pack m | Weight kg/100 m | Item no. |
|------------|------------|--------------|-----------|--------------------|----------|
| WDK10030RW | Pure white | 2000 | 2 | 13.000 | 6150780 |
| WDK10030CW | Cream | 2000 | 64 | 13.000 | 6150772 |

Trunking cover and base with base perforation.

Joint cover, for trunking, type WDK 10030

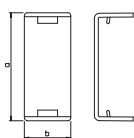

| Type | Colour | Dim. a mm | Dim. b mm | Pack Piece | Weight kg/100 pc. | Item no. |
|---------------|------------|-----------------|-----------------|---------------|----------------------|----------|
| WDK HS10030RW | Pure white | 32 | 14 | 10 | 0.115 | 6154034 |
| WDK HS10030CW | Cream | 32 | 14 | 10 | 0.115 | 6152015 |

Joint cover for smooth connection of trunking segments.

Internal corner cover, trunking type WDK 10030

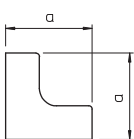
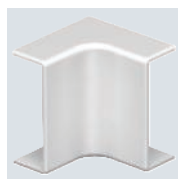

| Type | Colour | Dim. a mm | Pack Piece | Weight kg/100 pc. | Item no. |
|---------------|------------|-----------------|---------------|----------------------|----------|
| WDK HI10030RW | Pure white | 30 | 4 | 0.330 | 6154336 |
| WDK HI10030CW | Cream | 30 | 4 | 0.330 | 6153011 |

Internal corner cover for changing the direction of the WDK trunking.

External corner cover, trunking type WDK 10030

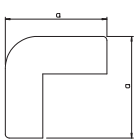

| Type | Colour | Dim. a mm | Pack Piece | Weight kg/100 pc. | Item no. |
|---------------|------------|-----------------|---------------|----------------------|----------|
| WDK HA10030RW | Pure white | 30 | 4 | 0.450 | 6154425 |
| WDK HA10030CW | Cream | 30 | 4 | 0.450 | 6153305 |

External corner cover for changing the direction of the WDK trunking.

Flat angle cover, trunking type WDK 10030

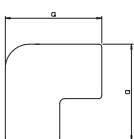

| Type | Colour | Dim. a mm | Pack Piece | Weight kg/100 pc. | Item no. |
|---------------|------------|-----------------|---------------|----------------------|----------|
| WDK HF10030RW | Pure white | 50 | 4 | 0.555 | 6154220 |
| WDK HF10030CW | Cream | 50 | 4 | 0.555 | 6152619 |

Flat angle hood for changing the direction of the WDK trunking.

PVC



T piece cover, for trunking type WDK 10030

| Type | Colour | Dim. | | Pack Piece | Weight kg/100 pc. | Item no. |
|---------------|------------|------|------|------------|-------------------|----------|
| | | a mm | b mm | | | |
| WDK HT10030RW | Pure white | 55 | 44 | 4 | 0.455 | 6154123 |
| WDK HT10030CW | Cream | 55 | 44 | 4 | 0.455 | 6152317 |

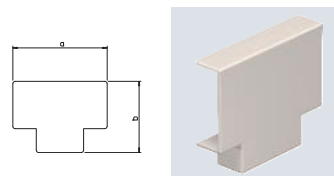

T piece cover for changing the direction of the WDK trunking.

PVC



End piece, trunking type WDK 10030

| Type | Colour | Dim. | | Pack Piece | Weight kg/100 pc. | Item no. |
|---------------|------------|------|------|------------|-------------------|----------|
| | | a mm | b mm | | | |
| WDK HE10030RW | Pure white | 32 | 11 | 10 | 0.139 | 6154522 |
| WDK HE10030CW | Cream | 32 | 11 | 10 | 0.139 | 6153607 |

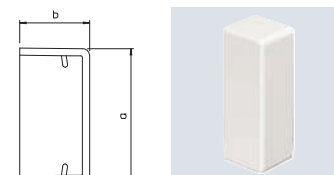

End piece to close the WDK trunking.

Trunking, type WDK 12022

PVC

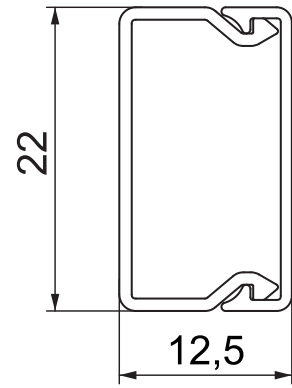
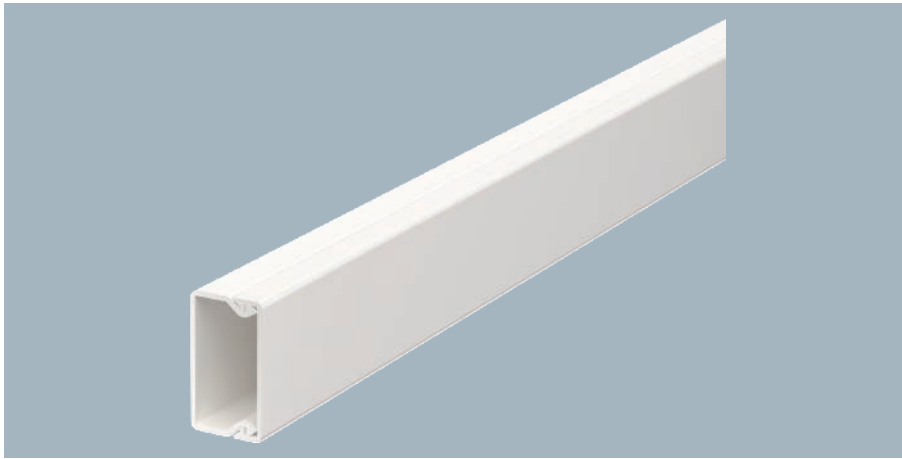

| Type | Colour | Length mm | Pack m | Weight kg/100 m | Item no. |
|------------|------------|--------------|-----------|--------------------|----------|
| WDK12022RW | Pure white | 2000 | 84 | 10.000 | 6150702 |

Trunking cover and base.

Trunking, type WDK 12022

PVC

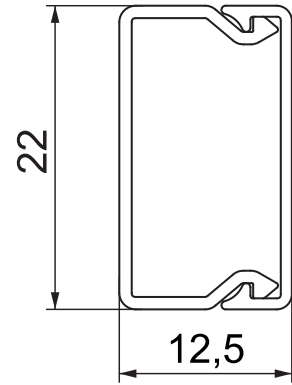
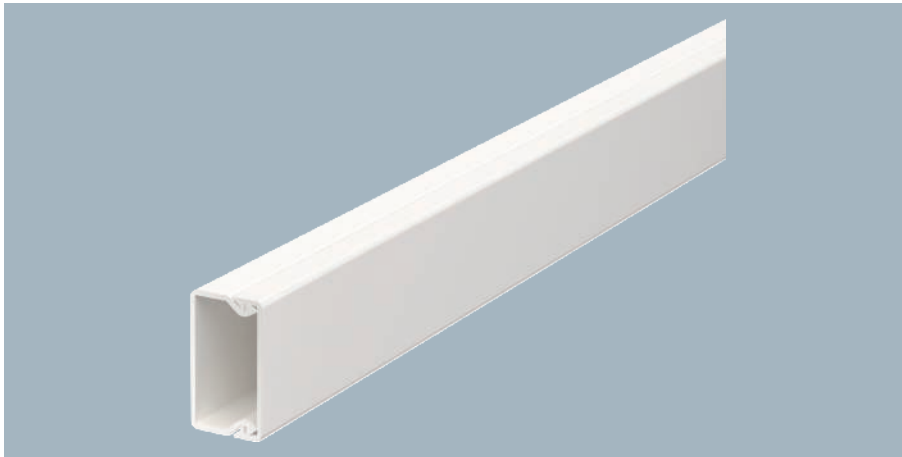

| Type | Colour | Length mm | Pack Piece | Weight kg/100 pc. | Item no. |
|-----------------|------------|--------------|---------------|----------------------|----------|
| WDK12022RW 2100 | Pure white | 2100 | 42 | 22.050 | 6150703 |

Trunking cover and base.

PVC

Trunking, type WDK 12022, with adhesive film

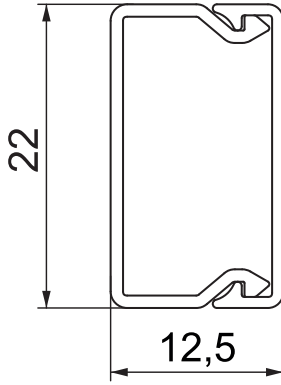

Trunking cover and base with adhesive film.

| Type | Colour | Length mm | Pack m | Weight kg/100 m | Item no. |
|------------------|------------|-----------|--------|-----------------|----------|
| WDK12022TRW | Pure white | 2000 | 72 | 11.000 | 6027300 |
| WDK12022TRW 2100 | Pure white | 2100 | 36 | 23.100 | 6027301 |

PC / ABS

Joint cover, for trunking type WDK 12022

| Type | Colour | Pack Piece | Weight kg/100 pc. | Item no. |
|---------------|------------|------------|-------------------|----------|
| WDK HS12022RW | Pure white | 10 | 0.084 | 6154042 |

Joint cover for smooth connection of trunking segments.

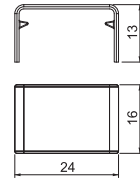

PC / ABS

Internal corner cover, for trunking type WDK 12022

| Type | Colour | Dim. a mm | Pack Piece | Weight kg/100 pc. | Item no. |
|---------------|------------|-----------|------------|-------------------|----------|
| WDK HI12022RW | Pure white | 33 | 4 | 0.286 | 6154342 |

Internal corner cover for changing the direction of the WDK trunking. The fitting can be adjusted variably.

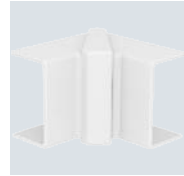
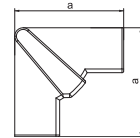

PC / ABS

External corner cover, for trunking type WDK 12022

| Type | Colour | Dim. a mm | Pack Piece | Weight kg/100 pc. | Item no. |
|---------------|------------|-----------|------------|-------------------|----------|
| WDK HA12022RW | Pure white | 27 | 4 | 0.260 | 6154432 |

External corner cover for changing the direction of the WDK trunking. The fitting can be adjusted variably.

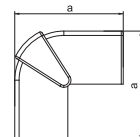

T piece cover, for trunking type WDK 12022

PC/
ABS

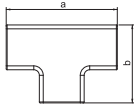

| Type | Colour | Dim. | | Pack Piece | Weight kg/100 pc. | Item no. |
|---------------|------------|------|------|------------|-------------------|----------|
| | | a mm | b mm | | | |
| WDK HT12022RW | Pure white | 60 | 42 | 4 | 0.374 | 6154132 |

T piece cover for changing the direction of the WDK trunking.

Flat angle cover, for trunking type WDK 12022

PC/
ABS

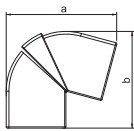

| Type | Colour | Dim. | | Pack Piece | Weight kg/100 pc. | Item no. |
|---------------|------------|------|------|------------|-------------------|----------|
| | | a mm | b mm | | | |
| WDK HF12022RW | Pure white | 39 | | 4 | 0.278 | 6154232 |

Flat angle cover for changing the direction of the WDK trunking. The fitting can be adjusted variably.

End piece, for trunking type WDK 12022

PC/
ABS

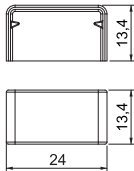
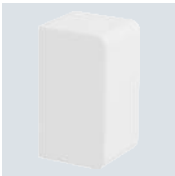

| Type | Colour | Dim. | | Pack Piece | Weight kg/100 pc. | Item no. |
|---------------|------------|------|------|------------|-------------------|----------|
| | | a mm | b mm | | | |
| WDK HE12022RW | Pure white | — | — | 10 | 0.107 | 6154532 |

End piece to close the WDK trunking.



Trunking, type WDK 13025

PVC

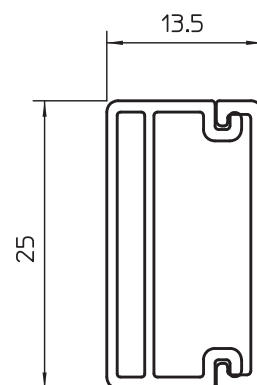
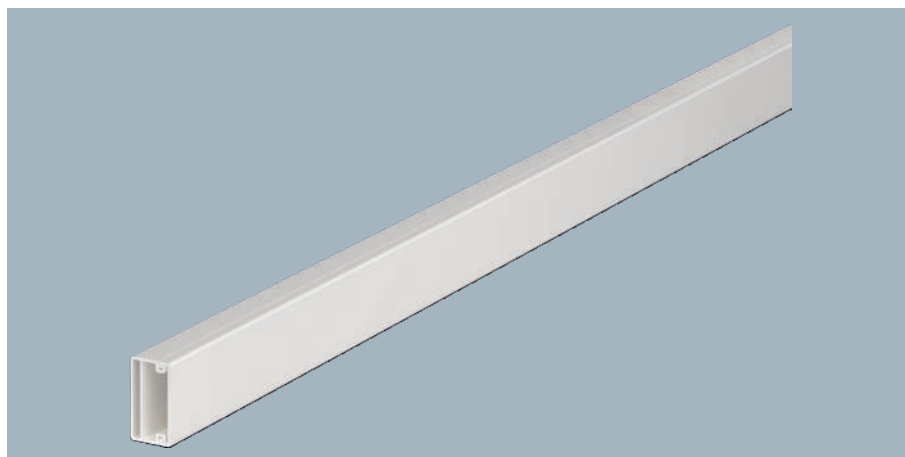

| Type | Colour | Length mm | Pack m | Weight kg/100 m | Item no. |
|----------|--------------|--------------|-----------|--------------------|----------|
| WDK13025 | Pure white | 2000 | 24 | 16.400 | 6187704 |
| WDK13025 | Oyster white | 2000 | 24 | 16.400 | 6187714 |

Trunking cover and base with base perforation. The heads of the fastening screws are hidden in the raised floor of the trunking. Assignment with cables with basic isolation is permitted. Please note the delivery lengths of 2 m and 4 m. Pure white = similar to RAL 9010, pearl white = similar to RAL 1013.

Joint cover, for trunking, type WDK 13025

PC / ABS

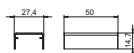

| Type | Colour | Width mm | Height mm | Pack Piece | Weight kg/100 pc. | Item no. |
|---------------|--------------|-------------|--------------|---------------|----------------------|----------|
| WDK HS13025RW | Pure white | 27.4 | 14.7 | 20 | 0.556 | 6193498 |
| WDK HS13025PW | Oyster white | 27.4 | 14.7 | 20 | 0.556 | 6193496 |

Joint cover for perfect connection of the WDK trunking segments, type 13025. Incl. coupling for the raised trunking floor.

Internal corner cover, for duct type WDK 13025

PC / ABS

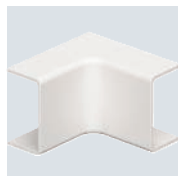

| Type | Colour | Width mm | Height mm | Pack Piece | Weight kg/100 pc. | Item no. |
|---------------|--------------|-------------|--------------|---------------|----------------------|----------|
| WDK HI13025RW | Pure white | 25 | 13 | 10 | 0.604 | 6191835 |
| WDK HI13025PW | Oyster white | 25 | 13 | 10 | 0.604 | 6191833 |

Internal corner hood for changing the direction of the WDK raised floor trunking, type 13025. Incl. coupling for the raised floor.

External corner cover, for trunking type WDK 13025

PC / ABS
CE UK CA ØE

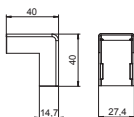

| Type | Colour | Pack Piece | Weight kg/100 pc. | Item no. |
|---------------|------------|---------------|----------------------|----------|
| WDK HA13025RW | Pure white | 10 | 0.707 | 6192141 |

External corner cover for changing the direction of the WDK raised floor trunking, type 13025. Incl. coupling for the raised floor.

PC/
ABS

External corner cover, for trunking type WDK 13025

| Type | Colour | Dim. a mm | Pack Piece | Weight kg/100 pc. | Item no. |
|---------------|--------------|-----------------|---------------|----------------------|----------|
| WDK HA13025PW | Oyster white | 50 | 10 | 0.707 | 6192139 |

External corner cover for changing the direction of the WDK raised floor trunking, type 13025. Incl. coupling for the raised floor.

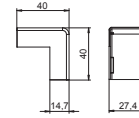

PC/
ABS

Flat angle cover, for duct type WDK 13025

| Type | Colour | Dim. a mm | Pack Piece | Weight kg/100 pc. | Item no. |
|---------------|--------------|-----------------|---------------|----------------------|----------|
| WDK HF13025PW | Oyster white | 50 | 10 | 0.800 | 6192740 |

Flat angle hood for changing the direction of the WDK trunking.

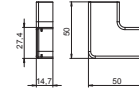

PC/
ABS



Flat angle cover, for duct type WDK 13025

| Type | Colour | Dim. a mm | Pack Piece | Weight kg/100 pc. | Item no. |
|---------------|------------|-----------------|---------------|----------------------|----------|
| WDK HF13025RW | Pure white | 50 | 10 | 0.800 | 6192742 |

Flat angle hood for changing the direction of the WDK trunking.

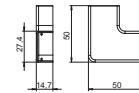

PC/
ABS

T piece cover, for trunking type WDK 13025

| Type | Colour | Width mm | Height mm | Pack Piece | Weight kg/100 pc. | Item no. |
|---------------|--------------|-------------|--------------|---------------|----------------------|----------|
| WDK HT13025RW | Pure white | 25 | 13 | 10 | 1.013 | 6192451 |
| WDK HT13025PW | Oyster white | 25 | 13 | 10 | 1.059 | 6192449 |

T piece cover for changing the direction of the WDK trunking.

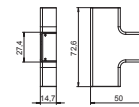

PC/
ABS

T piece cover, for trunking type WDK 13025

| Type | Colour | Width mm | Height mm | Pack Piece | Weight kg/100 pc. | Item no. |
|-----------------|--------------|-------------|--------------|---------------|----------------------|----------|
| WDK HTCW13025PW | Oyster white | 25 | 13 | 10 | 1.035 | 6192448 |
| WDK HTCW13025RW | Pure white | 25 | 13 | 10 | 1.035 | 6192450 |

T piece cover for changing the direction of the WDK trunking.

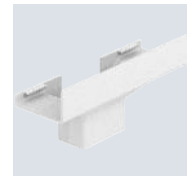
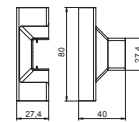

End piece, for trunking type WDK 13025

PC/
ABS



| Type | Colour | Pack Piece | Weight kg/100 pc. | Item no. |
|---------------|--------------|------------|-------------------|----------|
| WDK HE13025PW | Oyster white | 10 | 0.385 | 6193088 |

End piece to close the WDK trunking.

End piece, for trunking type WDK 13025

PC/
ABS
CEUK
CA D'E



| Type | Colour | Pack Piece | Weight kg/100 pc. | Item no. |
|---------------|------------|------------|-------------------|----------|
| WDK HE13025RW | Pure white | 10 | 0.385 | 6193093 |

End piece to close the WDK trunking.

Pipe adapter, trunking to pipe, 16 mm

PC/
ABS

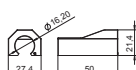

| Type | Colour | Pack Piece | Weight kg/100 pc. | Item no. |
|------------------|--------------|------------|-------------------|----------|
| WDK HPC13025RW16 | Pure white | 10 | 0.461 | 6193710 |
| WDK HPC13025PW16 | Oyster white | 10 | 0.461 | 6193708 |

Pipe adapter for transferring an installation pipe to the WDK trunking.

Pipe adapter, trunking to pipe, 19 mm

PC/
ABS

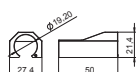

| Type | Colour | Pack Piece | Weight kg/100 pc. | Item no. |
|------------------|--------------|------------|-------------------|----------|
| WDK HPC13025RW19 | Pure white | 10 | 0.436 | 6193730 |
| WDK HPC13025PW19 | Oyster white | 10 | 0.436 | 6193728 |

Pipe adapter for transferring an installation pipe to the WDK trunking.

Pipe adapter, trunking to pipe, 20 mm

PC/
ABS



| Type | Colour | Pack Piece | Weight kg/100 pc. | Item no. |
|------------------|--------------|------------|-------------------|----------|
| WDK HPC13025RW20 | Pure white | 10 | 0.431 | 6193729 |
| WDK HPC13025PW20 | Oyster white | 10 | 0.431 | 6193731 |

Pipe adapter for transferring an installation pipe to the WDK trunking.



Trunking height 15 mm, trunking width 15 mm

Trunking, type WDK 15015

PVC

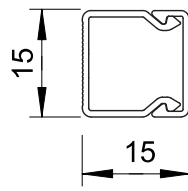

| Type | Colour | Length mm | Pack m | Weight kg/100 m | Item no. |
|-------------|-------------|--------------|-----------|--------------------|----------|
| WDK15015RW | Pure white | 2000 | 56 | 9.000 | 6191002 |
| WDK15015CW | Cream | 2000 | 56 | 9.000 | 6024963 |
| WDK15015LGR | Light grey | 2000 | 56 | 9.000 | 6024947 |
| WDK15015GR | Stone grey | 2000 | 56 | 9.000 | 6024955 |
| WDK15015BR | Sepia brown | 2000 | 56 | 9.000 | 6024971 |
| WDK15015SW | Jet black | 2000 | 56 | 9.000 | 6024949 |

Trunking cover and base with base perforation.

End piece, trunking type WDK 15015

PVC

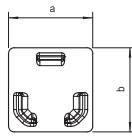

| Type | Colour | Dim. a mm | Dim. b mm | Pack Piece | Weight kg/100 pc. | Item no. |
|----------------|------------|-----------------|-----------------|---------------|----------------------|----------|
| WDK HE15015RW | Pure white | 15 | 15 | 10 | 0.082 | 6193099 |
| WDK HE15015CW | Cream | 15 | 15 | 10 | 0.081 | 6162495 |
| WDK HE15015LGR | Light grey | 15 | 15 | 10 | 0.081 | 6183603 |
| WDK HE15015GR | Stone grey | 15 | 15 | 10 | 0.081 | 6158692 |

End piece to close the WDK trunking.

PVC



Trunking, type WDK 15030

| Type | Colour | Length mm | Pack m | Weight kg/100 m | Item no. |
|----------------|-------------|-----------|--------|-----------------|----------|
| WDK15030RW | Pure white | 2000 | 32 | 19.500 | 6191010 |
| WDK15030CW | Cream | 2000 | 32 | 19.500 | 6025013 |
| WDK15030GR | Stone grey | 2000 | 32 | 19.500 | 6025005 |
| WDK15030BR | Sepia brown | 2000 | 32 | 19.500 | 6025021 |
| WDK15030LGR | Light grey | 2000 | 32 | 19.500 | 6025048 |
| WDK15030RW2500 | Pure white | 2000 | 798 | 48.750 | 6191013 |

Trunking cover and base with base perforation.

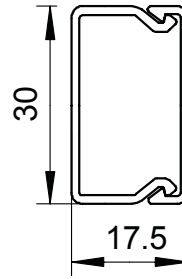

PVC



Trunking, type WDK 15030

| Type | Colour | Length mm | Pack m | Weight kg/100 m | Item no. |
|-------------|------------|-----------|--------|-----------------|----------|
| WDK15030SRW | Pure white | 2000 | 32 | 19.500 | 6027325 |

Trunking cover and base with adhesive film.

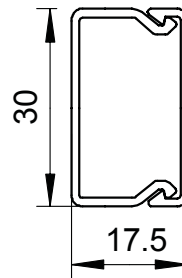

PVC



Joint cover, for trunking, type WDK 15030

| Type | Colour | Dim. a mm | Dim. b mm | Pack Piece | Weight kg/100 pc. | Item no. |
|---------------|------------|-----------|-----------|------------|-------------------|----------|
| WDK HS15030RW | Pure white | 32 | 14 | 10 | 0.136 | 6193501 |
| WDK HS15030CW | Cream | 32 | 14 | 10 | 0.136 | 6152031 |
| WDK HS15030GR | Stone grey | 32 | 14 | 10 | 0.136 | 6158838 |

Joint cover for smooth connection of trunking segments.

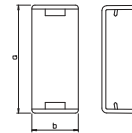

PVC



Internal corner cover, trunking type WDK 15030

| Type | Colour | Dim. a mm | Pack Piece | Weight kg/100 pc. | Item no. |
|---------------|------------|-----------|------------|-------------------|----------|
| WDK HI15030RW | Pure white | 38.5 | 4 | 0.789 | 6191843 |
| WDK HI15030CW | Cream | 38.5 | 4 | 0.790 | 6160026 |
| WDK HI15030GR | Stone grey | 38.5 | 4 | 0.790 | 6158234 |

Internal corner cover for changing the direction of the WDK trunking.

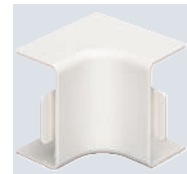
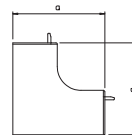

PVC



External corner cover, trunking type WDK 15030

| Type | Colour | Dim. a mm | Pack Piece | Weight kg/100 pc. | Item no. |
|---------------|------------|-----------|------------|-------------------|----------|
| WDK HA15030RW | Pure white | 38.5 | 4 | 1.114 | 6192149 |
| WDK HA15030CW | Cream | 38.5 | 4 | 1.096 | 6160611 |
| WDK HA15030GR | Stone grey | 38.5 | 4 | 1.114 | 6158358 |

External corner cover for changing the direction of the WDK trunking.

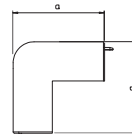

Flat angle cover, trunking type WDK 15030

PVC

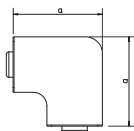

| Type | Colour | Dim. a mm | Dim. b mm | Pack Piece | Weight kg/100 pc. | Item no. |
|---------------|------------|-----------|-----------|------------|-------------------|----------|
| WDK HF15030RW | Pure white | 53 | | 4 | 0.965 | 6192750 |
| WDK HF15030CW | Cream | 53 | | 4 | 0.965 | 6161219 |
| WDK HF15030GR | Stone grey | 53 | | 4 | 0.965 | 6158595 |

Flat angle hood for changing the direction of the WDK trunking.

T piece cover, for trunking type WDK 15030

PVC

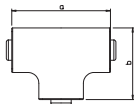

| Type | Colour | Dim. a mm | Dim. b mm | Pack Piece | Weight kg/100 pc. | Item no. |
|---------------|------------|-----------|-----------|------------|-------------------|----------|
| WDK HT15030RW | Pure white | 73 | 53 | 4 | 1.119 | 6192459 |
| WDK HT15030CW | Cream | 73 | 53 | 4 | 1.119 | 6161928 |
| WDK HT15030GR | Stone grey | 73 | 53 | 4 | 1.119 | 6158463 |

T piece cover for changing the direction of the WDK trunking.

End piece, trunking type WDK 15030

PVC

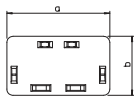

| Type | Colour | Dim. a mm | Dim. b mm | Pack Piece | Weight kg/100 pc. | Item no. |
|---------------|------------|-----------|-----------|------------|-------------------|----------|
| WDK HE15030RW | Pure white | 30 | 17 | 10 | 0.230 | 6193102 |
| WDK HE15030CW | Cream | 30 | 17 | 10 | 0.235 | 6162517 |
| WDK HE15030GR | Stone grey | 30 | 17 | 10 | 0.230 | 6158714 |

End piece to close the WDK trunking.

PVC



Trunking, type WDK 15040

| Type | Colour | Length mm | Pack m | Weight kg/100 m | Item no. |
|------------|------------|--------------|-----------|--------------------|----------|
| WDK15040RW | Pure white | 2000 | 36 | 23.000 | 6191029 |
| WDK15040CW | Cream | 2000 | 36 | 23.000 | 6025161 |
| WDK15040GR | Stone grey | 2000 | 36 | 23.000 | 6025137 |

Trunking cover and base with base perforation.

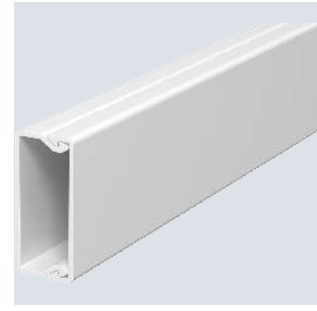
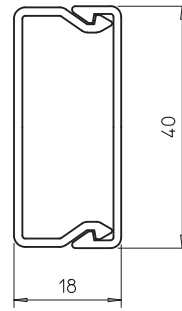

PVC



Trunking, type WDK 15040

| Type | Colour | Length mm | Pack m | Weight kg/100 m | Item no. |
|-------------|------------|--------------|-----------|--------------------|----------|
| WDK15040SRW | Pure white | 2000 | 36 | 27.000 | 6027335 |

Trunking cover and base with adhesive film.

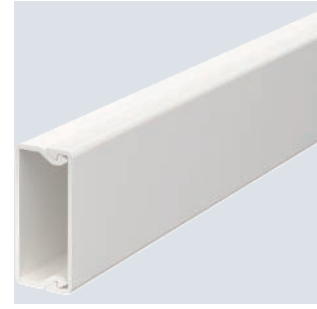
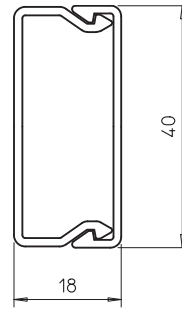

PVC



Joint cover, for trunking, type WDK 15040

| Type | Colour | Dim. a mm | Dim. b mm | Pack Piece | Weight kg/100 pc. | Item no. |
|---------------|------------|-----------------|-----------------|---------------|----------------------|----------|
| WDK HS15040RW | Pure white | 42 | 14 | 10 | 0.190 | 6193528 |
| WDK HS15040CW | Cream | 42 | 14 | 20 | 0.190 | 6152058 |
| WDK HS15040GR | Stone grey | 42 | 14 | 10 | 0.190 | 6158846 |

Joint cover for smooth connection of trunking segments.

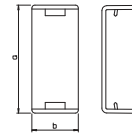

PVC



Internal corner hood, for trunking type WDK 15040

| Type | Colour | Dim. a mm | Pack Piece | Weight kg/100 pc. | Item no. |
|---------------|------------|-----------------|---------------|----------------------|----------|
| WDK HI15040RW | Pure white | 42 | 4 | 1.070 | 6191851 |
| WDK HI15040CW | Cream | 42 | 4 | 1.064 | 6160034 |
| WDK HI15040GR | Stone grey | 42 | 4 | 1.064 | 6158242 |

Internal corner cover for changing the direction of the WDK trunking.

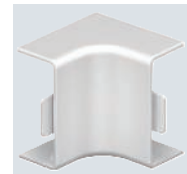
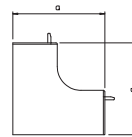

PVC



External corner cover, for trunking type WDK 15040

| Type | Colour | Dim. a mm | Pack Piece | Weight kg/100 pc. | Item no. |
|---------------|------------|-----------------|---------------|----------------------|----------|
| WDK HA15040RW | Pure white | 42 | 4 | 1.429 | 6192157 |
| WDK HA15040CW | Cream | 42 | 4 | 1.400 | 6160638 |
| WDK HA15040GR | Stone grey | 42 | 4 | 1.400 | 6158366 |

External corner hood for changing the direction of the WDK trunking.

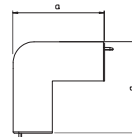

Flat angle cover, for trunking type WDK 15040

PVC

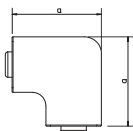

| Type | Colour | Dim. a mm | Dim. b mm | Pack Piece | Weight kg/100 pc. | Item no. |
|---------------|------------|-----------|-----------|------------|-------------------|----------|
| WDK HF15040RW | Pure white | 63 | | 4 | 1.471 | 6192769 |
| WDK HF15040CW | Cream | 63 | | 4 | 1.500 | 6161227 |
| WDK HF15040GR | Stone grey | 63 | | 4 | 1.500 | 6158609 |

Flat angle hood for changing the direction of the WDK trunking.

T piece cover, for trunking type WDK 15040

PVC

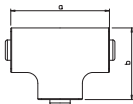

| Type | Colour | Dim. a mm | Dim. b mm | Pack Piece | Weight kg/100 pc. | Item no. |
|---------------|------------|-----------|-----------|------------|-------------------|----------|
| WDK HT15040RW | Pure white | 83 | 74 | 4 | 1.746 | 6192467 |
| WDK HT15040CW | Cream | 83 | 74 | 4 | 1.746 | 6161936 |
| WDK HT15040GR | Stone grey | 83 | 74 | 4 | 1.746 | 6158471 |

T piece cover for changing the direction of the WDK trunking.

End piece, trunking type WDK 15040

PVC

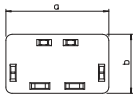
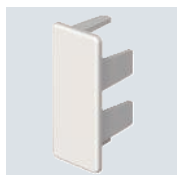

| Type | Colour | Dim. a mm | Dim. b mm | Pack Piece | Weight kg/100 pc. | Item no. |
|---------------|------------|-----------|-----------|------------|-------------------|----------|
| WDK HE15040RW | Pure white | 40 | 17 | 10 | 0.299 | 6193110 |
| WDK HE15040CW | Cream | 40 | 17 | 10 | 0.299 | 6162525 |
| WDK HE15040GR | Stone grey | 40 | 17 | 10 | 0.299 | 6158722 |

End piece to close the WDK trunking.



Cable routing trunking MKS 18, trunking width 45

PVC



| Type | Colour | Length mm | Width mm | Height mm | Pack Piece | Weight kg/100 pc. | Item no. |
|------------------------|------------|--------------|-------------|--------------|---------------|----------------------|----------------|
| MKS 1845 rws | Pure white | 2500 | 45 | 18 | 20 | 57.500 | 6131377 |
| MKS MFS 1845 KB | Pure white | 2500 | 45 | 18 | 23 | 57.500 | 6131380 |

MKS mini trunking for covered cable routing in internal areas.



Trunking, type WDK 20020 with base perforation

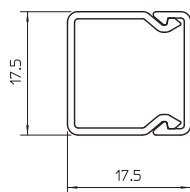

| Type | Colour | Length mm | Pack m | Weight kg/100 m | Item no. |
|-------------|-------------|--------------|-----------|--------------------|----------|
| WDK20020RW | Pure white | 2000 | 48 | 11.100 | 6191037 |
| WDK20020CW | Cream | 2000 | 48 | 11.100 | 6025153 |
| WDK20020LGR | Light grey | 2000 | 48 | 11.100 | 6025102 |
| WDK20020GR | Stone grey | 2000 | 48 | 11.100 | 6025110 |
| WDK20020BR | Sepia brown | 2000 | 48 | 11.100 | 6025129 |
| WDK20020SW | Jet black | 2000 | 48 | 11.000 | 6025155 |

Trunking cover and base with base perforation.

Trunking, type WDK 20020S with adhesive film

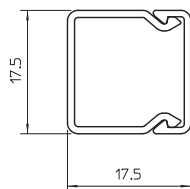

| Type | Colour | Length mm | Pack m | Weight kg/100 m | Item no. |
|-------------|------------|--------------|-----------|--------------------|----------|
| WDK20020SRW | Pure white | 2000 | 48 | 12.000 | 6027360 |

Trunking cover and base with base perforation.

Internal corner cover, trunking type WDK 20020

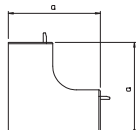
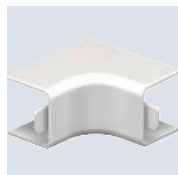

| Type | Colour | Dim. a mm | Pack Piece | Weight kg/100 pc. | Item no. |
|----------------|------------|-----------------|---------------|----------------------|----------|
| WDK HI20020RW | Pure white | 38.5 | 4 | 0.619 | 6191878 |
| WDK HI20020CW | Cream | 38.5 | 4 | 0.623 | 6160018 |
| WDK HI20020LGR | Light grey | 38.5 | 4 | 0.623 | 6182011 |
| WDK HI20020GR | Stone grey | 38.5 | 4 | 0.623 | 6158226 |

Internal corner cover for changing the direction of the WDK trunking.

External corner cover, trunking type WDK 20020

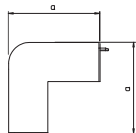
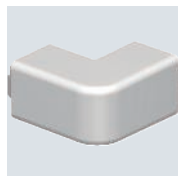

| Type | Colour | Dim. a mm | Pack Piece | Weight kg/100 pc. | Item no. |
|----------------|------------|-----------------|---------------|----------------------|----------|
| WDK HA20020RW | Pure white | 38.5 | 4 | 0.678 | 6192165 |
| WDK HA20020CW | Cream | 38.5 | 4 | 0.678 | 6160603 |
| WDK HA20020LGR | Light grey | 38.5 | 4 | 0.678 | 6182402 |
| WDK HA20020GR | Stone grey | 38.5 | 4 | 0.678 | 6158331 |

External corner cover for changing the direction of the WDK trunking.

PVC



Flat angle cover, trunking type WDK 20020

| Type | Colour | Dim. a mm | Pack Piece | Weight kg/100 pc. | Item no. |
|----------------|------------|-----------------|---------------|----------------------|----------|
| WDK HF20020RW | Pure white | 38 | 4 | 0.588 | 6192777 |
| WDK HF20020CW | Cream | 38 | 4 | 0.596 | 6161200 |
| WDK HF20020LGR | Light grey | 38 | 4 | 0.596 | 6183212 |
| WDK HF20020GR | Stone grey | 38 | 4 | 0.596 | 6158587 |

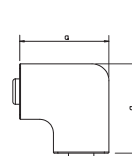

Flat angle cover for changing the direction of the WDK trunking.

PVC



T piece cover, for trunking type WDK 20020

| Type | Colour | Dim. a mm | Dim. b mm | Pack Piece | Weight kg/100 pc. | Item no. |
|----------------|------------|-----------------|-----------------|---------------|----------------------|----------|
| WDK HT20020RW | Pure white | 57 | 39 | 4 | 0.751 | 6192475 |
| WDK HT20020CW | Cream | 57 | 39 | 4 | 0.751 | 6161901 |
| WDK HT20020LGR | Light grey | 57 | 39 | 4 | 0.751 | 6182801 |
| WDK HT20020GR | Stone grey | 57 | 39 | 4 | 0.751 | 6158455 |

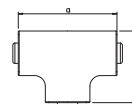

T piece cover for changing the direction of the WDK trunking.

PVC



End piece, trunking type WDK 20020

| Type | Colour | Dim. a mm | Dim. b mm | Pack Piece | Weight kg/100 pc. | Item no. |
|----------------|------------|-----------------|-----------------|---------------|----------------------|----------|
| WDK HE20020RW | Pure white | 17 | 17 | 10 | 0.103 | 6193129 |
| WDK HE20020CW | Cream | 17 | 17 | 10 | 0.101 | 6162509 |
| WDK HE20020LGR | Light grey | 17 | 17 | 10 | 0.101 | 6183611 |
| WDK HE20020GR | Stone grey | 17 | 17 | 10 | 0.101 | 6158706 |

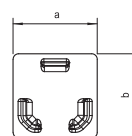

End piece to close the WDK trunking.

Trunking height 20 mm, trunking width 35 mm

Trunking, type WDK 20035

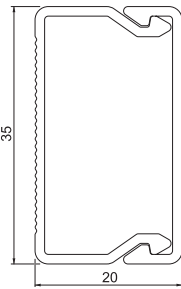

| Type | Colour | Length mm | Pack m | Weight kg/100 m | Item no. |
|-------------|------------|--------------|-----------|--------------------|----------|
| WDK20035RW | Pure white | 2000 | 32 | 23.900 | 6191045 |
| WDK20035CW | Cream | 2000 | 32 | 23.900 | 6026370 |
| WDK20035LGR | Light grey | 2000 | 32 | 23.900 | 6026354 |
| WDK20035GR | Stone grey | 2000 | 32 | 23.900 | 6026362 |

Trunking cover and base with base perforation.

End piece, trunking type WDK 20035

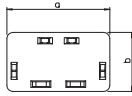
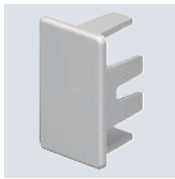

| Type | Colour | Dim. a mm | Dim. b mm | Pack Piece | Weight kg/100 pc. | Item no. |
|----------------|------------|-----------------|-----------------|---------------|----------------------|----------|
| WDK HE20035RW | Pure white | 35 | 20 | 10 | 0.334 | 6193137 |
| WDK HE20035CW | Cream | 35 | 20 | 10 | 0.334 | 6162487 |
| WDK HE20035LGR | Light grey | 35 | 20 | 10 | 0.334 | 6183654 |
| WDK HE20035GR | Stone grey | 35 | 20 | 10 | 0.334 | 6158781 |

End piece to close the WDK trunking.

PVC



Trunking, type WDK 20050

| Type | Colour | Length mm | Pack m | Weight kg/100 m | Item no. |
|------------|------------|--------------|-----------|--------------------|----------|
| WDK20050RW | Pure white | 2000 | 42 | 30.700 | 6168736 |
| WDK20050CW | Cream | 2000 | 42 | 30.700 | 6168701 |

Trunking cover and base with base perforation.

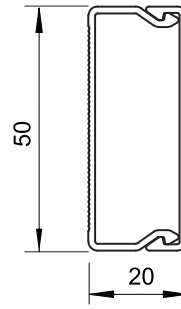

PVC



Trunking, type WDK-N 20050

| Type | Colour | Length mm | Pack m | Weight kg/100 m | Item no. |
|--------------|------------|--------------|-----------|--------------------|----------|
| WDK-N20050RW | Pure white | 2000 | 2 | 37.000 | 6168744 |
| WDK-N20050CW | Cream | 2000 | 2 | 37.000 | 6168728 |

Trunking cover and base with base perforation.

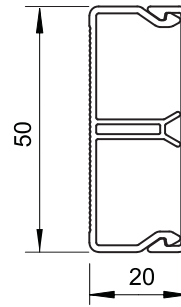

PVC



Joint cover, for trunking, type WDK 20050

| Type | Colour | Dim. a mm | Dim. b mm | Pack Piece | Weight kg/100 pc. | Item no. |
|---------------|------------|-----------------|-----------------|---------------|----------------------|----------|
| WDK HS20050RW | Pure white | 53 | 14 | 10 | 0.267 | 6154069 |
| WDK HS20050CW | Cream | 53 | 14 | 10 | 0.267 | 6152104 |

Joint cover for smooth connection of trunking segments.

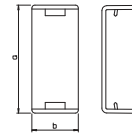

PVC



Internal corner cover, trunking type WDK 20050

| Type | Colour | Dim. a mm | Pack Piece | Weight kg/100 pc. | Item no. |
|---------------|------------|-----------------|---------------|----------------------|----------|
| WDK HI20050RW | Pure white | 45 | 4 | 1.277 | 6154360 |
| WDK HI20050CW | Cream | 45 | 4 | 2.500 | 6153089 |

Internal corner cover for changing the direction of the WDK trunking.

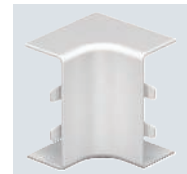
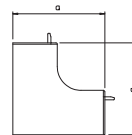

PVC



External corner cover, trunking type WDK 20050

| Type | Colour | Dim. a mm | Pack Piece | Weight kg/100 pc. | Item no. |
|---------------|------------|-----------------|---------------|----------------------|----------|
| WDK HA20050RW | Pure white | 45 | 4 | 1.765 | 6154468 |
| WDK HA20050CW | Cream | 45 | 4 | 3.000 | 6153372 |

External corner hood for changing the direction of the WDK trunking.

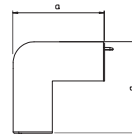

Trunking height 20 mm, trunking width 50 mm

Flat angle cover, trunking type WDK 20050

PVC

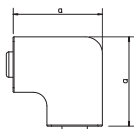

| Type | Colour | Dim. a mm | Pack Piece | Weight kg/100 pc. | Item no. |
|---------------|------------|-----------|------------|-------------------|----------|
| WDK HF20050RW | Pure white | 73 | 4 | 1.948 | 6154255 |
| WDK HF20050CW | Cream | 73 | 4 | 1.948 | 6152686 |

Flat angle hood for changing the direction of the WDK trunking.

T piece cover, for trunking type WDK 20050

PVC

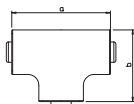
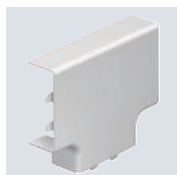

| Type | Colour | Dim. a mm | Dim. b mm | Pack Piece | Weight kg/100 pc. | Item no. |
|---------------|------------|-----------|-----------|------------|-------------------|----------|
| WDK HT20050RW | Pure white | 93 | 73 | 4 | 2.146 | 6154166 |
| WDK HT20050CW | Cream | 93 | 73 | 4 | 2.146 | 6152384 |

T piece cover for changing the direction of the WDK trunking.

End piece, trunking type WDK 20050

PVC

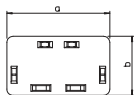
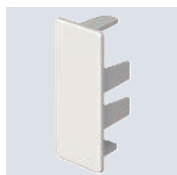

| Type | Colour | Dim. a mm | Dim. b mm | Pack Piece | Weight kg/100 pc. | Item no. |
|---------------|------------|-----------|-----------|------------|-------------------|----------|
| WDK HE20050RW | Pure white | 50 | 20 | 10 | 0.425 | 6154557 |
| WDK HE20050CW | Cream | 50 | 20 | 10 | 0.600 | 6153674 |

End piece to close the WDK trunking.

Trunking height 10 mm, trunking width 20 mm

Trunking, type WDK 10020

PVC

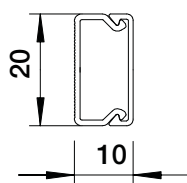

| Type | Colour | Length mm | Pack m | Weight kg/100 m | Item no. |
|------------|------------|-----------|--------|-----------------|----------|
| WDK10020RW | Pure white | 2000 | 2 | 10.000 | 6150764 |
| WDK10020CW | Cream | 2000 | 2 | 10.000 | 6150756 |
| WDK10020SW | Jet black | 2000 | 96 | 10.000 | 6027321 |

Trunking cover and base with base perforation.

PVC



Joint cover, trunking type WDK 10020

| Type | Colour | Dim. | | Pack Piece | Weight kg/100 pc. | Item no. |
|---------------|------------|------|------|------------|-------------------|----------|
| | | a mm | b mm | | | |
| WDK HS10020RW | Pure white | 22 | 14 | 10 | 0.090 | 6154026 |

Joint cover for smooth connection of trunking segments.

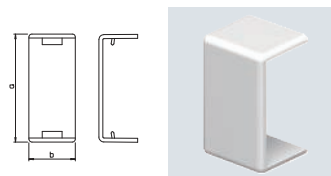

PVC



Internal corner cover, trunking type WDK 10020

| Type | Colour | Dim. | Pack Piece | Weight kg/100 pc. | Item no. |
|---------------|------------|------|------------|-------------------|----------|
| | | a mm | | | |
| WDK HI10020RW | Pure white | 30 | 4 | 0.285 | 6154328 |

Internal corner cover for changing the direction of the WDK trunking.

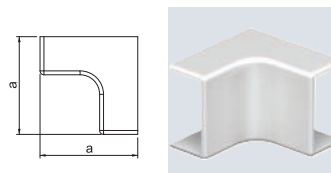

PVC



External corner cover, trunking type WDK 10020

| Type | Colour | Dim. | Pack Piece | Weight kg/100 pc. | Item no. |
|---------------|------------|------|------------|-------------------|----------|
| | | a mm | | | |
| WDK HA10020RW | Pure white | 30 | 4 | 0.344 | 6154417 |

External corner cover for changing the direction of the WDK trunking.

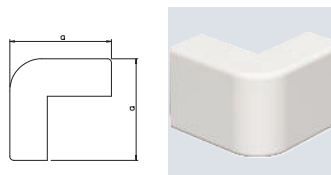

PVC



Flat angle cover, trunking type WDK 10020

| Type | Colour | Dim. | Pack Piece | Weight kg/100 pc. | Item no. |
|---------------|------------|------|------------|-------------------|----------|
| | | a mm | | | |
| WDK HF10020RW | Pure white | 40 | 4 | 0.365 | 6154212 |

Flat angle hood for changing the direction of the WDK trunking.

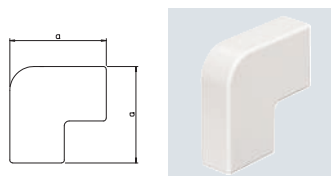

PVC



End piece, trunking type WDK 10020

| Type | Colour | Dim. | Pack Piece | Weight kg/100 pc. | Item no. |
|---------------|------------|------|------------|-------------------|----------|
| | | a mm | | | |
| WDK HE10020RW | Pure white | 22 | 10 | 0.106 | 6154514 |
| WDK HE10020CW | Cream | 22 | 10 | 0.106 | 6153593 |

End piece for closing the WDK trunking.

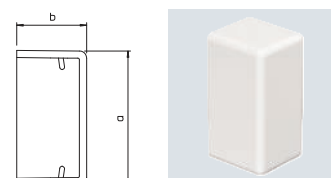

Trunking, type WDK 10020 with adhesive film

PVC

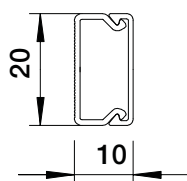

| Type | Colour | Length mm | Pack m | Weight kg/100 m | Item no. |
|-------------|------------|--------------|-----------|--------------------|----------|
| WDK10020SRW | Pure white | 2000 | 84 | 12.000 | 6027318 |
| WDK10020SSW | Jet black | 2000 | 84 | 12.000 | 6027374 |

Trunking cover and base with base perforation and adhesive film.

Joint cover, for trunking, type WDK 10020

PVC

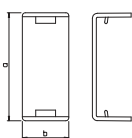

| Type | Colour | Dim. a mm | Dim. b mm | Pack Piece | Weight kg/100 pc. | Item no. |
|---------------|--------|-----------------|-----------------|---------------|----------------------|----------|
| WDK HS10020CW | Cream | 22 | 14 | 10 | 0.103 | 6152007 |

Joint cover for smooth connection of trunking segments.

Internal corner hood, for trunking type WDK 10020

PVC

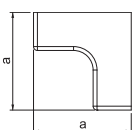
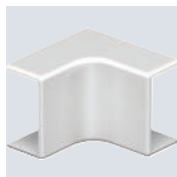

| Type | Colour | Dim. a mm | Pack Piece | Weight kg/100 pc. | Item no. |
|---------------|--------|-----------------|---------------|----------------------|----------|
| WDK HI10020CW | Cream | 30 | 4 | 0.285 | 6153003 |

Internal corner cover for changing the direction of the WDK trunking.

External corner cover, for trunking type WDK 10020

PVC

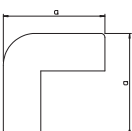

| Type | Colour | Dim. a mm | Pack Piece | Weight kg/100 pc. | Item no. |
|---------------|--------|-----------------|---------------|----------------------|----------|
| WDK HA10020CW | Cream | 30 | 4 | 0.600 | 6153291 |

External corner cover for changing the direction of the WDK trunking.

Flat angle hood, for trunking type WDK 10020

PVC

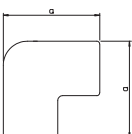

| Type | Colour | Dim. a mm | Pack Piece | Weight kg/100 pc. | Item no. |
|---------------|--------|-----------------|---------------|----------------------|----------|
| WDK HF10020CW | Cream | 40 | 4 | 0.365 | 6152600 |

Flat angle hood for changing the direction of the WDK trunking.

PVC



T piece cover, for trunking type WDK 10020

| Type | Colour | Dim. a mm | Pack Piece | Weight kg/100 pc. | Item no. |
|---------------|------------|-----------------|---------------|----------------------|----------|
| WDK HT10020RW | Pure white | 45 | 4 | 0.334 | 6154115 |
| WDK HT10020CW | Cream | 45 | 4 | 0.334 | 6152309 |

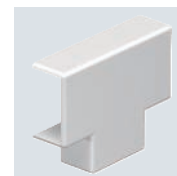
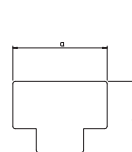

T piece hood for changing the direction of the WDK trunking.

Trunking, type WDK 25025

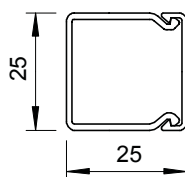
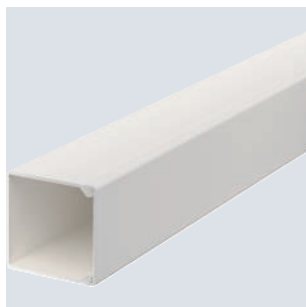

| Type | Colour | Length mm | Pack m | Weight kg/100 m | Item no. |
|-------------|------------|--------------|-----------|--------------------|----------|
| WDK25025RW | Pure white | 2000 | 30 | 24.500 | 6191053 |
| WDK25025CW | Cream | 2000 | 30 | 24.500 | 6026427 |
| WDK25025LGR | Light grey | 2000 | 30 | 24.500 | 6026400 |
| WDK25025GR | Stone grey | 2000 | 30 | 24.500 | 6026419 |
| WDK25025SRW | Pure white | 2000 | 30 | 37.710 | 6027372 |

Trunking cover and base with base perforation.

Internal corner cover, trunking type WDK 25025

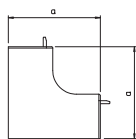
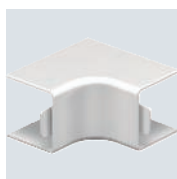

| Type | Colour | Dim. a mm | Pack Piece | Weight kg/100 pc. | Item no. |
|----------------|------------|-----------------|---------------|----------------------|----------|
| WDK HI25025RW | Pure white | 50 | 4 | 1.150 | 6191886 |
| WDK HI25025CW | Cream | 50 | 4 | 1.669 | 6160042 |
| WDK HI25025LGR | Light grey | 50 | 4 | 1.669 | 6182062 |
| WDK HI25025GR | Stone grey | 50 | 4 | 1.669 | 6158250 |

Internal corner cover for changing the direction of the WDK trunking.

External corner cover, for trunking type WDK 25025

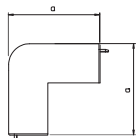
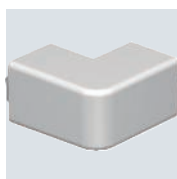

| Type | Colour | Dim. a mm | Pack Piece | Weight kg/100 pc. | Item no. |
|----------------|------------|-----------------|---------------|----------------------|----------|
| WDK HA25025RW | Pure white | 52 | 4 | 1.424 | 6192173 |
| WDK HA25025CW | Cream | 52 | 4 | 1.424 | 6160646 |
| WDK HA25025LGR | Light grey | 52 | 4 | 1.424 | 6182445 |
| WDK HA25025GR | Stone grey | 52 | 4 | 1.424 | 6158374 |

External corner hood for changing the direction of the WDK trunking.

Flat angle cover, trunking type WDK 25025

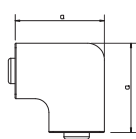
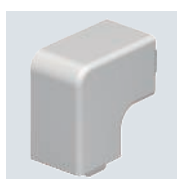

| Type | Colour | Dim. a mm | Pack Piece | Weight kg/100 pc. | Item no. |
|----------------|------------|-----------------|---------------|----------------------|----------|
| WDK HF25025RW | Pure white | 48 | 4 | 1.055 | 6192785 |
| WDK HF25025CW | Cream | 48 | 4 | 1.000 | 6161235 |
| WDK HF25025LGR | Light grey | 48 | 4 | 1.000 | 6183255 |
| WDK HF25025GR | Stone grey | 48 | 4 | 1.000 | 6158617 |

Flat angle cover for changing the direction of the WDK trunking.

PVC



T piece cover, for trunking type WDK 25025

| Type | Colour | Dim. a mm | Dim. b mm | Pack Piece | Weight kg/100 pc. | Item no. |
|----------------|------------|-----------------|-----------------|---------------|----------------------|----------|
| WDK HT25025RW | Pure white | 68 | 48 | 4 | 1.171 | 6192483 |
| WDK HT25025CW | Cream | 68 | 48 | 4 | 1.171 | 6161944 |
| WDK HT25025LGR | Light grey | 68 | 48 | 4 | 1.171 | 6182852 |
| WDK HT25025GR | Stone grey | 68 | 48 | 4 | 1.171 | 6158498 |

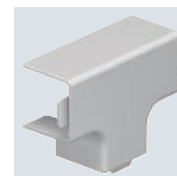
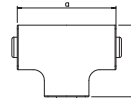

T piece cover for changing the direction of the WDK trunking.

PVC



End piece, trunking type WDK 25025

| Type | Colour | Dim. a mm | Dim. b mm | Pack Piece | Weight kg/100 pc. | Item no. |
|----------------|------------|-----------------|-----------------|---------------|----------------------|----------|
| WDK HE25025RW | Pure white | 25 | 25 | 10 | 0.303 | 6193145 |
| WDK HE25025CW | Cream | 25 | 25 | 10 | 0.303 | 6162533 |
| WDK HE25025LGR | Light grey | 25 | 25 | 10 | 0.303 | 6183662 |
| WDK HE25025GR | Stone grey | 25 | 25 | 10 | 0.303 | 6158730 |

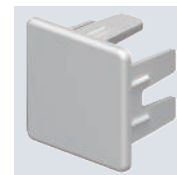
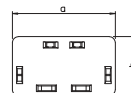

End piece to close the WDK trunking.

Trunking, type WDK 25040

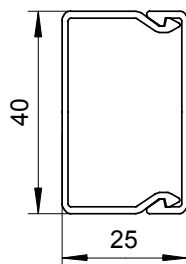

| Type | Colour | Length mm | Pack m | Weight kg/100 m | Item no. |
|-------------|------------|--------------|-----------|--------------------|----------|
| WDK25040RW | Pure white | 2000 | 24 | 30.000 | 6191061 |
| WDK25040CW | Cream | 2000 | 24 | 30.000 | 6026451 |
| WDK25040GR | Stone grey | 2000 | 24 | 30.000 | 6026443 |
| WDK25040LGR | Light grey | 2000 | 24 | 30.000 | 6026486 |
| WDK25040SW | Jet black | 2000 | 24 | 30.000 | 6026488 |

Trunking cover and base with base perforation.

Trunking, type WDK-N 25040

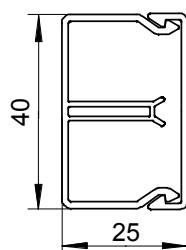
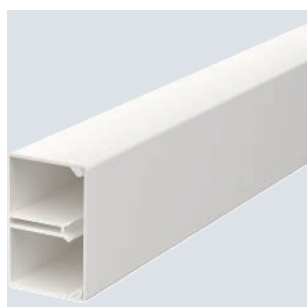

| Type | Colour | Length mm | Pack m | Weight kg/100 m | Item no. |
|--------------|------------|--------------|-----------|--------------------|----------|
| WDK-N25040RW | Pure white | 2000 | 2 | 36.000 | 6150640 |
| WDK-N25040CW | Cream | 2000 | 2 | 36.000 | 6150632 |

Trunking cover and base with base perforation.

Joint cover, for trunking, type WDK 25040

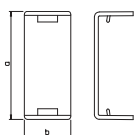

| Type | Colour | Dim. a mm | Dim. b mm | Pack Piece | Weight kg/100 pc. | Item no. |
|---------------|------------|-----------------|-----------------|---------------|----------------------|----------|
| WDK HS25040RW | Pure white | 42 | 14 | 10 | 0.231 | 6193560 |
| WDK HS25040CW | Cream | 42 | 14 | 10 | 0.231 | 6152082 |
| WDK HS25040GR | Stone grey | 42 | 14 | 10 | 0.231 | 6158889 |

Joint cover for smooth connection of trunking segments.

Internal corner cover, trunking type WDK 25040

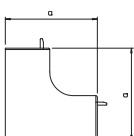
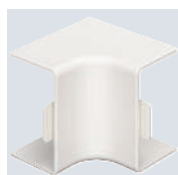

| Type | Colour | Dim. a mm | Pack Piece | Weight kg/100 pc. | Item no. |
|---------------|------------|-----------------|---------------|----------------------|----------|
| WDK HI25040RW | Pure white | 50 | 4 | 1.502 | 6191894 |
| WDK HI25040CW | Cream | 50 | 4 | 1.489 | 6160050 |
| WDK HI25040GR | Stone grey | 50 | 4 | 1.489 | 6158269 |

Internal corner cover for changing the direction of the WDK trunking.

PVC



External corner cover, for trunking type WDK 25040

| Type | Colour | Dim. a mm | Pack Piece | Weight kg/100 pc. | Item no. |
|---------------|------------|-----------------|---------------|----------------------|----------|
| WDK HA25040RW | Pure white | 52 | 4 | 2.052 | 6192181 |
| WDK HA25040CW | Cream | 52 | 4 | 2.052 | 6160654 |
| WDK HA25040GR | Stone grey | 52 | 4 | 2.052 | 6158382 |

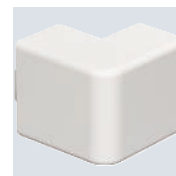
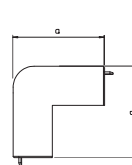

External corner hood for changing the direction of the WDK trunking.

PVC



Flat angle cover, trunking type WDK 25040

| Type | Colour | Dim. a mm | Pack Piece | Weight kg/100 pc. | Item no. |
|---------------|------------|-----------------|---------------|----------------------|----------|
| WDK HF25040RW | Pure white | 63 | 4 | 1.905 | 6192793 |
| WDK HF25040CW | Cream | 63 | 4 | 1.905 | 6161243 |
| WDK HF25040GR | Stone grey | 63 | 4 | 1.905 | 6158625 |

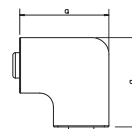

Flat angle hood for changing the direction of the WDK trunking.

PVC



T piece cover, for trunking type WDK 25040

| Type | Colour | Dim. a mm | Dim. b mm | Pack Piece | Weight kg/100 pc. | Item no. |
|---------------|------------|-----------------|-----------------|---------------|----------------------|----------|
| WDK HT25040RW | Pure white | 83 | 63 | 4 | 1.994 | 6192491 |
| WDK HT25040CW | Cream | 83 | 63 | 4 | 1.994 | 6161952 |
| WDK HT25040GR | Stone grey | 83 | 63 | 4 | 1.994 | 6158501 |

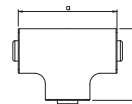

T piece cover for changing the direction of the WDK trunking.

PVC



End piece, trunking type WDK 25040

| Type | Colour | Dim. a mm | Dim. b mm | Pack Piece | Weight kg/100 pc. | Item no. |
|---------------|------------|-----------------|-----------------|---------------|----------------------|----------|
| WDK HE25040RW | Pure white | 40 | 25 | 10 | 0.404 | 6193153 |
| WDK HE25040CW | Cream | 40 | 25 | 10 | 0.404 | 6162541 |
| WDK HE25040GR | Stone grey | 40 | 25 | 10 | 0.404 | 6158749 |

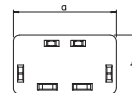

End piece to close the WDK trunking.

Trunking, type WDK 30030

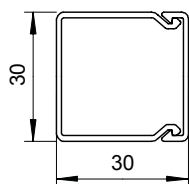

| Type | Colour | Length mm | Pack m | Weight kg/100 m | Item no. |
|-------------|-------------|--------------|-----------|--------------------|----------|
| WDK30030RW | Pure white | 2000 | 40 | 24.900 | 6191096 |
| WDK30030CW | Cream | 2000 | 40 | 24.900 | 6026826 |
| WDK30030LGR | Light grey | 2000 | 40 | 24.900 | 6026796 |
| WDK30030GR | Stone grey | 2000 | 40 | 24.900 | 6026818 |
| WDK30030BR | Sepia brown | 2000 | 40 | 24.900 | 6026834 |

Trunking cover and base with base perforation.

Internal corner cover, trunking type WDK 30030

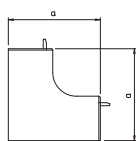
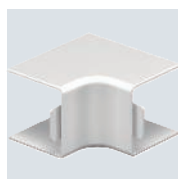

| Type | Colour | Dim. a mm | Pack Piece | Weight kg/100 pc. | Item no. |
|----------------|------------|-----------------|---------------|----------------------|----------|
| WDK HI30030RW | Pure white | 52 | 4 | 1.345 | 6191924 |
| WDK HI30030CW | Cream | 52 | 4 | 1.200 | 6160077 |
| WDK HI30030LGR | Light grey | 52 | 4 | 1.349 | 6182097 |
| WDK HI30030GR | Stone grey | 52 | 4 | 1.200 | 6158285 |

Internal corner cover for changing the direction of the WDK trunking.

External corner cover, trunking type WDK 30030

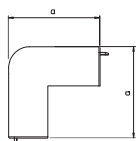
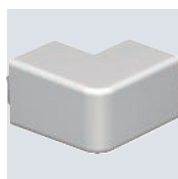

| Type | Colour | Dim. a mm | Pack Piece | Weight kg/100 pc. | Item no. |
|----------------|------------|-----------------|---------------|----------------------|----------|
| WDK HA30030RW | Pure white | 57 | 4 | 1.776 | 6192211 |
| WDK HA30030CW | Cream | 57 | 4 | 1.809 | 6160670 |
| WDK HA30030LGR | Light grey | 57 | 4 | 1.809 | 6182488 |
| WDK HA30030GR | Stone grey | 57 | 4 | 1.809 | 6158404 |

External corner hood for changing the direction of the WDK trunking.

Flat angle cover, trunking type WDK 30030

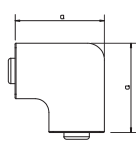

| Type | Colour | Dim. a mm | Pack Piece | Weight kg/100 pc. | Item no. |
|----------------|------------|-----------------|---------------|----------------------|----------|
| WDK HF30030RW | Pure white | 53 | 4 | 1.370 | 6192815 |
| WDK HF30030CW | Cream | 53 | 4 | 1.370 | 6161278 |
| WDK HF30030LGR | Light grey | 53 | 4 | 1.370 | 6183298 |
| WDK HF30030GR | Stone grey | 53 | 4 | 1.370 | 6158641 |

Flat angle hood for changing the direction of the WDK trunking.

PVC



T piece cover, for trunking type WDK 30030

| Type | Colour | Dim. a mm | Dim. b mm | Pack Piece | Weight kg/100 pc. | Item no. |
|----------------|------------|-----------------|-----------------|---------------|----------------------|----------|
| WDK HT30030RW | Pure white | 50 | 39 | 4 | 1.542 | 6192513 |
| WDK HT30030CW | Cream | 50 | 39 | 4 | 1.485 | 6161979 |
| WDK HT30030LGR | Light grey | 50 | 39 | 4 | 1.485 | 6182887 |
| WDK HT30030GR | Stone grey | 50 | 39 | 4 | 1.485 | 6158536 |

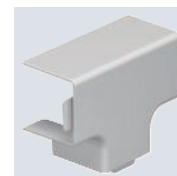
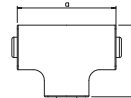

T piece hood for changing the direction of the WDK trunking.

PVC



End piece, trunking type WDK 30030

| Type | Colour | Dim. a mm | Dim. b mm | Pack Piece | Weight kg/100 pc. | Item no. |
|----------------|------------|-----------------|-----------------|---------------|----------------------|----------|
| WDK HE30030RW | Pure white | 30 | 30 | 10 | 0.363 | 6193188 |
| WDK HE30030CW | Cream | 30 | 30 | 10 | 0.365 | 6162576 |
| WDK HE30030LGR | Light grey | 30 | 30 | 10 | 0.365 | 6183697 |
| WDK HE30030GR | Stone grey | 30 | 30 | 10 | 0.365 | 6158765 |

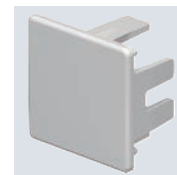
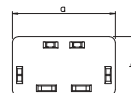

End piece to close the WDK trunking.

Trunking, type WDK 30045

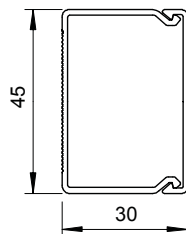
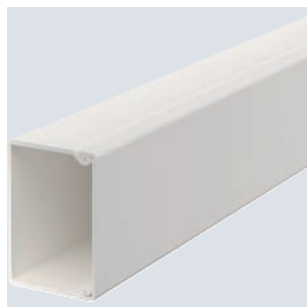

| Type | Colour | Length mm | Pack m | Weight kg/100 m | Item no. |
|-------------|------------|--------------|-----------|--------------------|----------|
| WDK30045RW | Pure white | 2000 | 48 | 32.000 | 6191118 |
| WDK30045CW | Cream | 2000 | 48 | 32.000 | 6026869 |
| WDK30045LGR | Light grey | 2000 | 48 | 32.000 | 6026842 |
| WDK30045GR | Stone grey | 2000 | 48 | 32.000 | 6026850 |

Trunking cover and base with base perforation.

Internal corner cover, trunking type WDK 30045

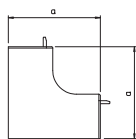
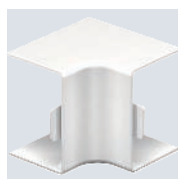

| Type | Colour | Dim. a mm | Pack Piece | Weight kg/100 pc. | Item no. |
|----------------|------------|-----------------|---------------|----------------------|----------|
| WDK HI30045RW | Pure white | 52 | 4 | 1.295 | 6191932 |
| WDK HI30045CW | Cream | 52 | 4 | 1.295 | 6160085 |
| WDK HI30045LGR | Light grey | 52 | 4 | 1.295 | 6182100 |
| WDK HI30045GR | Stone grey | 52 | 4 | 1.295 | 6158307 |

Internal corner cover for changing the direction of the WDK trunking.

External corner cover, trunking type WDK 30045

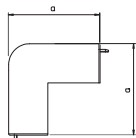
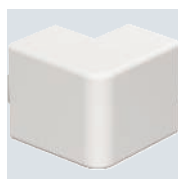

| Type | Colour | Dim. a mm | Pack Piece | Weight kg/100 pc. | Item no. |
|----------------|------------|-----------------|---------------|----------------------|----------|
| WDK HA30045RW | Pure white | 57 | 4 | 2.319 | 6192238 |
| WDK HA30045CW | Cream | 57 | 4 | 2.319 | 6160689 |
| WDK HA30045LGR | Light grey | 57 | 4 | 2.319 | 6182496 |
| WDK HA30045GR | Stone grey | 57 | 4 | 2.319 | 6158420 |

External corner hood for changing the direction of the WDK trunking.

Flat angle cover, trunking type WDK 30045

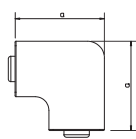

| Type | Colour | Dim. a mm | Pack Piece | Weight kg/100 pc. | Item no. |
|----------------|------------|-----------------|---------------|----------------------|----------|
| WDK HF30045RW | Pure white | 68 | 4 | 1.922 | 6192823 |
| WDK HF30045CW | Cream | 68 | 4 | 1.922 | 6161286 |
| WDK HF30045GR | Stone grey | 68 | 4 | 1.922 | 6158676 |
| WDK HF30045LGR | Light grey | 68 | 4 | 1.922 | 6183301 |

Flat angle hood for changing the direction of the WDK trunking.

PVC



T piece cover, for trunking type WDK 30045

| Type | Colour | Dim. a mm | Dim. b mm | Pack Piece | Weight kg/100 pc. | Item no. |
|----------------|------------|-----------------|-----------------|---------------|----------------------|----------|
| WDK HT30045RW | Pure white | 88 | 68 | 4 | 2.003 | 6192521 |
| WDK HT30045CW | Cream | 88 | 68 | 4 | 2.003 | 6161987 |
| WDK HT30045LGR | Light grey | 88 | 68 | 4 | 2.003 | 6182895 |
| WDK HT30045GR | Stone grey | 88 | 68 | 4 | 2.003 | 6158552 |

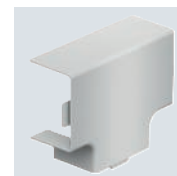
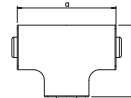

T-piece cover for changing the direction of the WDK trunking.

PVC



End piece, trunking type WDK 30045

| Type | Colour | Dim. a mm | Dim. b mm | Pack Piece | Weight kg/100 pc. | Item no. |
|----------------|------------|-----------------|-----------------|---------------|----------------------|----------|
| WDK HE30045RW | Pure white | 45 | 30 | 10 | 0.514 | 6193196 |
| WDK HE30045CW | Cream | 45 | 30 | 10 | 0.509 | 6162584 |
| WDK HE30045LGR | Light grey | 45 | 30 | 10 | 0.509 | 6183700 |
| WDK HE30045GR | Stone grey | 45 | 30 | 10 | 0.509 | 6158803 |

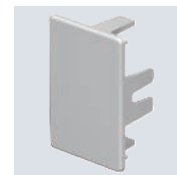
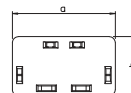

End piece to close the WDK trunking.

Trunking, type WDK 40040

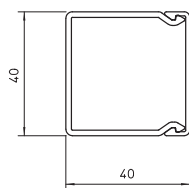

| Type | Colour | Length mm | Pack m | Weight kg/100 m | Item no. |
|-------------|-------------|--------------|-----------|--------------------|----------|
| WDK40040RW | Pure white | 2000 | 36 | 42.100 | 6191126 |
| WDK40040CW | Cream | 2000 | 36 | 42.100 | 6025412 |
| WDK40040LGR | Light grey | 2000 | 36 | 42.100 | 6027016 |
| WDK40040GR | Stone grey | 2000 | 36 | 42.100 | 6025447 |
| WDK40040BR | Sepia brown | 2000 | 36 | 42.100 | 6025420 |

Trunking cover and base with base perforation.

Internal corner cover, trunking type WDK 40040

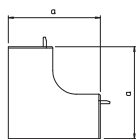
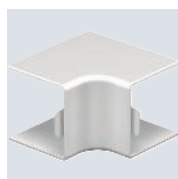

| Type | Colour | Dim. a mm | Pack Piece | Weight kg/100 pc. | Item no. |
|----------------|------------|-----------------|---------------|----------------------|----------|
| WDK HI40040RW | Pure white | 65 | 4 | 2.502 | 6191940 |
| WDK HI40040CW | Cream | 65 | 4 | 2.502 | 6160093 |
| WDK HI40040LGR | Light grey | 65 | 4 | 2.502 | 6182119 |
| WDK HI40040GR | Stone grey | 65 | 4 | 2.502 | 6158293 |

Internal corner cover for changing the direction of the WDK trunking.

External corner cover, trunking type WDK 40040

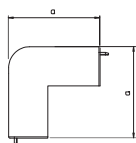

| Type | Colour | Dim. a mm | Pack Piece | Weight kg/100 pc. | Item no. |
|----------------|------------|-----------------|---------------|----------------------|----------|
| WDK HA40040RW | Pure white | 66 | 4 | 3.139 | 6192246 |
| WDK HA40040CW | Cream | 66 | 4 | 3.139 | 6160697 |
| WDK HA40040LGR | Light grey | 66 | 4 | 3.139 | 6182526 |
| WDK HA40040GR | Stone grey | 66 | 4 | 3.139 | 6158412 |

External corner hood for changing the direction of the WDK trunking.

Flat angle cover, trunking type WDK 40040

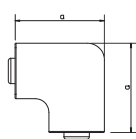

| Type | Colour | Dim. a mm | Pack Piece | Weight kg/100 pc. | Item no. |
|----------------|------------|-----------------|---------------|----------------------|----------|
| WDK HF40040RW | Pure white | 63 | 4 | 2.534 | 6192831 |
| WDK HF40040CW | Cream | 63 | 4 | 2.534 | 6161294 |
| WDK HF40040LGR | Light grey | 63 | 4 | 2.534 | 6183336 |
| WDK HF40040GR | Stone grey | 63 | 4 | 2.534 | 6158668 |

Flat angle cover for changing the direction of the WDK trunking.

PVC



T and intersection cover, for trunking type WDK 40040

| Type | Colour | Dim. a mm | Dim. b mm | Pack Piece | Weight kg/100 pc. | Item no. |
|----------------|------------|-----------|-----------|------------|-------------------|----------|
| WDK HT40040RW | Pure white | 83 | 43 | 4 | 2.681 | 6192548 |
| WDK HT40040CW | Cream | 83 | 43 | 4 | 2.681 | 6161995 |
| WDK HT40040LGR | Light grey | 83 | 43 | 4 | 2.681 | 6182917 |
| WDK HT40040GR | Stone grey | 83 | 43 | 4 | 2.681 | 6158544 |

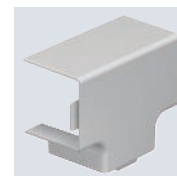
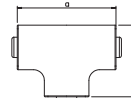

T and intersection cover for changing the direction of the WDK trunking. The fitting is preperforated at the side for the connection of different trunking cross-sections.

PVC



End piece, trunking type WDK 40040

| Type | Colour | Dim. a mm | Dim. b mm | Pack Piece | Weight kg/100 pc. | Item no. |
|----------------|------------|-----------|-----------|------------|-------------------|----------|
| WDK HE40040RW | Pure white | 40 | 40 | 10 | 0.602 | 6193218 |
| WDK HE40040CW | Cream | 40 | 40 | 10 | 0.615 | 6162592 |
| WDK HE40040LGR | Light grey | 40 | 40 | 10 | 0.602 | 6183727 |
| WDK HE40040GR | Stone grey | 40 | 40 | 10 | 0.602 | 6158773 |

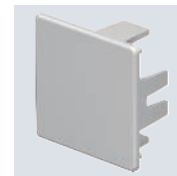
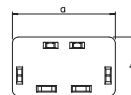

End piece to close the WDK trunking.

Trunking, type WDK 40060

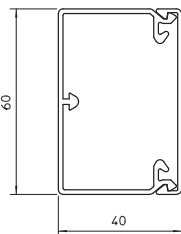

| Type | Colour | Length mm | Pack m | Weight kg/100 m | Item no. |
|-------------|-------------|--------------|-----------|--------------------|----------|
| WDK40060RW | Pure white | 2000 | 32 | 56.200 | 6191134 |
| WDK40060CW | Cream | 2000 | 32 | 56.200 | 6020887 |
| WDK40060LGR | Light grey | 2000 | 32 | 56.200 | 6027024 |
| WDK40060GR | Stone grey | 2000 | 32 | 56.200 | 6025633 |
| WDK40060BR | Sepia brown | 2000 | 32 | 56.200 | 6025617 |
| WDK40060SW | Jet black | 2000 | 32 | 56.200 | 6025638 |

Trunking cover and base with base perforation.

Internal corner cover, trunking type WDK 40060

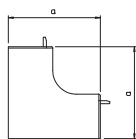
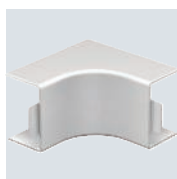

| Type | Colour | Dim. a mm | Pack Piece | Weight kg/100 pc. | Item no. |
|----------------|------------|-----------------|---------------|----------------------|----------|
| WDK HI40060RW | Pure white | 110 | 2 | 7.363 | 6191959 |
| WDK HI40060CW | Cream | 110 | 2 | 7.363 | 6160107 |
| WDK HI40060LGR | Light grey | 110 | 2 | 7.363 | 6182127 |
| WDK HI40060GR | Stone grey | 110 | 2 | 7.363 | 6021719 |

Internal corner cover for changing the direction of the WDK trunking.

External corner cover, trunking type WDK 40060

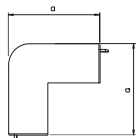
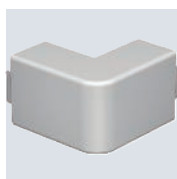

| Type | Colour | Dim. a mm | Pack Piece | Weight kg/100 pc. | Item no. |
|----------------|------------|-----------------|---------------|----------------------|----------|
| WDK HA40060RW | Pure white | 100 | 2 | 8.653 | 6192254 |
| WDK HA40060CW | Cream | 100 | 2 | 8.653 | 6160700 |
| WDK HA40060LGR | Light grey | 100 | 2 | 8.653 | 6182534 |
| WDK HA40060GR | Stone grey | 100 | 2 | 8.653 | 6021697 |

External corner hood for changing the direction of the WDK trunking.

Flat angle cover, trunking type WDK 40060

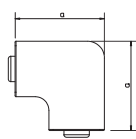

| Type | Colour | Dim. a mm | Pack Piece | Weight kg/100 pc. | Item no. |
|----------------|------------|-----------------|---------------|----------------------|----------|
| WDK HF40060RW | Pure white | 101 | 2 | 6.271 | 6192858 |
| WDK HF40060CW | Cream | 101 | 2 | 6.271 | 6161308 |
| WDK HF40060GR | Stone grey | 101 | 2 | 6.271 | 6021735 |
| WDK HF40060LGR | Light grey | 101 | 2 | 6.271 | 6183344 |

Flat angle hood for changing the direction of the WDK trunking.

PVC



T and intersection cover, for trunking type WDK 40060

| Type | Colour | Dim. a mm | Dim. b mm | Pack Piece | Weight kg/100 pc. | Item no. |
|----------------|------------|-----------|-----------|------------|-------------------|----------|
| WDK HK40060RW | Pure white | 190 | 63 | 2 | 9.801 | 6192556 |
| WDK HK40060CW | Cream | 190 | 63 | 2 | 9.801 | 6162002 |
| WDK HK40060LGR | Light grey | 190 | 63 | 2 | 9.801 | 6182925 |
| WDK HK40060GR | Stone grey | 190 | 63 | 2 | 9.801 | 6023312 |



T and intersection cover for changing the direction of the WDK trunking. The fitting is preperforated at the side for the connection of different trunking cross-sections.

PVC



End piece, trunking type WDK 40060

| Type | Colour | Dim. a mm | Dim. b mm | Pack Piece | Weight kg/100 pc. | Item no. |
|----------------|------------|-----------|-----------|------------|-------------------|----------|
| WDK HE40060RW | Pure white | 60 | 40 | 10 | 1.136 | 6193226 |
| WDK HE40060CW | Cream | 60 | 40 | 10 | 1.147 | 6162606 |
| WDK HE40060LGR | Light grey | 60 | 40 | 10 | 1.148 | 6183735 |
| WDK HE40060GR | Stone grey | 60 | 40 | 10 | 1.144 | 6021492 |

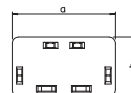

End piece to close the WDK trunking.

Trunking, type WDK 40090

PVC

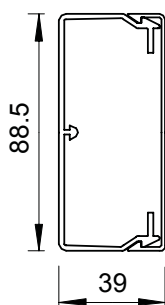

| Type | Colour | Length mm | Pack m | Weight kg/100 m | Item no. |
|-------------|------------|--------------|-----------|--------------------|----------|
| WDK40090RW | Pure white | 2000 | 32 | 77.300 | 6191142 |
| WDK40090CW | Cream | 2000 | 32 | 77.300 | 6020895 |
| WDK40090LGR | Light grey | 2000 | 32 | 77.300 | 6027032 |
| WDK40090GR | Stone grey | 2000 | 32 | 77.300 | 6021018 |
| WDK40090SW | Jet black | 2000 | 32 | 78.100 | 6021023 |

Trunking cover and base with base perforation.

Joint cover, for trunking, type WDK 40090

PVC

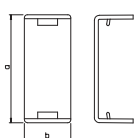

| Type | Colour | Dim. a mm | Dim. b mm | Pack Piece | Weight kg/100 pc. | Item no. |
|---------------|------------|-----------------|-----------------|---------------|----------------------|----------|
| WDK HS40090RW | Pure white | 90 | 39 | 20 | 0.857 | 6193580 |
| WDK HS40090CW | Cream | 90 | 39 | 20 | 0.857 | 6193582 |

Joint cover for hiding cut edges and for smooth connection of trunking segments.

Internal corner cover, trunking type WDK 40090

PVC

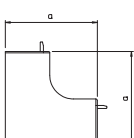
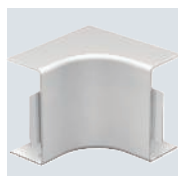

| Type | Colour | Dim. a mm | Pack Piece | Weight kg/100 pc. | Item no. |
|----------------|------------|-----------------|---------------|----------------------|----------|
| WDK HI40090RW | Pure white | 109 | 2 | 9.468 | 6191967 |
| WDK HI40090CW | Cream | 109 | 2 | 9.468 | 6160115 |
| WDK HI40090LGR | Light grey | 109 | 2 | 9.468 | 6182135 |
| WDK HI40090GR | Stone grey | 109 | 2 | 9.468 | 6021190 |

Internal corner cover for changing the direction of the WDK trunking.

External corner cover, trunking type WDK 40090

PVC

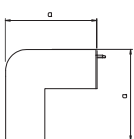

| Type | Colour | Dim. a mm | Pack Piece | Weight kg/100 pc. | Item no. |
|----------------|------------|-----------------|---------------|----------------------|----------|
| WDK HA40090RW | Pure white | 100 | 2 | 9.638 | 6192262 |
| WDK HA40090CW | Cream | 100 | 2 | 9.638 | 6160719 |
| WDK HA40090LGR | Light grey | 100 | 2 | 9.638 | 6182542 |
| WDK HA40090GR | Stone grey | 100 | 2 | 9.638 | 6021093 |

External corner hood for changing the direction of the WDK trunking.

PVC



Flat angle cover, trunking type WDK 40090

| Type | Colour | Dim. a mm | Pack Piece | Weight kg/100 pc. | Item no. |
|----------------|------------|-----------------|---------------|----------------------|----------|
| WDK HF40090RW | Pure white | 129 | 2 | 11.246 | 6192866 |
| WDK HF40090CW | Cream | 129 | 2 | 11.246 | 6161316 |
| WDK HF40090LGR | Light grey | 129 | 2 | 11.246 | 6183352 |
| WDK HF40090GR | Stone grey | 129 | 2 | 11.246 | 6021336 |

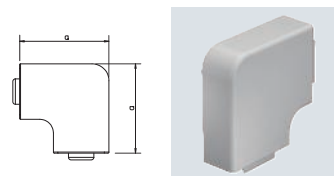

Flat angle hood for changing the direction of the WDK trunking.

PVC



T and intersection cover, for trunking type WDK 40090

| Type | Colour | Dim. a mm | Dim. b mm | Pack Piece | Weight kg/100 pc. | Item no. |
|----------------|------------|-----------------|-----------------|---------------|----------------------|----------|
| WDK HK40090RW | Pure white | 230 | 91 | 2 | 13.986 | 6192564 |
| WDK HK40090CW | Cream | 230 | 91 | 2 | 13.986 | 6162010 |
| WDK HK40090LGR | Light grey | 230 | 91 | 2 | 13.986 | 6182933 |
| WDK HK40090GR | Stone grey | 230 | 91 | 2 | 13.986 | 6023142 |

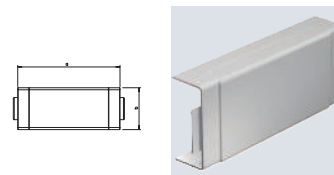

T and intersection cover for changing the direction of the WDK trunking. The fitting is preperforated at the side for the connection of different trunking cross-sections.

PVC



End piece, trunking type WDK 40090

| Type | Colour | Dim. a mm | Dim. b mm | Pack Piece | Weight kg/100 pc. | Item no. |
|----------------|------------|-----------------|-----------------|---------------|----------------------|----------|
| WDK HE40090RW | Pure white | 90 | 40 | 10 | 1.576 | 6193234 |
| WDK HE40090CW | Cream | 90 | 40 | 10 | 1.576 | 6162614 |
| WDK HE40090LGR | Light grey | 90 | 40 | 10 | 1.566 | 6183743 |
| WDK HE40090GR | Stone grey | 90 | 40 | 10 | 1.576 | 6021506 |

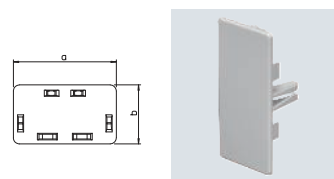

End piece to close the WDK trunking.

Trunking, type WDK 40110

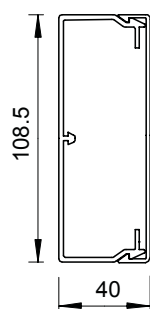

| Type | Colour | Length mm | Pack m | Weight kg/100 m | Item no. |
|-------------|------------|--------------|-----------|--------------------|----------|
| WDK40110RW | Pure white | 2000 | 24 | 111.800 | 6191150 |
| WDK40110CW | Cream | 2000 | 24 | 111.800 | 6020909 |
| WDK40110LGR | Light grey | 2000 | 24 | 111.800 | 6027040 |
| WDK40110GR | Stone grey | 2000 | 24 | 111.800 | 6021034 |

Trunking cover and base with base perforation.

Joint cover, for trunking, type WDK 40110

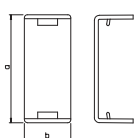

| Type | Colour | Dim. a mm | Dim. b mm | Pack Piece | Weight kg/100 pc. | Item no. |
|---------------|------------|-----------------|-----------------|---------------|----------------------|----------|
| WDK HS40110RW | Pure white | 110 | 39 | 20 | 0.974 | 6193586 |
| WDK HS40110CW | Cream | 110 | 39 | 20 | 0.974 | 6193588 |

Joint cover for hiding cut edges and for smooth connection of trunking segments.

Internal corner cover, trunking type WDK 40110

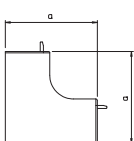
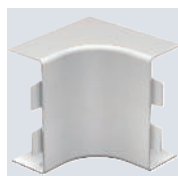

| Type | Colour | Dim. a mm | Pack Piece | Weight kg/100 pc. | Item no. |
|----------------|------------|-----------------|---------------|----------------------|----------|
| WDK HI40110RW | Pure white | 110.5 | 2 | 9.726 | 6191975 |
| WDK HI40110CW | Cream | 110.5 | 2 | 9.726 | 6160123 |
| WDK HI40110LGR | Light grey | 110.5 | 2 | 9.726 | 6182143 |
| WDK HI40110GR | Stone grey | 110.5 | 2 | 9.726 | 6021727 |

Internal corner cover for changing the direction of the WDK trunking.

External corner cover, trunking type WDK 40110

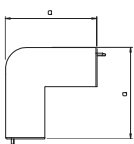
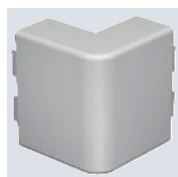

| Type | Colour | Dim. a mm | Pack Piece | Weight kg/100 pc. | Item no. |
|----------------|------------|-----------------|---------------|----------------------|----------|
| WDK HA40110RW | Pure white | 100 | 2 | 13.500 | 6192270 |
| WDK HA40110CW | Cream | 100 | 2 | 13.500 | 6160727 |
| WDK HA40110LGR | Light grey | 100 | 2 | 13.500 | 6182550 |
| WDK HA40110GR | Stone grey | 100 | 2 | 13.500 | 6021700 |

External corner hood for changing the direction of the WDK trunking.

PVC



Flat angle cover, trunking type WDK 40110

| Type | Colour | Dim. a mm | Pack Piece | Weight kg/100 pc. | Item no. |
|----------------|------------|-----------------|---------------|----------------------|----------|
| WDK HF40110RW | Pure white | 110 | 2 | 13.000 | 6192874 |
| WDK HF40110CW | Cream | 110 | 2 | 13.000 | 6161324 |
| WDK HF40110LGR | Light grey | 110 | 2 | 13.000 | 6183360 |
| WDK HF40110GR | Stone grey | 110 | 2 | 11.751 | 6021743 |

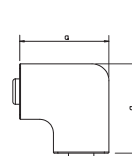

Flat angle hood for changing the direction of the WDK trunking.

PVC



T and intersection cover, for trunking type WDK 40110

| Type | Colour | Dim. a mm | Dim. b mm | Pack Piece | Weight kg/100 pc. | Item no. |
|----------------|------------|-----------------|-----------------|---------------|----------------------|----------|
| WDK HK40110RW | Pure white | 272 | 112 | 2 | 18.882 | 6192572 |
| WDK HK40110CW | Cream | 272 | 112 | 2 | 18.882 | 6162029 |
| WDK HK40110LGR | Light grey | 272 | 112 | 2 | 18.882 | 6182941 |
| WDK HK40110GR | Stone grey | 272 | 112 | 2 | 18.882 | 6023339 |



T and intersection cover for changing the direction of the WDK trunking. The fitting is preperforated at the side for the connection of different trunking cross-sections.

PVC



End piece, trunking type WDK 40110

| Type | Colour | Dim. a mm | Dim. b mm | Pack Piece | Weight kg/100 pc. | Item no. |
|----------------|------------|-----------------|-----------------|---------------|----------------------|----------|
| WDK HE40110RW | Pure white | 110 | 40 | 10 | 1.919 | 6193242 |
| WDK HE40110CW | Cream | 110 | 40 | 10 | 1.859 | 6162622 |
| WDK HE40110LGR | Light grey | 110 | 40 | 10 | 1.859 | 6183751 |
| WDK HE40110GR | Stone grey | 110 | 40 | 10 | 1.859 | 6021514 |

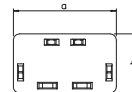

End piece to close the WDK trunking.

Trunking, type WDK 60060

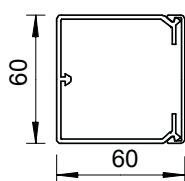

| Type | Colour | Length mm | Pack m | Weight kg/100 m | Item no. |
|-------------|------------|--------------|-----------|--------------------|----------|
| WDK60060RW | Pure white | 2000 | 32 | 81.600 | 6191193 |
| WDK60060CW | Cream | 2000 | 32 | 81.600 | 6021948 |
| WDK60060LGR | Light grey | 2000 | 32 | 81.600 | 6027105 |
| WDK60060GR | Stone grey | 2000 | 32 | 81.600 | 6025668 |

Trunking cover and base with base perforation.

Internal corner cover, trunking type WDK 60060

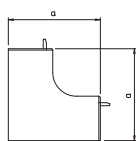
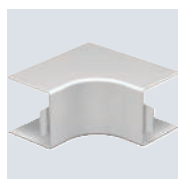

| Type | Colour | Dim. a mm | Pack Piece | Weight kg/100 pc. | Item no. |
|----------------|------------|-----------------|---------------|----------------------|----------|
| WDK HI60060RW | Pure white | 130 | 2 | 10.932 | 6192017 |
| WDK HI60060CW | Cream | 130 | 2 | 10.932 | 6160301 |
| WDK HI60060LGR | Light grey | 130 | 2 | 10.932 | 6182194 |
| WDK HI60060GR | Stone grey | 130 | 2 | 10.932 | 6022383 |

Internal corner cover for changing the direction of the WDK trunking.

External corner cover, trunking type WDK 60060

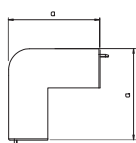

| Type | Colour | Dim. a mm | Pack Piece | Weight kg/100 pc. | Item no. |
|----------------|------------|-----------------|---------------|----------------------|----------|
| WDK HA60060RW | Pure white | 100 | 2 | 9.931 | 6192319 |
| WDK HA60060CW | Cream | 100 | 2 | 9.931 | 6160905 |
| WDK HA60060LGR | Light grey | 100 | 2 | 9.931 | 6182593 |
| WDK HA60060GR | Stone grey | 100 | 2 | 9.931 | 6022073 |

External corner hood for changing the direction of the WDK trunking.

Flat angle cover, trunking type WDK 60060

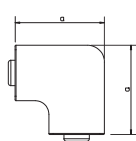

| Type | Colour | Dim. a mm | Pack Piece | Weight kg/100 pc. | Item no. |
|----------------|------------|-----------------|---------------|----------------------|----------|
| WDK HF60060RW | Pure white | 101 | 2 | 7.846 | 6192912 |
| WDK HF60060CW | Cream | 101 | 2 | 8.016 | 6161502 |
| WDK HF60060LGR | Light grey | 101 | 2 | 8.243 | 6183409 |
| WDK HF60060GR | Stone grey | 101 | 2 | 8.016 | 6022448 |

Flat angle hood for changing the direction of the WDK trunking.

PVC



T and intersection cover, for trunking type WDK 60060

| Type | Colour | Dim. a mm | Dim. b mm | Pack Piece | Weight kg/100 pc. | Item no. |
|----------------|------------|-----------|-----------|------------|-------------------|----------|
| WDK HK60060RW | Pure white | 190 | 65 | 2 | 12.876 | 6192610 |
| WDK HK60060CW | Cream | 190 | 65 | 2 | 12.876 | 6162207 |
| WDK HK60060LGR | Light grey | 190 | 65 | 2 | 12.876 | 6183018 |
| WDK HK60060GR | Stone grey | 190 | 65 | 2 | 12.876 | 6023223 |



T and intersection cover for changing the direction of the WDK trunking. The fitting is preperforated at the side for the connection of different trunking cross-sections.

PVC



End piece, trunking type WDK 60060

| Type | Colour | Dim. a mm | Dim. b mm | Pack Piece | Weight kg/100 pc. | Item no. |
|----------------|------------|-----------|-----------|------------|-------------------|----------|
| WDK HE60060RW | Pure white | 60 | 60 | 10 | 1.551 | 6193285 |
| WDK HE60060CW | Cream | 60 | 60 | 10 | 1.551 | 6162800 |
| WDK HE60060LGR | Light grey | 60 | 60 | 10 | 1.551 | 6183808 |
| WDK HE60060GR | Stone grey | 60 | 60 | 10 | 1.544 | 6022499 |

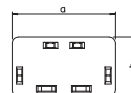

End piece to close the WDK trunking.

Trunking, type WDK 60090

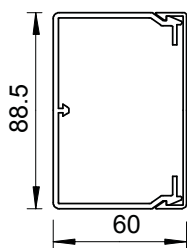

| Type | Colour | Length mm | Pack m | Weight kg/100 m | Item no. |
|-------------|------------|--------------|-----------|--------------------|----------|
| WDK60090RW | Pure white | 2000 | 24 | 110.000 | 6191207 |
| WDK60090CW | Cream | 2000 | 24 | 110.000 | 6021913 |
| WDK60090LGR | Light grey | 2000 | 24 | 110.000 | 6027113 |
| WDK60090GR | Stone grey | 2000 | 24 | 110.000 | 6022006 |

Trunking cover and base with base perforation.

Joint cover, for trunking, type WDK 60090

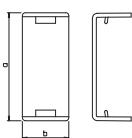

| Type | Colour | Dim. a mm | Dim. b mm | Pack Piece | Weight kg/100 pc. | Item no. |
|---------------|------------|-----------------|-----------------|---------------|----------------------|----------|
| WDK HS60090RW | Pure white | 94 | 18 | 20 | 1.002 | 6193590 |
| WDK HS60090CW | Cream | 94 | 18 | 20 | 1.008 | 6193592 |

Joint cover for hiding cut edges and for smooth connection of trunking segments.

Internal corner cover, trunking type WDK 60090

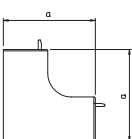
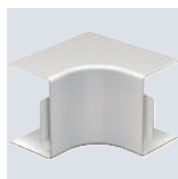

| Type | Colour | Dim. a mm | Pack Piece | Weight kg/100 pc. | Item no. |
|----------------|------------|-----------------|---------------|----------------------|----------|
| WDK HI60090RW | Pure white | 130 | 2 | 12.989 | 6192025 |
| WDK HI60090CW | Cream | 130 | 2 | 12.989 | 6160328 |
| WDK HI60090LGR | Light grey | 130 | 2 | 12.989 | 6182208 |
| WDK HI60090GR | Stone grey | 130 | 2 | 12.989 | 6022219 |

Internal corner cover for changing the direction of the WDK trunking.

External corner cover, trunking type WDK 60090

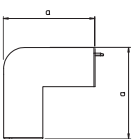
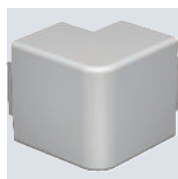

| Type | Colour | Dim. a mm | Pack Piece | Weight kg/100 pc. | Item no. |
|----------------|------------|-----------------|---------------|----------------------|----------|
| WDK HA60090RW | Pure white | 100 | 2 | 10.965 | 6192327 |
| WDK HA60090CW | Cream | 100 | 2 | 10.965 | 6160913 |
| WDK HA60090LGR | Light grey | 100 | 2 | 10.965 | 6182607 |
| WDK HA60090GR | Stone grey | 100 | 2 | 10.965 | 6022111 |

External corner hood for changing the direction of the WDK trunking.

PVC



Flat angle cover, trunking type WDK 60090

| Type | Colour | Dim. a mm | Pack Piece | Weight kg/100 pc. | Item no. |
|----------------|------------|-----------------|---------------|----------------------|----------|
| WDK HF60090RW | Pure white | 129 | 2 | 11.454 | 6192920 |
| WDK HF60090CW | Cream | 129 | 2 | 11.454 | 6161510 |
| WDK HF60090LGR | Light grey | 129 | 2 | 11.454 | 6183417 |
| WDK HF60090GR | Stone grey | 129 | 2 | 11.454 | 6022316 |

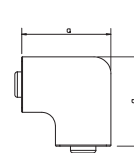

Flat angle hood for changing the direction of the WDK trunking.

PVC



T and intersection cover, for trunking type WDK 60090

| Type | Colour | Dim. a mm | Dim. b mm | Pack Piece | Weight kg/100 pc. | Item no. |
|----------------|------------|-----------------|-----------------|---------------|----------------------|----------|
| WDK HK60090RW | Pure white | 230 | 94 | 2 | 16.992 | 6192629 |
| WDK HK60090CW | Cream | 230 | 94 | 2 | 16.992 | 6162215 |
| WDK HK60090LGR | Light grey | 230 | 94 | 2 | 16.992 | 6183026 |
| WDK HK60090GR | Stone grey | 230 | 94 | 2 | 16.992 | 6023002 |

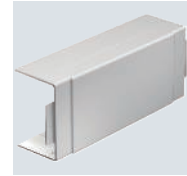
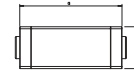

T and intersection cover for changing the direction of the WDK trunking. The fitting is preperforated at the side for the connection of different trunking cross-sections.

PVC



End piece, trunking type WDK 60090

| Type | Colour | Dim. a mm | Dim. b mm | Pack Piece | Weight kg/100 pc. | Item no. |
|----------------|------------|-----------------|-----------------|---------------|----------------------|----------|
| WDK HE60090RW | Pure white | 90 | 60 | 10 | 2.315 | 6193293 |
| WDK HE60090CW | Cream | 90 | 60 | 10 | 2.337 | 6162819 |
| WDK HE60090LGR | Light grey | 90 | 60 | 10 | 2.337 | 6183816 |
| WDK HE60090GR | Stone grey | 90 | 60 | 10 | 2.337 | 6022502 |

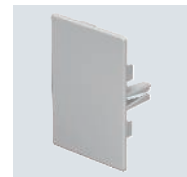
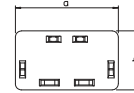

End piece to close the WDK trunking.

Trunking, type WDK 60110

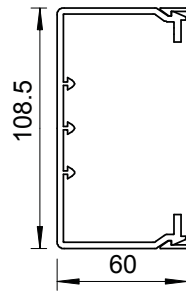

| Type | Colour | Length mm | Pack m | Weight kg/100 m | Item no. |
|-------------|------------|--------------|-----------|--------------------|----------|
| WDK60110RW | Pure white | 2000 | 16 | 117.000 | 6191215 |
| WDK60110CW | Cream | 2000 | 16 | 117.000 | 6021840 |
| WDK60110LGR | Light grey | 2000 | 16 | 117.000 | 6027121 |
| WDK60110GR | Stone grey | 2000 | 16 | 117.000 | 6022014 |

Trunking cover and base with base perforation.

Joint cover, for trunking, type WDK 60110

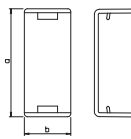

| Type | Colour | Dim. a mm | Dim. b mm | Pack Piece | Weight kg/100 pc. | Item no. |
|---------------|------------|-----------------|-----------------|---------------|----------------------|----------|
| WDK HS60110RW | Pure white | 113 | 18 | 20 | 1.142 | 6193596 |
| WDK HS60110CW | Cream | 113 | 18 | 20 | 1.142 | 6193598 |

Joint cover for hiding cut edges and for smooth connection of trunking segments.

Internal corner cover, trunking type WDK 60110

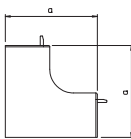
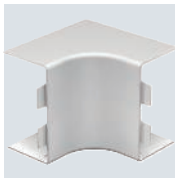

| Type | Colour | Dim. a mm | Pack Piece | Weight kg/100 pc. | Item no. |
|----------------|------------|-----------------|---------------|----------------------|----------|
| WDK HI60110RW | Pure white | 130 | 2 | 13.254 | 6192033 |
| WDK HI60110CW | Cream | 130 | 2 | 13.312 | 6160336 |
| WDK HI60110LGR | Light grey | 130 | 2 | 13.102 | 6182216 |
| WDK HI60110GR | Stone grey | 130 | 2 | 13.312 | 6022235 |

Internal corner cover for changing the direction of the WDK trunking.

External corner cover, trunking type WDK 60110

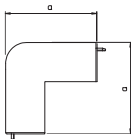
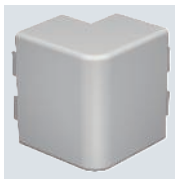

| Type | Colour | Dim. a mm | Pack Piece | Weight kg/100 pc. | Item no. |
|----------------|------------|-----------------|---------------|----------------------|----------|
| WDK HA60110RW | Pure white | 100 | 2 | 13.226 | 6192335 |
| WDK HA60110CW | Cream | 100 | 2 | 13.017 | 6160921 |
| WDK HA60110LGR | Light grey | 100 | 2 | 13.226 | 6182615 |
| WDK HA60110GR | Stone grey | 100 | 2 | 13.049 | 6022146 |

External corner hood for changing the direction of the WDK trunking.

PVC



Flat angle cover, trunking type WDK 60110

| Type | Colour | Dim. | | Pack Piece | Weight kg/100 pc. | Item no. |
|----------------|------------|------|------|------------|-------------------|----------|
| | | a mm | b mm | | | |
| WDK HF60110RW | Pure white | 149 | | 2 | 14.273 | 6192939 |
| WDK HF60110CW | Cream | 149 | | 2 | 14.399 | 6161529 |
| WDK HF60110LGR | Light grey | 149 | | 2 | 14.399 | 6183425 |
| WDK HF60110GR | Stone grey | 149 | | 2 | 14.399 | 6022332 |

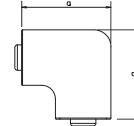

Flat angle hood for changing the direction of the WDK trunking.

PVC



T and intersection cover, for trunking type WDK 60110

| Type | Colour | Dim. | Dim. | Pack Piece | Weight kg/100 pc. | Item no. |
|----------------|------------|------|------|------------|-------------------|----------|
| | | a mm | b mm | | | |
| WDK HK60110RW | Pure white | 272 | 114 | 2 | 22.905 | 6192637 |
| WDK HK60110CW | Cream | 272 | 114 | 2 | 22.905 | 6162223 |
| WDK HK60110LGR | Light grey | 272 | 114 | 2 | 22.905 | 6183034 |
| WDK HK60110GR | Stone grey | 272 | 114 | 2 | 22.905 | 6023029 |

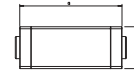

T and intersection cover for changing the direction of the WDK trunking. The fitting is preperforated at the side for the connection of different trunking cross-sections.

PVC



End piece, trunking type WDK 60110

| Type | Colour | Dim. | Dim. | Pack Piece | Weight kg/100 pc. | Item no. |
|----------------|------------|------|------|------------|-------------------|----------|
| | | a mm | b mm | | | |
| WDK HE60110RW | Pure white | 110 | 60 | 10 | 2.937 | 6193307 |
| WDK HE60110CW | Cream | 110 | 60 | 10 | 2.934 | 6162827 |
| WDK HE60110LGR | Light grey | 110 | 60 | 10 | 2.912 | 6183824 |
| WDK HE60110GR | Stone grey | 110 | 60 | 10 | 2.951 | 6022588 |

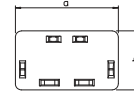

End piece for closing the WDK trunking.

Trunking, type WDK 60130

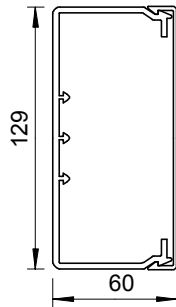

| Type | Colour | Length mm | Pack m | Weight kg/100 m | Item no. |
|-------------|------------|--------------|-----------|--------------------|----------|
| WDK60130RW | Pure white | 2000 | 16 | 135.000 | 6191223 |
| WDK60130CW | Cream | 2000 | 16 | 135.000 | 6021859 |
| WDK60130LGR | Light grey | 2000 | 16 | 135.000 | 6027148 |
| WDK60130GR | Stone grey | 2000 | 16 | 135.000 | 6022022 |

Trunking cover and base with base perforation.

Internal corner cover, trunking type WDK 60130

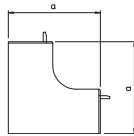
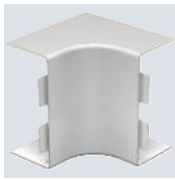

| Type | Colour | Dim. a mm | Pack Piece | Weight kg/100 pc. | Item no. |
|----------------|------------|-----------------|---------------|----------------------|----------|
| WDK HI60130RW | Pure white | 130 | 2 | 13.526 | 6192041 |
| WDK HI60130CW | Cream | 130 | 2 | 13.526 | 6160344 |
| WDK HI60130LGR | Light grey | 130 | 2 | 13.526 | 6182224 |
| WDK HI60130GR | Stone grey | 130 | 2 | 13.526 | 6022251 |

Internal corner cover for changing the direction of the WDK trunking.

External corner cover, trunking type WDK 60130

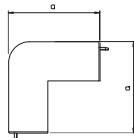

| Type | Colour | Dim. a mm | Pack Piece | Weight kg/100 pc. | Item no. |
|----------------|------------|-----------------|---------------|----------------------|----------|
| WDK HA60130RW | Pure white | 100 | 2 | 14.327 | 6192343 |
| WDK HA60130CW | Cream | 100 | 2 | 14.327 | 6160948 |
| WDK HA60130LGR | Light grey | 100 | 2 | 14.327 | 6182623 |
| WDK HA60130GR | Stone grey | 100 | 2 | 14.327 | 6022162 |

External corner hood for changing the direction of the WDK trunking.

Flat angle cover, trunking type WDK 60130

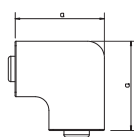

| Type | Colour | Dim. a mm | Pack Piece | Weight kg/100 pc. | Item no. |
|----------------|------------|-----------------|---------------|----------------------|----------|
| WDK HF60130RW | Pure white | 170 | 2 | 17.118 | 6192947 |
| WDK HF60130CW | Cream | 170 | 2 | 17.272 | 6161537 |
| WDK HF60130LGR | Light grey | 170 | 2 | 17.272 | 6183433 |
| WDK HF60130GR | Stone grey | 170 | 2 | 17.272 | 6022359 |

Flat angle hood for changing the direction of the WDK trunking.

PVC



T and intersection cover, for trunking type WDK 60130

| Type | Colour | Dim. a mm | Dim. b mm | Pack Piece | Weight kg/100 pc. | Item no. |
|----------------|------------|-----------|-----------|------------|-------------------|----------|
| WDK HK60130RW | Pure white | 272 | 65 | 2 | 23.968 | 6192645 |
| WDK HK60130CW | Cream | 272 | 65 | 2 | 23.968 | 6162231 |
| WDK HK60130LGR | Light grey | 272 | 65 | 2 | 23.968 | 6183042 |
| WDK HK60130GR | Stone grey | 272 | 65 | 2 | 23.968 | 6023045 |

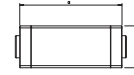

T and intersection cover for changing the direction of the WDK trunking. The fitting is preperforated at the side for the connection of different trunking cross-sections.

PVC



End piece, trunking type WDK 60130

| Type | Colour | Dim. a mm | Dim. b mm | Pack Piece | Weight kg/100 pc. | Item no. |
|----------------|------------|-----------|-----------|------------|-------------------|----------|
| WDK HE60130RW | Pure white | 130 | 61 | 10 | 3.610 | 6193315 |
| WDK HE60130CW | Cream | 130 | 61 | 10 | 3.596 | 6162835 |
| WDK HE60130LGR | Light grey | 130 | 61 | 10 | 3.655 | 6183832 |
| WDK HE60130GR | Stone grey | 130 | 61 | 10 | 3.578 | 6022529 |

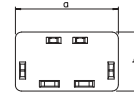

End piece to close the WDK trunking.

Trunking, type WDK 60150

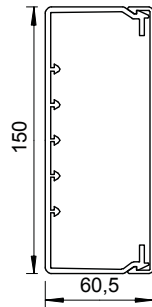

| Type | Colour | Length mm | Pack m | Weight kg/100 m | Item no. |
|-------------|------------|--------------|-----------|--------------------|----------|
| WDK60150RW | Pure white | 2000 | 8 | 175.000 | 6191231 |
| WDK60150CW | Cream | 2000 | 8 | 175.000 | 6021883 |
| WDK60150LGR | Light grey | 2000 | 8 | 175.000 | 6027156 |
| WDK60150GR | Stone grey | 2000 | 8 | 175.000 | 6022030 |

Trunking cover and base with base perforation.

Internal corner cover, trunking type WDK 60150

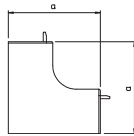

| Type | Colour | Dim. a mm | Pack Piece | Weight kg/100 pc. | Item no. |
|----------------|------------|-----------------|---------------|----------------------|----------|
| WDK HI60150RW | Pure white | 130 | 2 | 14.449 | 6192068 |
| WDK HI60150CW | Cream | 130 | 2 | 14.449 | 6160379 |
| WDK HI60150LGR | Light grey | 130 | 2 | 14.449 | 6182232 |
| WDK HI60150GR | Stone grey | 130 | 2 | 14.449 | 6024432 |

Internal corner cover for changing the direction of the WDK trunking.

External corner cover, trunking type WDK 60150

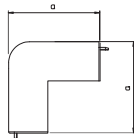

| Type | Colour | Dim. a mm | Pack Piece | Weight kg/100 pc. | Item no. |
|----------------|------------|-----------------|---------------|----------------------|----------|
| WDK HA60150RW | Pure white | 100 | 2 | 17.452 | 6192351 |
| WDK HA60150CW | Cream | 100 | 2 | 17.452 | 6160972 |
| WDK HA60150LGR | Light grey | 100 | 2 | 17.452 | 6182631 |
| WDK HA60150GR | Stone grey | 100 | 2 | 17.452 | 6024521 |

External corner hood for changing the direction of the WDK trunking.

Flat angle cover, trunking type WDK 60150

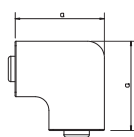

| Type | Colour | Dim. a mm | Pack Piece | Weight kg/100 pc. | Item no. |
|----------------|------------|-----------------|---------------|----------------------|----------|
| WDK HF60150RW | Pure white | 190 | 2 | 19.910 | 6192955 |
| WDK HF60150CW | Cream | 190 | 2 | 19.910 | 6161561 |
| WDK HF60150LGR | Light grey | 190 | 2 | 19.910 | 6183441 |
| WDK HF60150GR | Stone grey | 190 | 2 | 19.910 | 6024599 |

Flat angle hood for changing the direction of the WDK trunking.

PVC



T and intersection cover, for trunking type WDK 60150

| Type | Colour | Dim. a mm | Dim. b mm | Pack Piece | Weight kg/100 pc. | Item no. |
|----------------|------------|-----------|-----------|------------|-------------------|----------|
| WDK HK60150RW | Pure white | 291 | 155 | 2 | 26.831 | 6192653 |
| WDK HK60150CW | Cream | 291 | 155 | 2 | 26.831 | 6162274 |
| WDK HK60150LGR | Light grey | 291 | 155 | 2 | 26.831 | 6183050 |
| WDK HK60150GR | Stone grey | 291 | 155 | 2 | 26.831 | 6024769 |

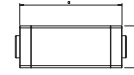

T and intersection cover for changing the direction of the WDK trunking. The fitting is preperforated at the side for the connection of different trunking cross-sections.

PVC



End piece, trunking type WDK 60150

| Type | Colour | Dim. a mm | Dim. b mm | Pack Piece | Weight kg/100 pc. | Item no. |
|----------------|------------|-----------|-----------|------------|-------------------|----------|
| WDK HE60150RW | Pure white | 150 | 60 | 10 | 4.118 | 6193323 |
| WDK HE60150CW | Cream | 150 | 60 | 10 | 4.223 | 6162878 |
| WDK HE60150LGR | Light grey | 150 | 60 | 10 | 4.827 | 6183840 |
| WDK HE60150GR | Stone grey | 150 | 60 | 10 | 4.223 | 6024823 |

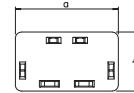

End piece to close the WDK trunking.

Trunking, type WDK 60170

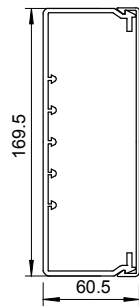

| Type | Colour | Length mm | Pack m | Weight kg/100 m | Item no. |
|-------------|------------|--------------|-----------|--------------------|----------|
| WDK60170RW | Pure white | 2000 | 8 | 178.000 | 6191258 |
| WDK60170CW | Cream | 2000 | 8 | 178.000 | 6021867 |
| WDK60170LGR | Light grey | 2000 | 8 | 178.000 | 6027164 |
| WDK60170GR | Stone grey | 2000 | 8 | 178.000 | 6022049 |

Trunking cover and base with base perforation.

Internal corner cover, trunking type WDK 60170

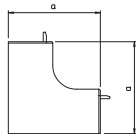
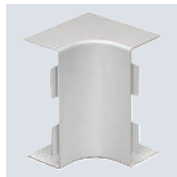

| Type | Colour | Dim. a mm | Pack Piece | Weight kg/100 pc. | Item no. |
|----------------|------------|-----------------|---------------|----------------------|----------|
| WDK HI60170RW | Pure white | 130 | 2 | 12.472 | 6192076 |
| WDK HI60170CW | Cream | 130 | 2 | 12.472 | 6160352 |
| WDK HI60170LGR | Light grey | 130 | 2 | 12.472 | 6182240 |
| WDK HI60170GR | Stone grey | 130 | 2 | 12.472 | 6022286 |

Internal corner cover for changing the direction of the WDK trunking.

External corner cover, trunking type WDK 60170

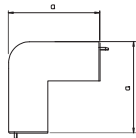

| Type | Colour | Dim. a mm | Pack Piece | Weight kg/100 pc. | Item no. |
|----------------|------------|-----------------|---------------|----------------------|----------|
| WDK HA60170RW | Pure white | 100 | 2 | 17.750 | 6192378 |
| WDK HA60170CW | Cream | 100 | 2 | 17.750 | 6160956 |
| WDK HA60170LGR | Light grey | 100 | 2 | 17.750 | 6182658 |
| WDK HA60170GR | Stone grey | 100 | 2 | 17.750 | 6022189 |

External corner hood for changing the direction of the WDK trunking.

Flat angle cover, trunking type WDK 60170

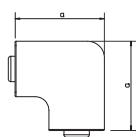

| Type | Colour | Dim. a mm | Pack Piece | Weight kg/100 pc. | Item no. |
|----------------|------------|-----------------|---------------|----------------------|----------|
| WDK HF60170RW | Pure white | 211 | 2 | 22.774 | 6192963 |
| WDK HF60170CW | Cream | 211 | 2 | 22.774 | 6161545 |
| WDK HF60170LGR | Light grey | 211 | 2 | 22.774 | 6183468 |
| WDK HF60170GR | Stone grey | 211 | 2 | 22.774 | 6022375 |

Flat angle hood for changing the direction of the WDK trunking.

PVC



T and intersection cover, for trunking type WDK 60170

| Type | Colour | Dim. a mm | Dim. b mm | Pack Piece | Weight kg/100 pc. | Item no. |
|----------------|------------|-----------|-----------|------------|-------------------|----------|
| WDK HK60170RW | Pure white | 291 | 66 | 2 | 32.600 | 6192661 |
| WDK HK60170CW | Cream | 291 | 66 | 2 | 32.600 | 6162258 |
| WDK HK60170LGR | Light grey | 291 | 66 | 2 | 32.600 | 6183069 |
| WDK HK60170GR | Stone grey | 291 | 66 | 2 | 32.600 | 6023061 |

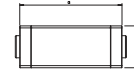

T and intersection cover for changing the direction of the WDK trunking. The fitting is preperforated at the side for the connection of different trunking cross-sections.

PVC



End piece, trunking type WDK 60170

| Type | Colour | Dim. a mm | Dim. b mm | Pack Piece | Weight kg/100 pc. | Item no. |
|----------------|------------|-----------|-----------|------------|-------------------|----------|
| WDK HE60170RW | Pure white | 170 | 60 | 10 | 4.859 | 6193331 |
| WDK HE60170CW | Cream | 170 | 60 | 10 | 4.859 | 6162843 |
| WDK HE60170LGR | Light grey | 170 | 60 | 10 | 4.859 | 6183859 |
| WDK HE60170GR | Stone grey | 170 | 60 | 10 | 4.859 | 6022545 |

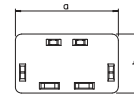

End piece to close the WDK trunking.

Trunking, type WDK 60210

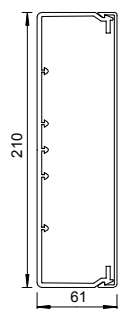

| Type | Colour | Length mm | Pack m | Weight kg/100 m | Item no. |
|-------------|------------|--------------|-----------|--------------------|----------|
| WDK60210RW | Pure white | 2000 | 8 | 258.000 | 6191266 |
| WDK60210CW | Cream | 2000 | 8 | 258.000 | 6021875 |
| WDK60210LGR | Light grey | 2000 | 8 | 258.000 | 6027172 |
| WDK60210GR | Stone grey | 2000 | 8 | 258.000 | 6022065 |

Trunking cover and base with base perforation.

Internal corner cover, trunking type WDK 60210

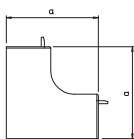

| Type | Colour | Dim. a mm | Pack Piece | Weight kg/100 pc. | Item no. |
|----------------|------------|-----------------|---------------|----------------------|----------|
| WDK HI60210RW | Pure white | 130 | 2 | 17.594 | 6192084 |
| WDK HI60210CW | Cream | 130 | 2 | 17.594 | 6160360 |
| WDK HI60210LGR | Light grey | 130 | 2 | 17.594 | 6182259 |
| WDK HI60210GR | Stone grey | 130 | 2 | 17.594 | 6022294 |

Internal corner cover for changing the direction of the WDK trunking.

External corner cover, trunking type WDK 60210

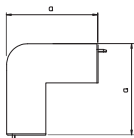

| Type | Colour | Dim. a mm | Pack Piece | Weight kg/100 pc. | Item no. |
|----------------|------------|-----------------|---------------|----------------------|----------|
| WDK HA60210RW | Pure white | 100 | 2 | 20.357 | 6192386 |
| WDK HA60210CW | Cream | 100 | 2 | 20.357 | 6160964 |
| WDK HA60210LGR | Light grey | 100 | 2 | 20.357 | 6182666 |
| WDK HA60210GR | Stone grey | 100 | 2 | 20.357 | 6022197 |

External corner hood for changing the direction of the WDK trunking.

Flat angle cover, trunking type WDK 60210

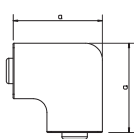

| Type | Colour | Dim. a mm | Pack Piece | Weight kg/100 pc. | Item no. |
|----------------|------------|-----------------|---------------|----------------------|----------|
| WDK HF60210RW | Pure white | 250 | 2 | 30.182 | 6192971 |
| WDK HF60210CW | Cream | 250 | 2 | 38.000 | 6161553 |
| WDK HF60210LGR | Light grey | 250 | 2 | 38.000 | 6183476 |
| WDK HF60210GR | Stone grey | 250 | 2 | 38.000 | 6022391 |

Flat angle hood for changing the direction of the WDK trunking.

PVC



T and intersection cover, for trunking type WDK 60210

| Type | Colour | Dim. a mm | Dim. b mm | Pack Piece | Weight kg/100 pc. | Item no. |
|----------------|------------|--------------|--------------|------------|----------------------|----------|
| WDK HK60210RW | Pure white | 291 | 66 | 2 | 35.280 | 6192688 |
| WDK HK60210CW | Cream | 291 | 66 | 2 | 35.280 | 6162266 |
| WDK HK60210LGR | Light grey | 291 | 66 | 2 | 35.280 | 6183077 |
| WDK HK60210GR | Stone grey | 291 | 66 | 2 | 35.280 | 6023126 |



T and intersection cover for changing the direction of the WDK trunking. The fitting is preperforated at the side for the connection of different trunking cross-sections.

PVC



End piece, trunking type WDK 60210

| Type | Colour | Dim. a mm | Dim. b mm | Pack Piece | Weight kg/100 pc. | Item no. |
|----------------|------------|--------------|--------------|------------|----------------------|----------|
| WDK HE60210RW | Pure white | 210 | 60 | 10 | 5.475 | 6193358 |
| WDK HE60210CW | Cream | 210 | 60 | 10 | 5.674 | 6162851 |
| WDK HE60210LGR | Light grey | 210 | 60 | 10 | 5.646 | 6183867 |
| WDK HE60210GR | Stone grey | 210 | 60 | 10 | 5.479 | 6022561 |

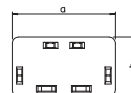

End piece to close the WDK trunking.

Trunking, type WDK 60230

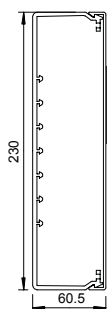

| Type | Colour | Length mm | Pack m | Weight kg/100 m | Item no. |
|-------------|------------|--------------|-----------|--------------------|----------|
| WDK60230RW | Pure white | 2000 | 8 | 298.000 | 6191274 |
| WDK60230CW | Cream | 2000 | 8 | 298.000 | 6021891 |
| WDK60230LGR | Light grey | 2000 | 8 | 298.000 | 6027180 |
| WDK60230GR | Stone grey | 2000 | 8 | 298.000 | 6022057 |

Trunking cover and base with base perforation.
Four cover fixing devices included.

Internal corner cover, trunking type WDK 60230

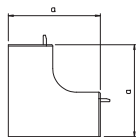

| Type | Colour | Dim. a mm | Pack Piece | Weight kg/100 pc. | Item no. |
|----------------|------------|-----------------|---------------|----------------------|----------|
| WDK HI60230RW | Pure white | 130 | 2 | 22.509 | 6192092 |
| WDK HI60230CW | Cream | 130 | 2 | 22.509 | 6160395 |
| WDK HI60230LGR | Light grey | 130 | 2 | 22.509 | 6182267 |
| WDK HI60230GR | Stone grey | 130 | 2 | 22.509 | 6024440 |

Internal corner cover for changing the direction of the WDK trunking.

External corner cover, trunking type WDK 60230

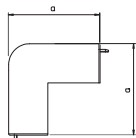

| Type | Colour | Dim. a mm | Pack Piece | Weight kg/100 pc. | Item no. |
|----------------|------------|-----------------|---------------|----------------------|----------|
| WDK HA60230RW | Pure white | 100 | 2 | 24.645 | 6192394 |
| WDK HA60230CW | Cream | 100 | 2 | 24.645 | 6160980 |
| WDK HA60230LGR | Light grey | 100 | 2 | 24.645 | 6182674 |
| WDK HA60230GR | Stone grey | 100 | 2 | 24.645 | 6024548 |

External corner hood for changing the direction of the WDK trunking.

T and intersection cover, for trunking type WDK 60210

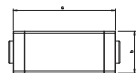

| Type | Colour | Dim. a mm | Dim. b mm | Pack Piece | Weight kg/100 pc. | Item no. |
|----------------|------------|-----------------|-----------------|---------------|----------------------|----------|
| WDK HK60230RW | Pure white | 291 | 235 | 2 | 39.600 | 6192696 |
| WDK HK60230CW | Cream | 291 | 235 | 2 | 39.600 | 6162290 |
| WDK HK60230LGR | Light grey | 291 | 235 | 2 | 39.600 | 6183085 |
| WDK HK60230GR | Stone grey | 291 | 235 | 2 | 39.600 | 6024777 |

T and intersection cover for changing the direction of the WDK trunking. The fitting is preperforated at the side for the connection of different trunking cross-sections.

PVC



Flat angle cover, trunking type WDK 60230

| Type | Colour | Dim. a mm | Pack Piece | Weight kg/100 pc. | Item no. |
|----------------|------------|-----------|------------|-------------------|----------|
| WDK HF60230RW | Pure white | 270 | 2 | 47.856 | 6192998 |
| WDK HF60230CW | Cream | 270 | 2 | 47.856 | 6161596 |
| WDK HF60230LGR | Light grey | 270 | 2 | 47.856 | 6183484 |
| WDK HF60230GR | Stone grey | 270 | 2 | 47.856 | 6024602 |

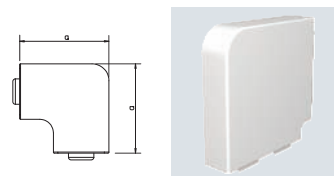

Flat angle hood for changing the direction of the WDK trunking.

PVC



End piece, trunking type WDK 60230

| Type | Colour | Dim. a mm | Dim. b mm | Pack Piece | Weight kg/100 pc. | Item no. |
|----------------|------------|-----------|-----------|------------|-------------------|----------|
| WDK HE60230RW | Pure white | 230 | 60 | 10 | 6.283 | 6193366 |
| WDK HE60230CW | Cream | 230 | 60 | 10 | 6.283 | 6162886 |
| WDK HE60230LGR | Light grey | 230 | 60 | 10 | 6.283 | 6183875 |
| WDK HE60230GR | Stone grey | 230 | 60 | 10 | 6.283 | 6024831 |

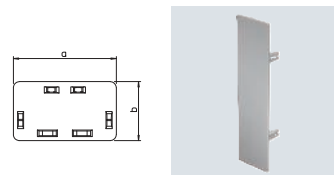

End piece to close the WDK trunking.

The end pieces are pushed onto the trunking and kept in place by the spring action.

Trunking, type WDK 80170

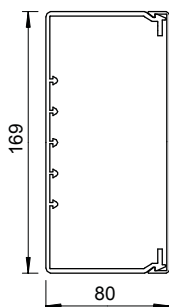

| Type | Colour | Length mm | Pack m | Weight kg/100 m | Item no. |
|-------------|------------|--------------|-----------|--------------------|----------|
| WDK80170RW | Pure white | 2000 | 8 | 214.000 | 6191304 |
| WDK80170CW | Cream | 2000 | 8 | 214.000 | 6026176 |
| WDK80170LGR | Light grey | 2000 | 8 | 214.000 | 6027229 |
| WDK80170GR | Stone grey | 2000 | 8 | 214.000 | 6026184 |

Wall installation trunking as trunking base with base perforation and matching trunking cover.

End piece, trunking type WDK 80170

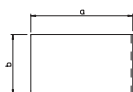
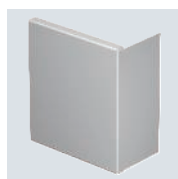

| Type | Colour | Dim. a mm | Dim. b mm | Pack Piece | Weight kg/100 pc. | Item no. |
|----------------|------------|-----------------|-----------------|---------------|----------------------|----------|
| WDK HE80170RW | Pure white | 150 | 170 | 10 | 11.900 | 6193387 |
| WDK HE80170CW | Cream | 150 | 170 | 10 | 11.900 | 6163009 |
| WDK HE80170LGR | Light grey | 150 | 170 | 10 | 11.900 | 6183913 |
| WDK HE80170GR | Stone grey | 150 | 170 | 10 | 11.900 | 6024858 |

End piece to close the WDK trunking.

T piece, for trunking type WDK 80170

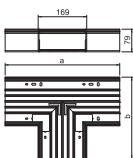

| Type | Colour | Dim. a mm | Pack Piece | Weight kg/100 pc. | Item no. |
|--------------|------------|-----------------|---------------|----------------------|----------|
| WDK T80170RW | Pure white | 400 | 2 | 120.000 | 6183994 |

T piece to change the direction of the WDK trunking.

External corner, trunking type WDK 80170

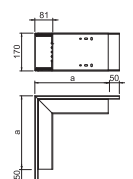

| Type | Colour | Dim. a mm | Pack Piece | Weight kg/100 pc. | Item no. |
|---------------|------------|-----------------|---------------|----------------------|----------|
| WDK A80170GR | Stone grey | 331 | 1 | 130.000 | 6024689 |
| WDK A80170CW | Cream | 331 | 1 | 130.000 | 6024654 |
| WDK A80170LGR | Light grey | 331 | 1 | 130.000 | 6160485 |
| WDK A80170RW | Pure white | 331 | 1 | 130.000 | 6160493 |
| WDK A80210GR | Stone grey | 329 | 1 | 160.000 | 6161104 |
| WDK A80210CW | Cream | 329 | 1 | 160.000 | 6160550 |
| WDK A80210LGR | Light grey | 329 | 1 | 160.000 | 6161112 |
| WDK A80210RW | Pure white | 329 | 1 | 160.000 | 6161155 |

External corner hood for changing the direction of the WDK trunking.

PVC



T piece, for trunking type WDK 80170

| Type | Colour | Dim. a mm | Pack Piece | Weight kg/100 pc. | Item no. |
|---------------|------------|-----------|------------|-------------------|----------|
| WDK T80170GR | Stone grey | 400 | 2 | 120.000 | 6193414 |
| WDK T80170CW | Cream | 400 | 2 | 120.000 | 6193404 |
| WDK T80170LGR | Light grey | 400 | 2 | 120.000 | 6163094 |
| WDK T80210GR | Stone grey | 400 | 2 | 130.000 | 6193415 |
| WDK T80210CW | Cream | 400 | 2 | 130.000 | 6193406 |
| WDK T80210LGR | Light grey | 400 | 2 | 130.000 | 6163096 |

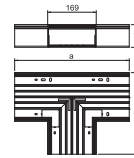

T piece to change the direction of the WDK trunking.

PVC



Flat angle, trunking type WDK 80170

| Type | Colour | Dim. a mm | Pack Piece | Weight kg/100 pc. | Item no. |
|---------------|------------|-----------|------------|-------------------|----------|
| WDK F80170GR | Stone grey | 470 | 1 | 170.000 | 6182764 |
| WDK F80170CW | Cream | 470 | 1 | 170.000 | 6182748 |
| WDK F80170LGR | Light grey | 470 | 1 | 170.000 | 6183523 |
| WDK F80170RW | Pure white | 470 | 1 | 170.000 | 6183531 |
| WDK F80210CW | Cream | 560.5 | 1 | 220.000 | 6183574 |

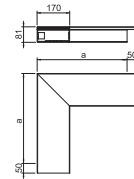

Flat angle for changing the direction of the WDK trunking.

PVC



Internal corner cover, trunking type WDK 80170

| Type | Colour | Dim. a mm | Pack Piece | Weight kg/100 pc. | Item no. |
|---------------|------------|-----------|------------|-------------------|----------|
| WDK I80170GR | Stone grey | 329 | 1 | 100.000 | 6193080 |
| WDK I80170CW | Cream | 329 | 1 | 100.000 | 6193078 |
| WDK I80170LGR | Light grey | 329 | 1 | 100.000 | 6193825 |
| WDK I80170RW | Pure white | 329 | 1 | 100.000 | 6193827 |

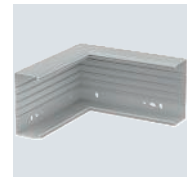
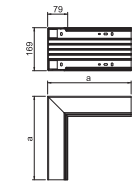

Internal corner cover for changing the direction of the WDK trunking.

Trunking height 80 mm, trunking width 210 mm

Trunking, type WDK 80210

PVC

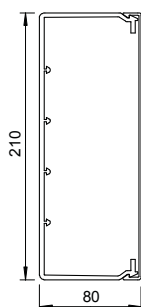

| Type | Colour | Length mm | Pack m | Weight kg/100 m | Item no. |
|-------------|------------|--------------|-----------|--------------------|----------|
| WDK80210RW | Pure white | 2000 | 8 | 240.000 | 6191312 |
| WDK80210CW | Cream | 2000 | 8 | 240.000 | 6026206 |
| WDK80210LGR | Light grey | 2000 | 8 | 240.000 | 6027237 |
| WDK80210GR | Stone grey | 2000 | 8 | 240.000 | 6026192 |

Wall installation trunking as trunking base with base perforation and matching trunking cover.

Four cover fixing devices included.

End piece, trunking type WDK 80210

PVC

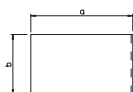

| Type | Colour | Dim. a mm | Dim. b mm | Pack Piece | Weight kg/100 pc. | Item no. |
|----------------|------------|-----------------|-----------------|---------------|----------------------|----------|
| WDK HE80210RW | Pure white | 150 | 80 | 10 | 14.500 | 6193391 |
| WDK HE80210CW | Cream | 150 | 210 | 10 | 14.500 | 6163017 |
| WDK HE80210LGR | Light grey | 150 | 210 | 10 | 14.500 | 6183921 |
| WDK HE80210GR | Stone grey | 150 | 210 | 10 | 14.500 | 6024874 |

End piece to close the WDK trunking.

Flat angle, trunking type WDK 80210

PVC

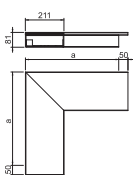

| Type | Colour | Dim. a mm | Pack Piece | Weight kg/100 pc. | Item no. |
|---------------|------------|-----------------|---------------|----------------------|----------|
| WDK F80210GR | Stone grey | 560.5 | 1 | 220.000 | 6192107 |
| WDK F80210LGR | Light grey | 560.5 | 1 | 220.000 | 6192111 |
| WDK F80210RW | Pure white | 560.5 | 1 | 220.000 | 6192115 |

Flat angle for changing the direction of the WDK trunking.

T piece, for trunking type WDK 80210

PVC

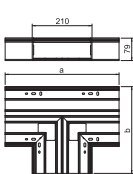

| Type | Colour | Dim. a mm | Pack Piece | Weight kg/100 pc. | Item no. |
|--------------|------------|-----------------|---------------|----------------------|----------|
| WDK T80210RW | Pure white | 400 | 2 | 130.000 | 6183996 |

T piece to change the direction of the WDK trunking.

Internal corner cover, trunking type WDK 80210

PVC

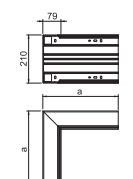
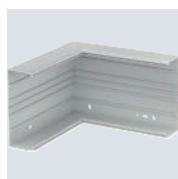

| Type | Colour | Dim. a mm | Pack Piece | Weight kg/100 pc. | Item no. |
|---------------|------------|-----------------|---------------|----------------------|----------|
| WDK I80210GR | Stone grey | 329 | 1 | 120.000 | 6193860 |
| WDK I80210CW | Cream | 329 | 1 | 120.000 | 6193831 |
| WDK I80210LGR | Light grey | 329 | 1 | 120.000 | 6193864 |
| WDK I80210RW | Pure white | 329 | 1 | 120.000 | 6193866 |

Internal corner cover for changing the direction of the WDK trunking.



Trunking, type WDK 100130

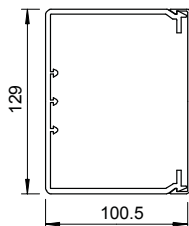

| Type | Colour | Length mm | Pack m | Weight kg/100 m | Item no. |
|--------------|------------|--------------|-----------|--------------------|----------|
| WDK100130RW | Pure white | 2000 | 8 | 214.000 | 6191347 |
| WDK100130CW | Cream | 2000 | 8 | 214.000 | 6026273 |
| WDK100130LGR | Light grey | 2000 | 8 | 214.000 | 6027245 |
| WDK100130GR | Stone grey | 2000 | 8 | 214.000 | 6026281 |

Wall installation trunking as trunking base with base perforation and matching trunking cover.

Four cover fixing devices included.

T piece, for trunking type WDK 100130

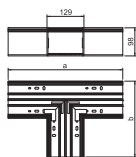

| Type | Colour | Dim. a mm | Pack Piece | Weight kg/100 pc. | Item no. |
|---------------|------------|-----------------|---------------|----------------------|----------|
| WDK T100130RW | Pure white | 400 | 1 | 120.000 | 6183990 |

T piece to change the direction of the WDK trunking.

End piece, trunking type WDK 100130

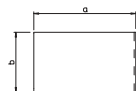

| Type | Colour | Dim. a mm | Dim. b mm | Pack Piece | Weight kg/100 pc. | Item no. |
|-----------------|------------|-----------------|-----------------|---------------|----------------------|----------|
| WDK HE100130RW | Pure white | 150 | 130 | 10 | 8.200 | 6193395 |
| WDK HE100130CW | Cream | 150 | 130 | 10 | 8.200 | 6163041 |
| WDK HE100130LGR | Light grey | 150 | 130 | 10 | 8.200 | 6183956 |
| WDK HE100130GR | Stone grey | 150 | 130 | 10 | 8.200 | 6024882 |

End piece to close the WDK trunking.

External corner, trunking type WDK 100130

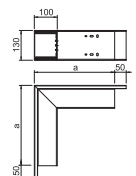
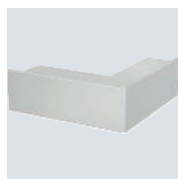

| Type | Colour | Dim. a mm | Pack Piece | Weight kg/100 pc. | Item no. |
|----------------|------------|-----------------|---------------|----------------------|----------|
| WDK A100130GR | Stone grey | 348 | 1 | 136.100 | 6024476 |
| WDK A100130CW | Cream | 348 | 1 | 136.100 | 6024468 |
| WDK A100130LGR | Light grey | 348 | 1 | 136.100 | 6024484 |
| WDK A100130RW | Pure white | 348 | 1 | 136.100 | 6024506 |
| WDK A100230GR | Stone grey | 348 | 1 | 193.200 | 6024581 |
| WDK A100230CW | Cream | 348 | 1 | 193.200 | 6024573 |
| WDK A100230LGR | Light grey | 348 | 1 | 193.200 | 6024611 |
| WDK A100230RW | Pure white | 348 | 1 | 193.200 | 6024630 |

External corner hood for changing the direction of the WDK trunking.

PVC



T piece, for trunking type WDK 100130

| Type | Colour | Dim. a mm | Pack Piece | Weight kg/100 pc. | Item no. |
|----------------|------------|-----------------|---------------|----------------------|----------|
| WDK T100130GR | Stone grey | 400 | 1 | 120.000 | 6193410 |
| WDK T100130CW | Cream | 400 | 1 | 120.000 | 6193400 |
| WDK T100130LGR | Light grey | 400 | 1 | 120.000 | 6163090 |
| WDK T100230GR | Stone grey | 600 | 1 | 248.800 | 6193412 |
| WDK T100230CW | Cream | 600 | 1 | 248.800 | 6193402 |
| WDK T100230LGR | Light grey | 600 | 1 | 248.800 | 6163092 |

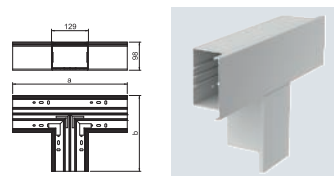

T piece to change the direction of the WDK trunking.

PVC



Flat angle, trunking type WDK 100130

| Type | Colour | Dim. a mm | Pack Piece | Weight kg/100 pc. | Item no. |
|----------------|------------|-----------------|---------------|----------------------|----------|
| WDK F100130GR | Stone grey | 300 | 1 | 109.900 | 6161716 |
| WDK F100130CW | Cream | 300 | 1 | 109.900 | 6161708 |
| WDK F100130LGR | Light grey | 300 | 1 | 109.900 | 6161759 |
| WDK F100130RW | Pure white | 300 | 1 | 109.900 | 6161775 |
| WDK F100230GR | Stone grey | 400 | 1 | 188.500 | 6182349 |
| WDK F100230CW | Cream | 400 | 1 | 188.500 | 6182314 |
| WDK F100230LGR | Light grey | 400 | 1 | 188.500 | 6182365 |
| WDK F100230RW | Pure white | 400 | 1 | 188.500 | 6182713 |

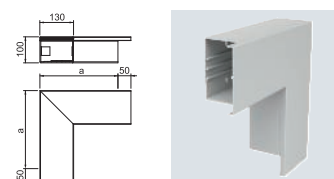

Flat angle for changing the direction of the WDK trunking.

PVC



Internal corner cover, trunking type WDK 100130

| Type | Colour | Dim. a mm | Pack Piece | Weight kg/100 pc. | Item no. |
|----------------|------------|-----------------|---------------|----------------------|----------|
| WDK I100130GR | Stone grey | 250 | 2 | 79.300 | 6192421 |
| WDK I100130CW | Cream | 250 | 2 | 79.300 | 6192417 |
| WDK I100130LGR | Light grey | 250 | 2 | 79.300 | 6192425 |
| WDK I100130RW | Pure white | 250 | 2 | 79.300 | 6192429 |

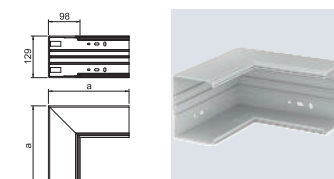

Internal corner cover for changing the direction of the WDK trunking.

Trunking, type WDK 100230

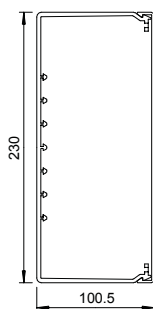

| Type | Colour | Length mm | Pack m | Weight kg/100 m | Item no. |
|--------------|------------|--------------|-----------|--------------------|----------|
| WDK100230RW | Pure white | 2000 | 4 | 338.000 | 6191355 |
| WDK100230CW | Cream | 2000 | 4 | 338.000 | 6026338 |
| WDK100230LGR | Light grey | 2000 | 4 | 338.000 | 6027253 |
| WDK100230GR | Stone grey | 2000 | 4 | 338.000 | 6026311 |

Wall installation trunking as trunking base with base perforation and matching trunking cover.

Four cover fixing devices included.

End piece, trunking type WDK 100230

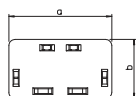

| Type | Colour | Dim. a mm | Dim. b mm | Pack Piece | Weight kg/100 pc. | Item no. |
|-----------------|------------|-----------------|-----------------|---------------|----------------------|----------|
| WDK HE100230RW | Pure white | 230 | 100 | 5 | 10.409 | 6193399 |
| WDK HE100230CW | Cream | 230 | 100 | 5 | 10.237 | 6163076 |
| WDK HE100230LGR | Light grey | 230 | 100 | 5 | 10.237 | 6183980 |
| WDK HE100230GR | Stone grey | 230 | 100 | 5 | 10.237 | 6024904 |

End piece to close the WDK trunking.

T piece, for trunking type WDK 100230

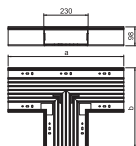

| Type | Colour | Dim. a mm | Pack Piece | Weight kg/100 pc. | Item no. |
|---------------|------------|-----------------|---------------|----------------------|----------|
| WDK T100230RW | Pure white | 600 | 1 | 248.800 | 6183992 |

T piece to change the direction of the WDK trunking.

Internal corner cover, trunking type WDK 100230

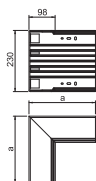
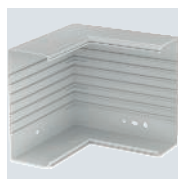

| Type | Colour | Dim. a mm | Pack Piece | Weight kg/100 pc. | Item no. |
|----------------|------------|-----------------|---------------|----------------------|----------|
| WDK I100230GR | Stone grey | 250 | 2 | 109.000 | 6193030 |
| WDK I100230CW | Cream | 250 | 2 | 109.000 | 6193026 |
| WDK I100230LGR | Light grey | 250 | 2 | 109.000 | 6193034 |
| WDK I100230RW | Pure white | 250 | 2 | 109.000 | 6193081 |

Internal corner cover for changing the direction of the WDK trunking.



WDK device socket, type 2390

PVC
CE

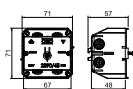

| Type | Colour | Pack Piece | Weight kg/100 pc. | Item no. |
|------|------------|------------|-------------------|----------|
| 2390 | Light grey | 5 | 4.398 | 6023207 |

Accessory mounting box for the installation of devices with support rings and support clamps in WDK cable routing trunking of 60 mm trunking height. The device socket is placed on the floor connectors and fastened in the centre with a bolt.

WDK CEE device socket

PA/GF
CE

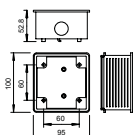
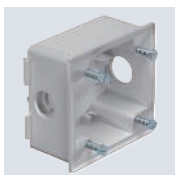

| Type | Colour | Pack Piece | Weight kg/100 pc. | Item no. |
|------|------------|------------|-------------------|----------|
| 2392 | Light grey | 5 | 10.500 | 6024009 |

Underfloor box for mounting CEE sockets in WDK trunking. Also suitable as concealed installation box for CEE sockets.

WDK CEE adapter flange 16 A

PA
CE

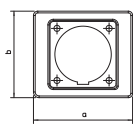
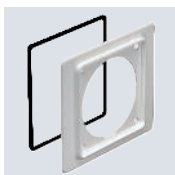

| Type | Colour | Dim. a mm | Dim. b mm | Pack Piece | Weight kg/100 pc. | Item no. |
|---------|------------|-----------|-----------|------------|-------------------|----------|
| 2393 16 | Light grey | 110 | 96 | 5 | 2.401 | 6024025 |

Adapter flange for mounting CEE 16 A sockets. During the mounting of the CEE mounting box, the adapter flange is mounted behind the trunking cover for accessory mounting boxes. Suitable for 400 V CEE 16 A 5-pin 6h, art. no. 6109874.

WDK CEE adapter flange 32 A

PVC
CE

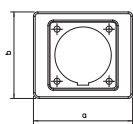

| Type | Colour | Dim. a mm | Dim. b mm | Pack Piece | Weight kg/100 pc. | Item no. |
|---------|------------|-----------|-----------|------------|-------------------|----------|
| 2393 32 | Stone grey | 110 | 96 | 5 | 4.000 | 6024033 |

Adapter flange for CEE 32 A sockets.

Device support, Modul 45

PC

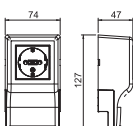

| Type | Colour | Pack Piece | Weight kg/100 pc. | Item no. |
|--------------|------------|------------|-------------------|----------|
| WDK GT1M45RW | Pure white | 1 | 6.000 | 6154893 |

Single device support for mounting on WDK wall and ceiling trunking of the types WDK 12022, WDK 15030, WDK 15040 and WDK 20050. The device is only suitable for accepting Modul 45 devices.

PA

CEE adapter flange 16 A, concealed



| Type | Colour | Pack Piece | Weight kg/100 pc. | Item no. |
|---------|------------|------------|-------------------|----------|
| 2393 UP | Light grey | 5 | 4.416 | 6024106 |

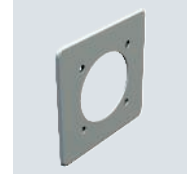
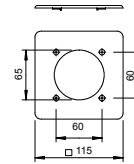

The cover plate, together with the concealed installation box, allows tidy wall closure.

Partitions

PVC

Partition for WDK trunking, trunking height 40 mm



| Type | Colour | Length mm | Pack m | Weight kg/100 m | Item no. |
|---------|------------|-----------|--------|-----------------|----------|
| 2371 40 | Light grey | 2000 | 2 | 13.500 | 6023096 |

Partition to divide the WDK trunking, with 40 mm trunking height, and various ISS service poles for the installation of different voltage levels.

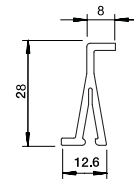

PVC

Partition for WDK trunking, trunking height 60 mm



| Type | Colour | Length mm | Pack m | Weight kg/100 m | Item no. |
|---------|------------|-----------|--------|-----------------|----------|
| 2371 60 | Light grey | 2000 | 2 | 17.000 | 6023118 |

Partition to divide the WDK trunking, with 60 mm trunking height for the installation of different voltage levels.

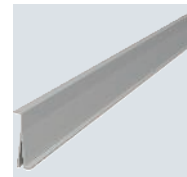
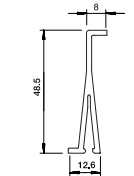

PVC

Partition for WDK trunking, trunking height 80 mm



| Type | Colour | Length mm | Pack m | Weight kg/100 m | Item no. |
|---------|------------|-----------|--------|-----------------|----------|
| 2371 80 | Light grey | 2000 | 2 | 33.000 | 6026982 |

Partition to divide the WDK trunking, with 80 mm trunking height for the installation of different voltage levels.

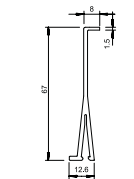

PVC

Partition for WDK trunking, trunking height 100 mm



| Type | Colour | Length mm | Pack m | Weight kg/100 m | Item no. |
|----------|------------|-----------|--------|-----------------|----------|
| 2371 100 | Light grey | 2000 | 2 | 40.000 | 6026990 |

Partition to divide the WDK trunking, with 100 mm trunking height for the installation of different voltage levels.

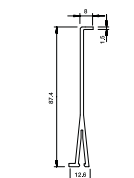

Cover for single accessory mounting box for WDK trunking, trunking height 110 mm

PVC

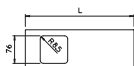

| Type | Colour | Length mm | Pack Piece | Weight kg/100 pc. | Item no. |
|------------|------------|--------------|---------------|----------------------|----------|
| D2-1 110RW | Pure white | 300 | 1 | 8.000 | 6194036 |
| D2-1 110CW | Cream | 300 | 10 | 8.000 | 6169309 |

Cover section, single, for device installation in WDK trunking in conjunction with the device installation socket, type 2390.

Cover for single accessory mounting box for WDK trunking, trunking height 130 mm

PVC

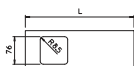

| Type | Colour | Length mm | Pack Piece | Weight kg/100 pc. | Item no. |
|------------|------------|--------------|---------------|----------------------|----------|
| D2-1 130RW | Pure white | 300 | 1 | 9.000 | 6194044 |
| D2-1 130CW | Cream | 300 | 10 | 9.000 | 6169317 |

Cover section, single, for device installation in WDK trunking in conjunction with the device installation socket, type 2390.

Cover for single accessory mounting box for WDK trunking, trunking height 150 mm

PVC

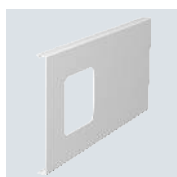

| Type | Colour | Length mm | Pack Piece | Weight kg/100 pc. | Item no. |
|------------|------------|--------------|---------------|----------------------|----------|
| D2-1 150RW | Pure white | 300 | 1 | 10.000 | 6194052 |

Cover section, single, for device installation in WDK trunking in conjunction with the device installation socket, type 2390.

Cover for single accessory mounting box for WDK trunking, trunking height 170 mm

PVC



| Type | Colour | Length mm | Pack Piece | Weight kg/100 pc. | Item no. |
|------------|------------|--------------|---------------|----------------------|----------|
| D2-1 170RW | Pure white | 300 | 1 | 13.400 | 6194060 |

Cover section, single, for device installation in WDK trunking in conjunction with the device installation socket, type 2390.

Cover for double accessory mounting box for WDK trunking, trunking height 110 mm

PVC

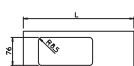

| Type | Colour | Length mm | Pack Piece | Weight kg/100 pc. | Item no. |
|------------|------------|--------------|---------------|----------------------|----------|
| D2-2 110RW | Pure white | 300 | 1 | 6.500 | 6194109 |
| D2-2 110CW | Cream | 300 | 10 | 6.500 | 6169376 |
| D2-2 110GR | Stone grey | 300 | 10 | 6.500 | 6159370 |

Cover section, double, for device installation in WDK trunking in conjunction with the device installation socket, type 2390.

PVC

**Cover for double accessory mounting box for WDK trunking, trunking height 130 mm**

| Type | Colour | Length mm | Pack Piece | Weight kg/100 pc. | Item no. |
|------------|------------|--------------|---------------|----------------------|----------|
| D2-2 130RW | Pure white | 300 | 1 | 7.500 | 6194117 |
| D2-2 130CW | Cream | 300 | 10 | 7.500 | 6169384 |

Cover section, double, for device installation in WDK trunking in conjunction with the device installation socket, type 2390.

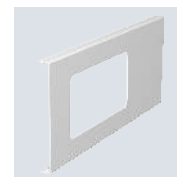
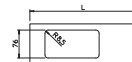

PVC

**Cover for double accessory mounting box for WDK trunking, trunking height 150 mm**

| Type | Colour | Length mm | Pack Piece | Weight kg/100 pc. | Item no. |
|------------|------------|--------------|---------------|----------------------|----------|
| D2-2 150RW | Pure white | 300 | 1 | 9.000 | 6194125 |
| D2-2 150CW | Cream | 300 | 10 | 9.000 | 6169368 |

Cover section, double, for device installation in WDK trunking in conjunction with the device installation socket, type 2390.

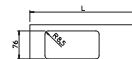

PVC

**Cover for double accessory mounting box for WDK trunking, trunking height 170 mm**

| Type | Colour | Length mm | Pack Piece | Weight kg/100 pc. | Item no. |
|------------|------------|--------------|---------------|----------------------|----------|
| D2-2 170RW | Pure white | 300 | 1 | 12.000 | 6194133 |

Cover section, double, for device installation in WDK trunking in conjunction with the device installation socket, type 2390.

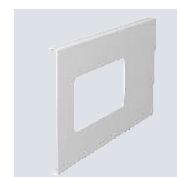
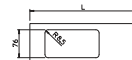

PVC

**Cover for double accessory mounting box for WDK trunking, trunking height 210 mm**

| Type | Colour | Length mm | Pack Piece | Weight kg/100 pc. | Item no. |
|------------|------------|--------------|---------------|----------------------|----------|
| D2-2 210RW | Pure white | 300 | 1 | 17.700 | 6194141 |

Cover section, double, for device installation in WDK trunking in conjunction with the device installation socket, type 2390.

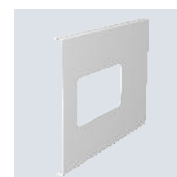
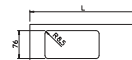

PVC

**Cover for triple accessory mounting box for WDK trunking, trunking height 110 mm**

| Type | Colour | Length mm | Pack Piece | Weight kg/100 pc. | Item no. |
|------------|------------|--------------|---------------|----------------------|----------|
| D2-3 110RW | Pure white | 300 | 1 | 5.000 | 6194184 |
| D2-3 110CW | Cream | 300 | 10 | 5.000 | 6169430 |

Cover section, triple, for device installation in WDK trunking in conjunction with the device installation socket, type 2390.

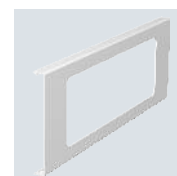

Cover for triple accessory mounting box for WDK trunking, trunking height 130 mm

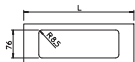

| Type | Colour | Length mm | Pack Piece | Weight kg/100 pc. | Item no. |
|------------|------------|--------------|---------------|----------------------|----------|
| D2-3 130RW | Pure white | 300 | 1 | 6.200 | 6194192 |
| D2-3 130CW | Cream | 300 | 10 | 6.200 | 6169449 |

Cover section, triple, for device installation in WDK trunking in conjunction with the device installation socket, type 2390.

Cover for triple accessory mounting box for WDK trunking, trunking height 150 mm

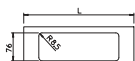

| Type | Colour | Length mm | Pack Piece | Weight kg/100 pc. | Item no. |
|------------|------------|--------------|---------------|----------------------|----------|
| D2-3 150RW | Pure white | 300 | 10 | 9.500 | 6194206 |
| D2-3 150CW | Cream | 300 | 10 | 9.500 | 6169422 |

Cover section, triple, for device installation in WDK trunking in conjunction with the device installation socket, type 2390.

Cover for triple accessory mounting box for WDK trunking, trunking height 170 mm

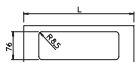
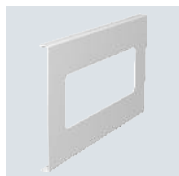

| Type | Colour | Length mm | Pack Piece | Weight kg/100 pc. | Item no. |
|------------|------------|--------------|---------------|----------------------|----------|
| D2-3 170RW | Pure white | 300 | 1 | 10.300 | 6194214 |

Cover section, triple, for device installation in WDK trunking in conjunction with the device installation socket, type 2390.

Cover for WDK trunking, trunking width 40 mm



| Type | Colour | Length mm | Pack m | Weight kg/100 m | Item no. |
|-----------|------------|--------------|-----------|--------------------|----------|
| 2410 40GR | Stone grey | 2000 | 2 | 11.300 | 6022669 |
| 2410 40CW | Cream | 2000 | 2 | 11.300 | 6027601 |
| 2410 40RW | Pure white | 2000 | 2 | 11.300 | 6191568 |

Cover for closing the trunking.

Cover for WDK trunking, trunking width 60 mm

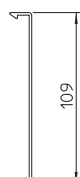

| Type | Colour | Length mm | Pack m | Weight kg/100 m | Item no. |
|------------|------------|--------------|-----------|--------------------|----------|
| 2410 60GR | Stone grey | 2000 | 2 | 15.400 | 6022685 |
| 2410 60CW | Cream | 2000 | 2 | 15.400 | 6027660 |
| 2410 60LGR | Light grey | 2000 | 2 | 15.400 | 6028136 |
| 2410 60RW | Pure white | 2000 | 2 | 15.400 | 6191592 |

Cover for closing the trunking.

PVC



Cover for WDK trunking, trunking width 90 mm

| Type | Colour | Length mm | Pack m | Weight kg/100 m | Item no. |
|-----------|------------|--------------|-----------|--------------------|----------|
| 2410 90GR | Stone grey | 2000 | 2 | 26.500 | 6022707 |
| 2410 90CW | Cream | 2000 | 2 | 26.500 | 6027636 |

Cover for closing the trunking.

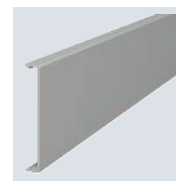

PVC



Cover for WDK trunking, trunking width 110 mm

| Type | Colour | Length mm | Pack m | Weight kg/100 m | Item no. |
|------------|--------|--------------|-----------|--------------------|----------|
| 2410 110CW | Cream | 2000 | 2 | 34.000 | 6027644 |

Cover for closing the trunking.



PVC



Cover for WDK trunking, trunking width 130 mm

| Type | Colour | Length mm | Pack m | Weight kg/100 m | Item no. |
|------------|------------|--------------|-----------|--------------------|----------|
| 2410 130GR | Stone grey | 2000 | 2 | 42.000 | 6022723 |
| 2410 130CW | Cream | 2000 | 2 | 42.000 | 6027652 |
| 2410 130RW | Pure white | 2000 | 2 | 42.000 | 6191657 |

Cover for closing the trunking.

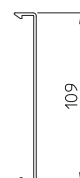

PVC



Cover for WDK trunking, trunking width 150 mm

| Type | Colour | Length mm | Pack m | Weight kg/100 m | Item no. |
|------------|------------|--------------|-----------|--------------------|----------|
| 2410 150GR | Stone grey | 2000 | 2 | 54.000 | 6022731 |
| 2410 150RW | Pure white | 2000 | 2 | 54.000 | 6191673 |

Cover for closing the trunking.

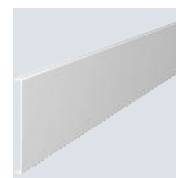
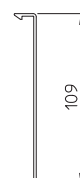

PVC



Cover for WDK trunking, trunking width 170 mm

| Type | Colour | Length mm | Pack m | Weight kg/100 m | Item no. |
|------------|--------|--------------|-----------|--------------------|----------|
| 2410 170CW | Cream | 2000 | 52 | 56.700 | 6027679 |

Cover for closing the trunking.

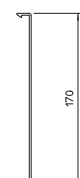

Cover for WDK trunking, trunking width 210 mm

PVC



| Type | Colour | Length mm | Pack m | Weight kg/100 m | Item no. |
|------------|------------|--------------|-----------|--------------------|----------|
| 2410 210GR | Stone grey | 2000 | 2 | 72.200 | 6022774 |
| 2410 210CW | Cream | 2000 | 2 | 72.200 | 6027687 |
| 2410 210RW | Pure white | 2000 | 2 | 72.200 | 6191738 |

Cover for closing the trunking.

Cover for WDK trunking, trunking width 230 mm

PVC



| Type | Colour | Length mm | Pack m | Weight kg/100 m | Item no. |
|------------|--------|--------------|-----------|--------------------|----------|
| 2410 230CW | Cream | 2000 | 28 | 78.500 | 6027504 |

Cover for closing the trunking.

Cover for single accessory mounting box for WDK trunking, trunking height 170 mm

PVC



| Type | Colour | Length mm | Pack Piece | Weight kg/100 pc. | Item no. |
|------------|--------|--------------|---------------|----------------------|----------|
| D2-1 170CW | Cream | 300 | 10 | 13.400 | 6169325 |

Cover section, single, for device installation in WDK trunking in conjunction with the device installation socket, type 2390.

Cover clips

Cover clip for WDKH trunking, trunking width 60 mm

PC/
ABS

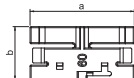
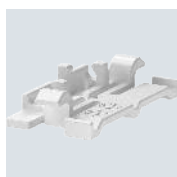

| Type | Colour | Dim. a mm | Dim. b mm | Pack Piece | Weight kg/100 pc. | Item no. |
|---------|------------|-----------------|-----------------|---------------|----------------------|----------|
| OTK H60 | Pure white | 48.8 | 24.8 | 10 | 0.400 | 6176122 |

Cover clip for better and easier laying of lines in the WDKH trunking.

Cover clip for WDKH trunking, trunking width 90 mm

PC/
ABS

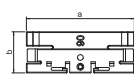
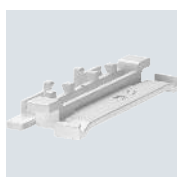

| Type | Colour | Dim. a mm | Dim. b mm | Pack Piece | Weight kg/100 pc. | Item no. |
|---------|------------|-----------------|-----------------|---------------|----------------------|----------|
| OTK H90 | Pure white | 75.7 | 28.8 | 10 | 0.900 | 6176125 |

Cover clip for better and easier laying of lines in the WDKH trunking.

PC/
ABS

Cover clip for WDKH trunking, trunking width 110 mm

| Type | Colour | Dim. | | Pack Piece | Weight kg/100 pc. | Item no. |
|----------|------------|---------|---------|---------------|----------------------|----------|
| | | a mm | b mm | | | |
| OTK H110 | Pure white | 95.7 | 28.8 | 10 | 1.200 | 6176128 |

Cover clip for better and easier laying of lines in the WDKH trunking.

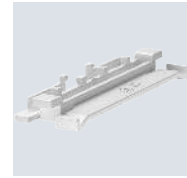
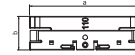
PC/
ABS

Cover clip for WDKH trunking, trunking width 150 mm

| Type | Colour | Dim. | | Pack Piece | Weight kg/100 pc. | Item no. |
|----------|------------|---------|---------|---------------|----------------------|----------|
| | | a mm | b mm | | | |
| OTK H150 | Pure white | 136.2 | 36 | 10 | 2.050 | 6176131 |

Cover clip for better and easier laying of lines in the WDKH trunking.

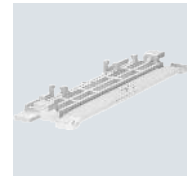
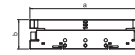

PVC



Cover clip for WDK trunking, trunking width 60 mm

| Type | Colour | Dim. | | Pack Piece | Weight kg/100 pc. | Item no. |
|---------|------------|---------|---------|---------------|----------------------|----------|
| | | a mm | b mm | | | |
| 2370 60 | Light grey | 48.8 | 24.8 | 20 | 0.500 | 6022995 |

Cover clip for better and easier laying of lines in the WDK trunking.

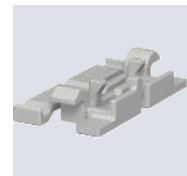
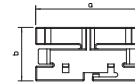

PVC



Cover clip for WDK trunking, trunking width 90 mm

| Type | Colour | Dim. | | Pack Piece | Weight kg/100 pc. | Item no. |
|---------|------------|---------|---------|---------------|----------------------|----------|
| | | a mm | b mm | | | |
| 2370 90 | Light grey | 75.7 | 28.8 | 20 | 1.100 | 6023509 |

Cover clip for better and easier laying of lines in the WDK trunking.

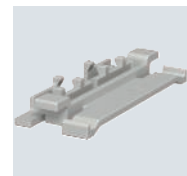
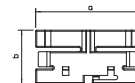

PVC



Cover clip for WDK trunking, trunking width 110 mm

| Type | Colour | Dim. | | Pack Piece | Weight kg/100 pc. | Item no. |
|----------|------------|---------|---------|---------------|----------------------|----------|
| | | a mm | b mm | | | |
| 2370 110 | Light grey | 95.7 | 28.8 | 20 | 1.400 | 6023517 |

Cover clip for better and easier laying of lines in the WDK trunking.

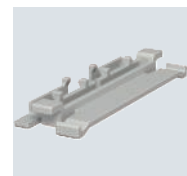

Cover clip for WDK trunking, trunking width 130 mm

PVC

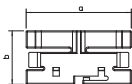
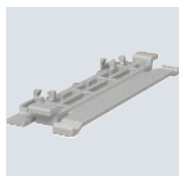

| Type | Colour | Dim. | | Pack Piece | Weight kg/100 pc. | Item no. |
|----------|------------|-------|------|------------|-------------------|----------|
| | | a mm | b mm | | | |
| 2370 130 | Light grey | 116.2 | 36 | 20 | 2.500 | 6023525 |

Cover clip for better and easier laying of lines in the WDK trunking.

Cover clip for WDK trunking, trunking width 150 mm

PVC

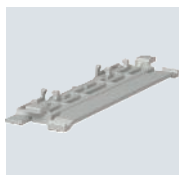

| Type | Colour | Dim. | | Pack Piece | Weight kg/100 pc. | Item no. |
|----------|------------|-------|------|------------|-------------------|----------|
| | | a mm | b mm | | | |
| 2370 150 | Light grey | 136.2 | 36 | 20 | 2.050 | 6023533 |

Cover clip for better and easier laying of lines in the WDK trunking.

Cover clip for WDK trunking, trunking width 170 mm

PVC

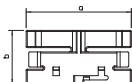
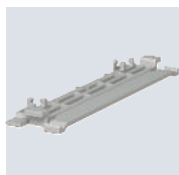

| Type | Colour | Dim. | | Pack Piece | Weight kg/100 pc. | Item no. |
|----------|------------|-------|------|------------|-------------------|----------|
| | | a mm | b mm | | | |
| 2370 170 | Light grey | 156.7 | 36 | 20 | 3.300 | 6023541 |

Cover clip for better and easier laying of lines in the WDK trunking.

Cover clip for WDK trunking, trunking width 210 mm

PVC

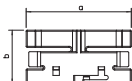
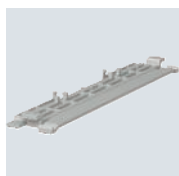

| Type | Colour | Dim. | | Pack Piece | Weight kg/100 pc. | Item no. |
|----------|------------|-------|------|------------|-------------------|----------|
| | | a mm | b mm | | | |
| 2370 210 | Light grey | 197.2 | 36 | 20 | 3.900 | 6023576 |

Cover clip for better and easier laying of lines in the WDK trunking.

Cover clip for WDK trunking, trunking width 230 mm

PVC



| Type | Colour | Dim. | | Pack Piece | Weight kg/100 pc. | Item no. |
|----------|------------|-------|------|------------|-------------------|----------|
| | | a mm | b mm | | | |
| 2370 230 | Light grey | 216.2 | 36 | 20 | 4.800 | 6023584 |

Cover clip for better and easier laying of lines in the WDK trunking.

St



Shears for WDK trunking, straight cut

| Type | Pack Piece | Weight kg/100 pc. | Item no. |
|--------|------------|-------------------|----------|
| SK2545 | 1 | 40.000 | 6028403 |

Cutters for WDK trunking up to dimensions 25 x 45 mm.



St



Shears for WDK trunking, mitre cut

| Type | Pack Piece | Weight kg/100 pc. | Item no. |
|--------|------------|-------------------|----------|
| SG2545 | 1 | 50.000 | 6028411 |

Shears for mitre cuts of the WDK trunking up to the dimensions 25 x 45 mm.



Adapter

PA



WDK adapter, device installation for 71GD series

| Type | Pack Piece | Weight kg/100 pc. | Item no. |
|---------|------------|-------------------|----------|
| MA45WDK | 1 | 1.200 | 6024070 |

Adapter for the installation of accessory mounting boxes of the 71GD... series in WDK wall and ceiling trunking. The use of accessory mounting boxes, type 71GD8 and 71GD9, permit standardised installation of Modul 45 devices. Devices can be installed in the trunking heights 110, 130 and 150 mm. Combined with device covers of the AR45... series, finished cover sections of the OT GE ... series can cover the switching and connection devices.

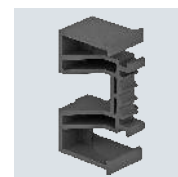
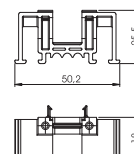

PP



Mounting aid for WDK trunking

| Type | Colour | Pack Piece | Weight kg/100 pc. | Item no. |
|--------|---------------|------------|-------------------|----------|
| WDK MH | Pastel orange | 3 | 0.524 | 6028430 |

Mounting aid WDK for mounting WDK trunking single-handedly.

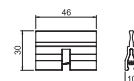

Anchors

PA



Knock-in anchor

| Type | Dowel Ø mm | Length mm | Pull-out force N min/concrete | Pack Piece | Weight kg/100 pc. | Item no. |
|-------------|------------|-----------|-------------------------------|------------|-------------------|----------|
| 910 SD 6X35 | 6 | 35 | 260 | 100 | 0.310 | 2351056 |

Knock-in anchor: steel, electrogalvanised and transparently passivated.



Cover, universal trunking

PVC

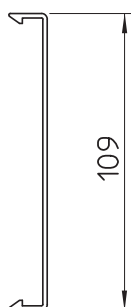

| Type | Colour | Length mm | Pack m | Weight kg/100 m | Item no. |
|-------------|------------|--------------|-----------|--------------------|----------|
| 2410 110LGR | Light grey | 2000 | 2 | 34.000 | 6028152 |
| 2410 110GR | Stone grey | 2000 | 2 | 34.000 | 6022715 |

Cover for creating the universal trunking.

Front cover, universal trunking

PVC

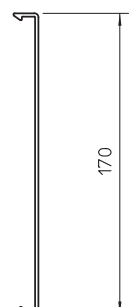
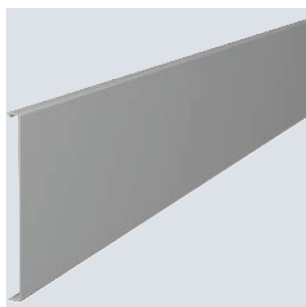

| Type | Colour | Length mm | Pack m | Weight kg/100 m | Item no. |
|-------------|------------|--------------|-----------|--------------------|----------|
| 2410 170RW | Pure white | 2000 | 2 | 56.700 | 6191703 |
| 2410 170LGR | Light grey | 2000 | 2 | 56.700 | 6028187 |
| 2410 170GR | Stone grey | 2000 | 2 | 56.700 | 6022758 |

Front cover for creating the universal trunking.

End piece, universal trunking

PVC

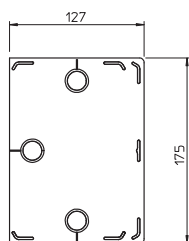
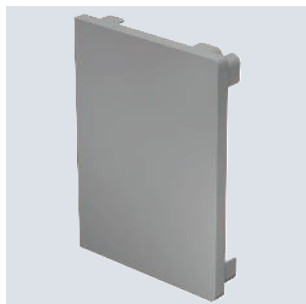

| Type | Colour | Pack Piece | Weight kg/100 pc. | Item no. |
|-------------|------------|---------------|----------------------|----------|
| RK-E1117LGR | Light grey | 2 | 13.500 | 6156231 |
| RK-E1117GR | Stone grey | 2 | 13.500 | 6156223 |

End piece for fastening and side closing of the universal trunking. The required fastening clips, type 2955 GL, are included.

Cover clip, universal trunking

St FS

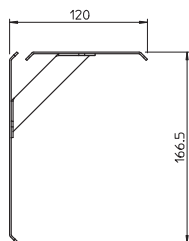

| Type | Pack Piece | Weight kg/100 pc. | Item no. |
|----------|---------------|----------------------|----------|
| RK-K1117 | 2 | 9.000 | 6156207 |

Cover clip for fixing the covers of the universal trunking. These are required to prevent the covers from sagging.

PVC



Cover, universal trunking

| Type | Colour | Length mm | Pack m | Weight kg/100 m | Item no. |
|------------|------------|--------------|-----------|--------------------|----------|
| 2410 110RW | Pure white | 2000 | 2 | 34.000 | 6191630 |

Cover for creating the universal trunking.

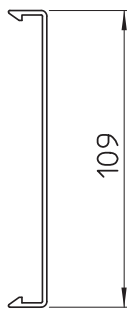

ECK 35 corner trunking, trunking width 35

PVC

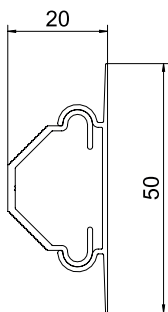
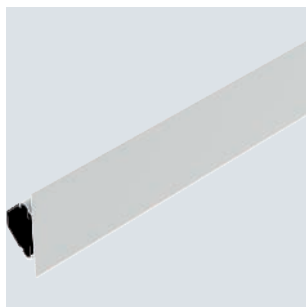

| Type | Colour | Length mm | Width mm | Height mm | Pack m | Weight kg/100 m | Item no. |
|---------------------|------------|--------------|-------------|--------------|-----------|--------------------|----------------|
| ECK 3535 rws | Pure white | 2000 | 50 | 35 | 60 | 18.400 | 6131155 |
| ECK 3535 rws | Pure white | 2500 | 50 | 35 | 75 | 18.400 | 6131154 |
| ECK 3535 cws | Cream | 2000 | 50 | 35 | 60 | 18.400 | 6131153 |
| ECK 3535 cws | Cream | 2500 | 50 | 35 | 75 | 18.400 | 6131152 |

Corner trunking for vertical/horizontal cable routing in indoor corner areas.

Internal corner TRI IE350350

PVC

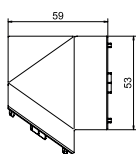

| Type | Colour | Length mm | Width mm | Height mm | Pack Piece | Weight kg/100 pc. | Item no. |
|-------------------------|------------|--------------|-------------|--------------|---------------|----------------------|----------------|
| TRI IE350350 rws | Pure white | 68 | 68 | 5 | 10 | 1.580 | 6131171 |

Internal corner as a fitting for changing the direction of the RAUTRIGO corner trunking.

End piece TRI ES350350

PVC

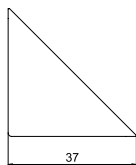

| Type | Colour | Length mm | Width mm | Height mm | Pack Piece | Weight kg/100 pc. | Item no. |
|-------------------------|------------|--------------|-------------|--------------|---------------|----------------------|----------------|
| TRI ES350350 rws | Pure white | 55 | 35 | 25 | 10 | 0.300 | 6131179 |

End piece as a fitting for the RAUTRIGO corner trunking.

Cover TRI 3535 OT

PVC

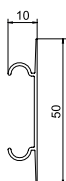

| Type | Colour | Length mm | Width mm | Height mm | Pack m | Weight kg/100 m | Item no. |
|------------------------|------------|--------------|-------------|--------------|-----------|--------------------|----------------|
| TRI 3535 OT rws | Pure white | 2000 | 10 | 50 | 120 | 9.333 | 6131190 |

Cover for closing the RAUTRIGO corner trunking.

Transition piece TRI C 35-16

PVC

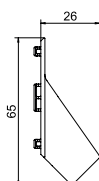

| Type | Colour | Length mm | Width mm | Height mm | Pack Piece | Weight kg/100 pc. | Item no. |
|------------------------|------------|--------------|-------------|--------------|---------------|----------------------|----------------|
| TRI C 35-16 rws | Pure white | 60 | 55 | 40 | 10 | 1.200 | 6131182 |

Transition piece for transition from corner trunking 35 to MKS 1616.

PVC



Transition piece, TRI C 35-16 to SL 20/50

| Type | Colour | Length mm | Width mm | Height mm | Pack Piece | Weight kg/100 pc. | Item no. |
|------------------------|------------|--------------|-------------|--------------|---------------|----------------------|----------------|
| TRI C 35-50 rws | Pure white | 95 | 60 | 60 | 10 | 1.760 | 6131185 |

Transition piece for transition from corner trunking 35 to SL 20/50 skirting trunking.

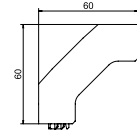

Corner duct, duct height 50

PVC



ECK 50 corner trunking, trunking width 50

| Type | Colour | Length mm | Width mm | Height mm | Pack m | Weight kg/100 m | Item no. |
|---------------------|------------|--------------|-------------|--------------|-----------|--------------------|----------------|
| ECK 5050 rws | Pure white | 2500 | 80 | 50 | 45 | 39.500 | 6131165 |
| ECK 5050 rws | Pure white | 2000 | 80 | 50 | 30 | 39.500 | 6131164 |
| ECK 5050 cws | Cream | 2500 | 80 | 50 | 45 | 39.500 | 6131162 |
| ECK 5050 cws | Cream | 2000 | 80 | 50 | 30 | 39.500 | 6131163 |

Corner trunking for vertical/horizontal cable routing in indoor corner areas.

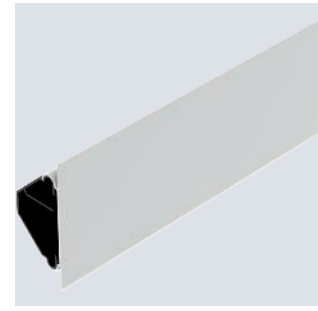
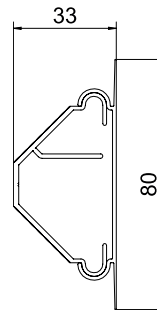

PVC



Internal corner TRI IE500500

| Type | Colour | Length mm | Width mm | Height mm | Pack Piece | Weight kg/100 pc. | Item no. |
|-----------------------|------------|--------------|-------------|--------------|---------------|----------------------|----------------|
| TRI IE5050 rws | Pure white | 85 | 90 | 90 | 10 | 2.580 | 6131172 |

Internal corner as a fitting for changing the direction of the 50 corner trunking.

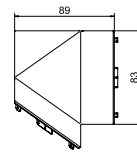

PVC







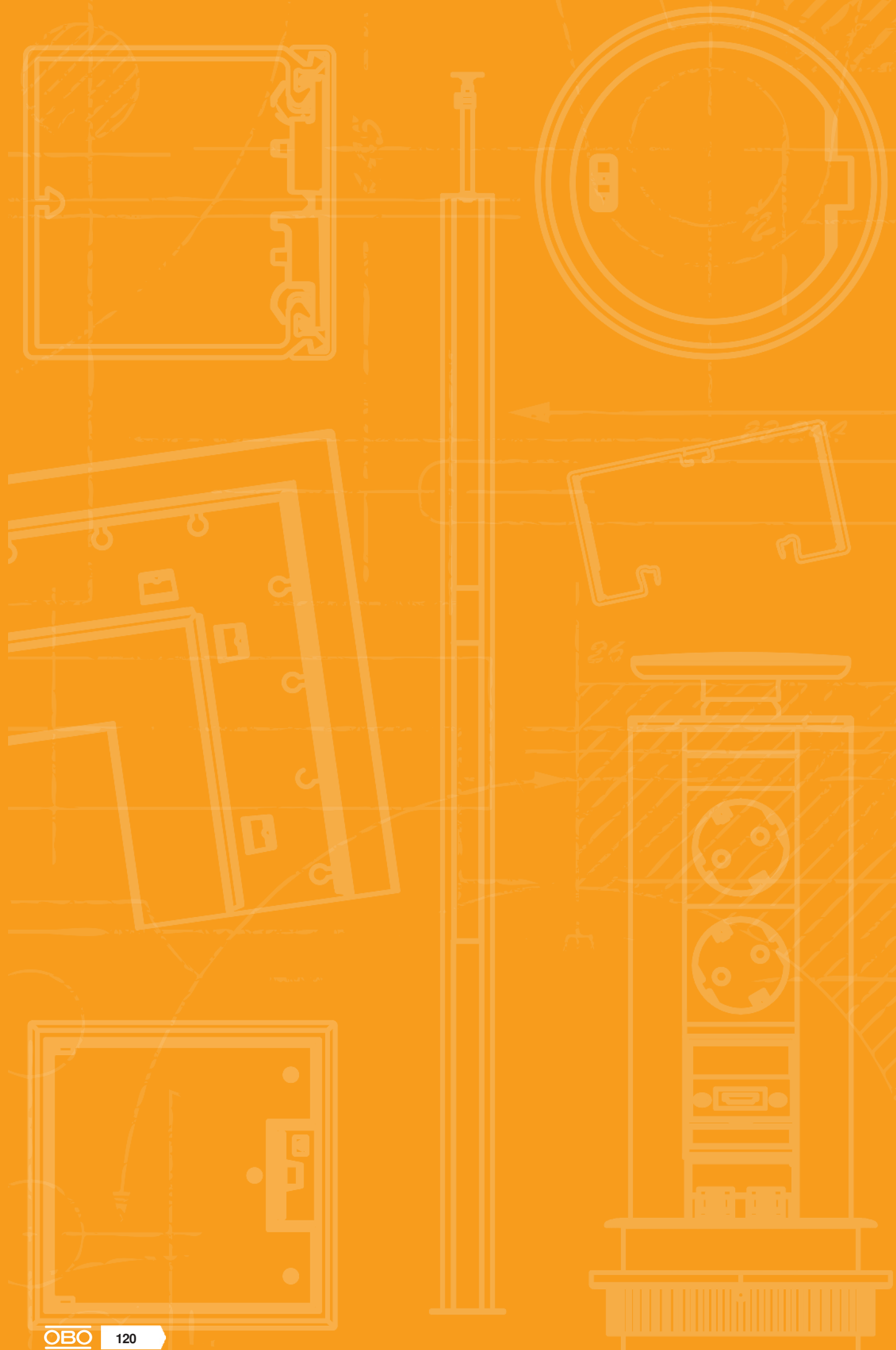

Cover TRI 5050 OT

| Type | Colour | Length mm | Width mm | Height mm | Pack m | Weight kg/100 m | Item no. |
|------------------------|------------|--------------|-------------|--------------|-----------|--------------------|----------------|
| TRI 5050 OT rws | Pure white | 2000 | 12 | 80 | 96 | 15.400 | 6131191 |





Plastic cable routing trunking, halogen-free

| | | |
|---|---|-----|
|  | Nominal height 10 | 122 |
|  | Nominal height 15 | 124 |
|  | Nominal height 20 | 126 |
|  | Nominal height 30 | 128 |
|  | Nominal height 40 | 130 |
|  | Nominal height 60 | 132 |
|  | Accessories, plastic cable routing trunking, halogen-free | 138 |

Trunking, type WDKH 10020

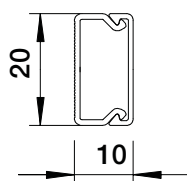

| Type | Colour | Length mm | Pack m | Weight kg/100 m | Item no. |
|--------------|------------|--------------|-----------|--------------------|----------|
| WDKH-10020RW | Pure white | 2000 | 96 | 8.500 | 6175375 |

Trunking cover and base with base perforation made of halogen-free plastic.

Trunking, type WDKH 10020

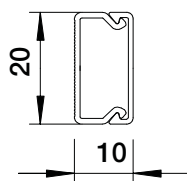

| Type | Colour | Length mm | Pack m | Weight kg/100 m | Item no. |
|----------------|------------|--------------|-----------|--------------------|----------|
| WDKH-10020RW T | Pure white | 2000 | 84 | 9.500 | 6175377 |

Duct cover and base with base perforation made of halogen-free plastic. With self-adhesive film for fastening on the underside.

Internal corner cover, trunking type WDKH 10020

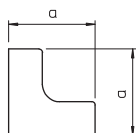
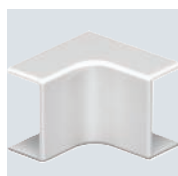

| Type | Colour | Dim. a mm | Pack Piece | Weight kg/100 pc. | Item no. |
|---------------|------------|-----------------|---------------|----------------------|----------|
| WDKH-I10020RW | Pure white | 30 | 4 | 0.252 | 6175572 |

Internal corner cover for changing the direction of the halogen-free WDKH trunking.

External corner cover, trunking type WDKH 10020

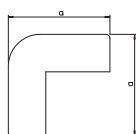

| Type | Colour | Dim. a mm | Pack Piece | Weight kg/100 pc. | Item no. |
|---------------|------------|-----------------|---------------|----------------------|----------|
| WDKH-A10020RW | Pure white | 30 | 4 | 0.332 | 6175612 |

External corner cover for changing the direction of the halogen-free WDKH trunking.

PC/
ABS

T piece cover, for trunking type WDKH 10020

| Type | Colour | Dim. | | Pack Piece | Weight kg/100 pc. | Item no. |
|---------------|------------|------|------|------------|-------------------|----------|
| | | a mm | b mm | | | |
| WDKH-T10020RW | Pure white | 45 | 34 | 4 | 0.298 | 6175684 |

T and intersection cover for changing the direction of the halogen-free WDK-H trunking.

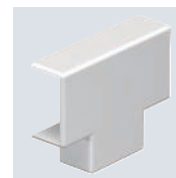
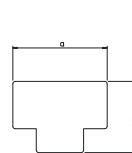

PC/
ABS



Flat angle cover, trunking type WDKH 10020

| Type | Colour | Dim. | | Pack Piece | Weight kg/100 pc. | Item no. |
|---------------|------------|------|------|------------|-------------------|----------|
| | | a mm | b mm | | | |
| WDKH-F10020RW | Pure white | 40 | | 4 | 0.308 | 6175648 |

Flat angle hood for changing the direction of the halogen-free WDKH trunking.

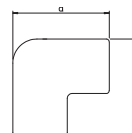

PC/
ABS



End piece, trunking type WDKH 10020

| Type | Colour | Dim. | | Pack Piece | Weight kg/100 pc. | Item no. |
|---------------|------------|------|------|------------|-------------------|----------|
| | | a mm | b mm | | | |
| WDKH-E10020RW | Pure white | 22 | 11 | 10 | 0.092 | 6175540 |

End piece for closing the WDKH trunking.

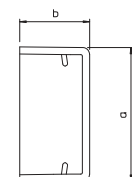

Trunking, type WDKH 15030

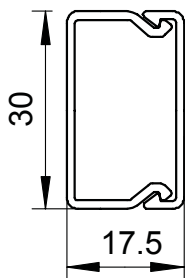

| Type | Colour | Length mm | Pack m | Weight kg/100 m | Item no. |
|---------------|------------|--------------|-----------|--------------------|----------|
| WDKH-15030RW | Pure white | 2000 | 48 | 15.000 | 6175390 |
| WDKH-15030LGR | Light grey | 2000 | 48 | 15.000 | 6175457 |

Trunking cover and base with base perforation made of halogen-free plastic.

Trunking, type WDKH 15030

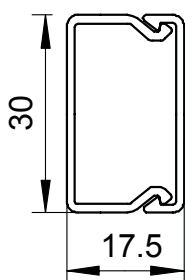

| Type | Colour | Length mm | Pack m | Weight kg/100 m | Item no. |
|----------------|------------|--------------|-----------|--------------------|----------|
| WDKH-15030RW T | Pure white | 2000 | 48 | 16.000 | 6175392 |

Trunking cover and base with base perforation made of halogen-free plastic.

Internal corner cover, trunking type WDKH 15030

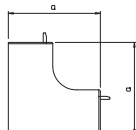
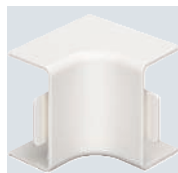

| Type | Colour | Dim. a mm | Pack Piece | Weight kg/100 pc. | Item no. |
|---------------|------------|-----------------|---------------|----------------------|----------|
| WDKH-I15030RW | Pure white | 38.5 | 4 | 0.677 | 6175578 |

Internal corner cover for changing the direction of the halogen-free WDKH trunking.

External corner cover, trunking type WDKH 15030

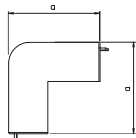
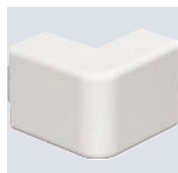

| Type | Colour | Dim. a mm | Pack Piece | Weight kg/100 pc. | Item no. |
|---------------|------------|-----------------|---------------|----------------------|----------|
| WDKH-A15030RW | Pure white | 38.5 | 4 | 0.948 | 6175618 |

External corner cover for changing the direction of the halogen-free WDKH trunking.

PC/
ABS

T piece cover, for trunking type WDK 15030

| Type | Colour | Dim. | | Pack Piece | Weight kg/100 pc. | Item no. |
|---------------|------------|------|------|------------|-------------------|----------|
| | | a mm | b mm | | | |
| WDKH-T15030RW | Pure white | 73 | 53 | 4 | 0.954 | 6175690 |

T and intersection cover for changing the direction of the halogen-free WDK-H trunking.

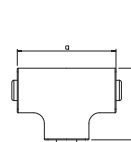

PC/
ABS



Flat angle cover, trunking type WDKH 15030

| Type | Colour | Dim. | | Pack Piece | Weight kg/100 pc. | Item no. |
|---------------|------------|------|------|------------|-------------------|----------|
| | | a mm | b mm | | | |
| WDKH-F15030RW | Pure white | 53 | | 4 | 0.833 | 6175654 |

Flat angle hood for changing the direction of the halogen-free WDKH trunking.

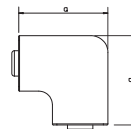

PC/
ABS



End piece, trunking type WDKH 15030

| Type | Colour | Dim. | | Pack Piece | Weight kg/100 pc. | Item no. |
|---------------|------------|------|------|------------|-------------------|----------|
| | | a mm | b mm | | | |
| WDKH-E15030RW | Pure white | 30 | 17 | 10 | 0.200 | 6175546 |

End piece for closing the WDK-H trunking.

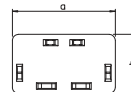

Trunking, type WDKH 20020

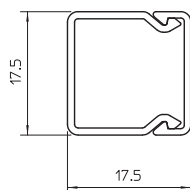

| Type | Colour | Length mm | Pack m | Weight kg/100 m | Item no. |
|---------------|------------|--------------|-----------|--------------------|----------|
| WDKH-20020RW | Pure white | 2000 | 48 | 8.800 | 6175400 |
| WDKH-20020LGR | Light grey | 2000 | 48 | 8.800 | 6175460 |

Trunking cover and base with base perforation made of halogen-free plastic.

Internal corner cover, trunking type WDKH 20020

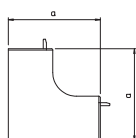
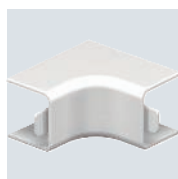

| Type | Colour | Dim. a mm | Pack Piece | Weight kg/100 pc. | Item no. |
|----------------|------------|-----------------|---------------|----------------------|----------|
| WDKH-I20020RW | Pure white | 38.5 | 4 | 0.540 | 6175581 |
| WDKH-I20020LGR | Light grey | 38.5 | 4 | 0.450 | 6175964 |

Internal corner cover for changing the direction of the halogen-free WDKH trunking.

External corner cover, trunking type WDKH 20020

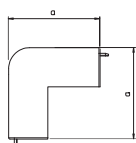
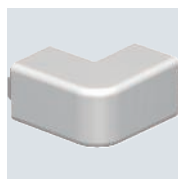

| Type | Colour | Dim. a mm | Pack Piece | Weight kg/100 pc. | Item no. |
|----------------|------------|-----------------|---------------|----------------------|----------|
| WDKH-A20020RW | Pure white | 38.5 | 4 | 0.578 | 6175624 |
| WDKH-A20020LGR | Light grey | 38.5 | 4 | 0.520 | 6176000 |

External corner cover for changing the direction of the halogen-free WDKH trunking.

T piece cover for trunking type WDKH 20020

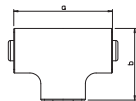

| Type | Colour | Dim. a mm | Dim. b mm | Pack Piece | Weight kg/100 pc. | Item no. |
|----------------|------------|-----------------|-----------------|---------------|----------------------|----------|
| WDKH-T20020RW | Pure white | 57 | 39 | 4 | 0.659 | 6175694 |
| WDKH-T20020LGR | Light grey | 57 | 39 | 4 | 0.659 | 6176072 |

T and intersection cover for changing the direction of the halogen-free WDKH trunking.

Flat angle cover, trunking type WDKH 20020

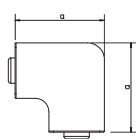

| Type | Colour | Dim. a mm | Pack Piece | Weight kg/100 pc. | Item no. |
|----------------|------------|-----------------|---------------|----------------------|----------|
| WDKH-F20020RW | Pure white | 38 | 4 | 0.502 | 6175658 |
| WDKH-F20020LGR | Light grey | 38 | 4 | 0.502 | 6176036 |

Flat angle hood for changing the direction of the halogen-free WDKH trunking.

PC /
ABS



End piece, trunking type WDKH 20020

| Type | Colour | Dim. a mm | Dim. b mm | Pack Piece | Weight kg/100 pc. | Item no. |
|----------------|------------|-----------------|-----------------|---------------|----------------------|----------|
| WDKH-E20020RW | Pure white | 19 | 18 | 10 | 0.087 | 6175550 |
| WDKH-E20020LGR | Light grey | 19 | 18 | 10 | 0.089 | 6175928 |

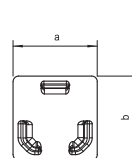

End piece for closing the WDK-H trunking.

Trunking, type WDKH 30045

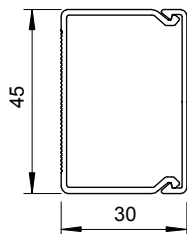
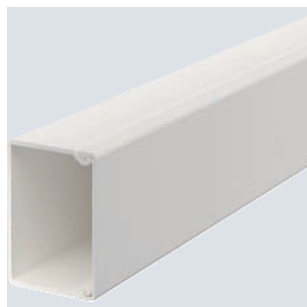

| Type | Colour | Length mm | Pack m | Weight kg/100 m | Item no. |
|---------------|------------|--------------|-----------|--------------------|----------|
| WDKH-30045RW | Pure white | 2000 | 48 | 24.900 | 6175405 |
| WDKH-30045LGR | Light grey | 2000 | 48 | 24.900 | 6175463 |

Trunking cover and base with base perforation made of halogen-free plastic.

Internal corner cover, trunking type WDKH 30045

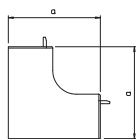
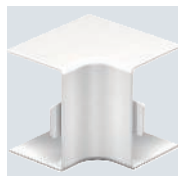

| Type | Colour | Dim. a mm | Pack Piece | Weight kg/100 pc. | Item no. |
|----------------|------------|-----------------|---------------|----------------------|----------|
| WDKH-I30045RW | Pure white | 60 | 4 | 1.144 | 6175590 |
| WDKH-I30045LGR | Light grey | 60 | 4 | 1.144 | 6175968 |

Internal corner cover for changing the direction of the halogen-free WDKH trunking.

External corner cover, trunking type WDKH 30045

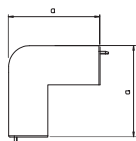

| Type | Colour | Dim. a mm | Pack Piece | Weight kg/100 pc. | Item no. |
|----------------|------------|-----------------|---------------|----------------------|----------|
| WDKH-A30045RW | Pure white | 57 | 4 | 2.000 | 6175626 |
| WDKH-A30045LGR | Light grey | 57 | 4 | 2.000 | 6176004 |

External corner cover for changing the direction of the halogen-free WDKH trunking.

Flat angle cover, trunking type WDKH 30045

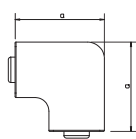

| Type | Colour | Dim. a mm | Pack Piece | Weight kg/100 pc. | Item no. |
|----------------|------------|-----------------|---------------|----------------------|----------|
| WDKH-F30045RW | Pure white | 60 | 4 | 1.652 | 6175662 |
| WDKH-F30045LGR | Light grey | 60 | 4 | 1.652 | 6176040 |

Flat angle hood for changing the direction of the halogen-free WDKH trunking.

T and intersection cover, for trunking type WDK 30045

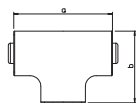

| Type | Colour | Dim. a mm | Dim. b mm | Pack Piece | Weight kg/100 pc. | Item no. |
|----------------|------------|-----------------|-----------------|---------------|----------------------|----------|
| WDKH-T30045RW | Pure white | 88 | 68 | 4 | 1.803 | 6175698 |
| WDKH-T30045LGR | Light grey | 88 | 68 | 4 | 1.803 | 6176076 |

T and intersection cover for changing the direction of the halogen-free WDK-H trunking.

PC /
ABS



End piece, trunking type WDKH 30045

| Type | Colour | Dim. a mm | Dim. b mm | Pack Piece | Weight kg/100 pc. | Item no. |
|----------------|------------|-----------------|-----------------|---------------|----------------------|----------|
| WDKH-E30045RW | Pure white | 45 | 30 | 10 | 0.435 | 6175554 |
| WDKH-E30045LGR | Light grey | 45 | 30 | 10 | 0.500 | 6175932 |

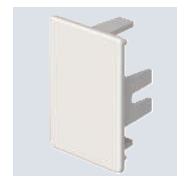
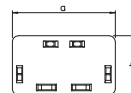

End piece for closing the WDK-H trunking.

Trunking, type WDKH 40060

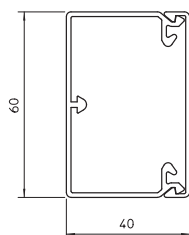

| Type | Colour | Length mm | Pack m | Weight kg/100 m | Item no. |
|------------------|------------|--------------|-----------|--------------------|----------|
| WDKH-40060RW | Pure white | 2000 | 32 | 44.000 | 6175410 |
| WDKH-40060LGR | Light grey | 2000 | 32 | 44.000 | 6175466 |
| WDKH40060RW 2500 | Pure white | 2000 | 1 | 11.000 | 6175412 |

Trunking cover and base with base perforation made of halogen-free plastic including cover fixing devices.

Internal corner cover, trunking type WDKH 40060

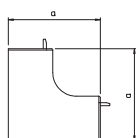
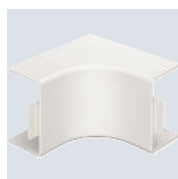

| Type | Colour | Dim. a mm | Pack Piece | Weight kg/100 pc. | Item no. |
|----------------|------------|-----------------|---------------|----------------------|----------|
| WDKH-I40060RW | Pure white | 85 | 2 | 6.427 | 6175594 |
| WDKH-I40060LGR | Light grey | 85 | 2 | 6.427 | 6175972 |

Internal corner cover for changing the direction of the halogen-free WDKH trunking.

External corner cover, trunking type WDKH 40060

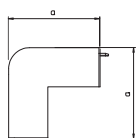

| Type | Colour | Dim. a mm | Pack Piece | Weight kg/100 pc. | Item no. |
|----------------|------------|-----------------|---------------|----------------------|----------|
| WDKH-A40060RW | Pure white | 45 | 2 | 7.423 | 6175630 |
| WDKH-A40060LGR | Light grey | 45 | 2 | 7.423 | 6176008 |

External corner cover for changing the direction of the halogen-free WDKH trunking.

Flat angle cover, trunking type WDKH 40060

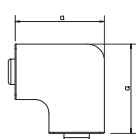

| Type | Colour | Dim. a mm | Pack Piece | Weight kg/100 pc. | Item no. |
|----------------|------------|-----------------|---------------|----------------------|----------|
| WDKH-F40060RW | Pure white | 85 | 2 | 7.048 | 6175666 |
| WDKH-F40060LGR | Light grey | 85 | 2 | 7.048 | 6176044 |

Flat angle hood for changing the direction of the halogen-free WDKH trunking.

T and intersection cover, for trunking type WDKH 40060

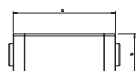

| Type | Colour | Dim. a mm | Dim. b mm | Pack Piece | Weight kg/100 pc. | Item no. |
|----------------|------------|-----------------|-----------------|---------------|----------------------|----------|
| WDKH-T40060RW | Pure white | 190 | 66 | 2 | 8.413 | 6175702 |
| WDKH-T40060LGR | Light grey | 190 | 66 | 2 | 8.413 | 6176080 |

T and intersection cover for changing the direction of the halogen-free WDKH trunking. The fitting is preperforated at the side for the connection of different trunking cross-sections.

PC /
ABS



End piece, trunking type WDKH 40060

| Type | Colour | Dim. a mm | Dim. b mm | Pack Piece | Weight kg/100 pc. | Item no. |
|----------------|------------|-----------------|-----------------|---------------|----------------------|----------|
| WDKH-E40060RW | Pure white | 40 | 60 | 10 | 0.992 | 6175558 |
| WDKH-E40060LGR | Light grey | 40 | 60 | 10 | 0.992 | 6175936 |

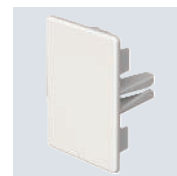
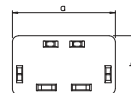

End piece for closing the WDK-H trunking.

Trunking, type WDKH 60090

PC/
ABS

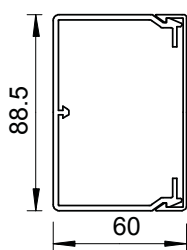
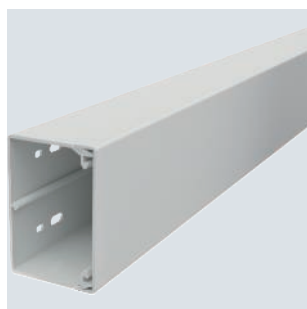

| Type | Colour | Length mm | Pack m | Weight kg/100 m | Item no. |
|------------------|------------|--------------|-----------|--------------------|----------|
| WDKH-60090RW | Pure white | 2000 | 24 | 81.500 | 6175415 |
| WDKH-60090LGR | Light grey | 2000 | 24 | 81.500 | 6175469 |
| WDKH60090RW 2500 | Pure white | 2000 | 1 | 203.750 | 6175417 |

Trunking cover and base with base perforation made of halogen-free plastic including cover fixing devices.

Internal corner cover, trunking type WDKH 60090

PC/
ABS

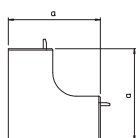
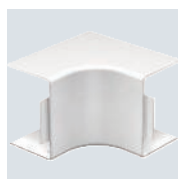

| Type | Colour | Dim. a mm | Pack Piece | Weight kg/100 pc. | Item no. |
|----------------|------------|-----------------|---------------|----------------------|----------|
| WDKH-I60090RW | Pure white | 130 | 2 | 11.123 | 6175598 |
| WDKH-I60090LGR | Light grey | 130 | 2 | 11.123 | 6175976 |

Internal corner cover for changing the direction of the halogen-free WDKH trunking.

External corner cover, trunking type WDKH 60090

PC/
ABS

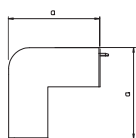

| Type | Colour | Dim. a mm | Pack Piece | Weight kg/100 pc. | Item no. |
|----------------|------------|-----------------|---------------|----------------------|----------|
| WDKH-A60090RW | Pure white | 69 | 2 | 10.373 | 6175634 |
| WDKH-A60090LGR | Light grey | 69 | 2 | 10.700 | 6176012 |

External corner cover for changing the direction of the halogen-free WDKH trunking.

Flat angle cover, trunking type WDKH 60090

PC/
ABS

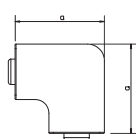

| Type | Colour | Dim. a mm | Pack Piece | Weight kg/100 pc. | Item no. |
|----------------|------------|-----------------|---------------|----------------------|----------|
| WDKH-F60090RW | Pure white | 129 | 2 | 9.696 | 6175670 |
| WDKH-F60090LGR | Light grey | 129 | 2 | 9.696 | 6176048 |

Flat angle hood for changing the direction of the halogen-free WDKH trunking.

T and intersection cover, for trunking type WDKH 60090

PC/
ABS

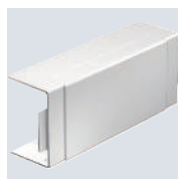

| Type | Colour | Dim. a mm | Pack Piece | Weight kg/100 pc. | Item no. |
|----------------|------------|-----------------|---------------|----------------------|----------|
| WDKH-T60090RW | Pure white | 230 | 2 | 21.500 | 6175706 |
| WDKH-T60090LGR | Light grey | 230 | 2 | 21.500 | 6176084 |

T and intersection cover for changing the direction of the halogen-free WDKH trunking. The fitting is preperforated at the side for the connection of different trunking cross-sections.

PC /
ABS



End piece, trunking type WDKH 60090

| Type | Colour | Dim. a mm | Dim. b mm | Pack Piece | Weight kg/100 pc. | Item no. |
|----------------|------------|-----------------|-----------------|---------------|----------------------|----------|
| WDKH-E60090RW | Pure white | 90 | 60 | 10 | 2.024 | 6175562 |
| WDKH-E60090LGR | Light grey | 90 | 60 | 10 | 2.024 | 6175940 |

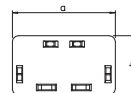

End piece for closing the WDK-H trunking.

Trunking, type WDKH 60110

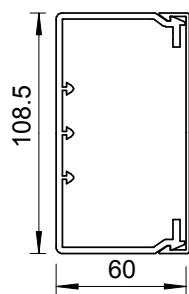

| Type | Colour | Length mm | Pack m | Weight kg/100 m | Item no. |
|---------------|------------|--------------|-----------|--------------------|----------|
| WDKH-60110RW | Pure white | 2000 | 16 | 95.900 | 6175420 |
| WDKH-60110LGR | Light grey | 2000 | 16 | 95.900 | 6175472 |

Trunking cover and base with base perforation made of halogen-free plastic including cover fixing devices.

Internal corner cover, trunking type WDKH 60110

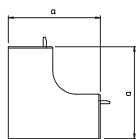
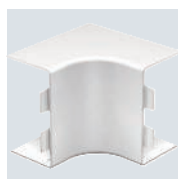

| Type | Colour | Dim. a mm | Pack Piece | Weight kg/100 pc. | Item no. |
|----------------|------------|-----------------|---------------|----------------------|----------|
| WDKH-I60110RW | Pure white | 130 | 2 | 11.315 | 6175602 |
| WDKH-I60110LGR | Light grey | 130 | 2 | 11.315 | 6175980 |

Internal corner cover for changing the direction of the halogen-free WDKH trunking.

External corner cover, trunking type WDKH 60110

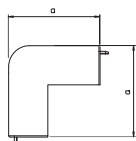

| Type | Colour | Dim. a mm | Pack Piece | Weight kg/100 pc. | Item no. |
|----------------|------------|-----------------|---------------|----------------------|----------|
| WDKH-A60110RW | Pure white | 100 | 2 | 11.437 | 6175638 |
| WDKH-A60110LGR | Light grey | 100 | 2 | 11.338 | 6176016 |

External corner cover for changing the direction of the halogen-free WDKH trunking.

Flat angle cover, trunking type WDKH 60110

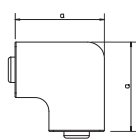

| Type | Colour | Dim. a mm | Pack Piece | Weight kg/100 pc. | Item no. |
|----------------|------------|-----------------|---------------|----------------------|----------|
| WDKH-F60110RW | Pure white | 149 | 2 | 12.984 | 6175674 |
| WDKH-F60110LGR | Light grey | 149 | 2 | 13.022 | 6176052 |

Flat angle hood for changing the direction of the halogen-free WDKH trunking.

T and intersection cover, for trunking type WDKH 60110

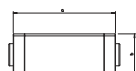
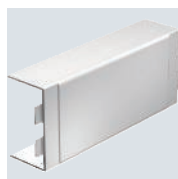

| Type | Colour | Dim. a mm | Dim. b mm | Pack Piece | Weight kg/100 pc. | Item no. |
|----------------|------------|-----------------|-----------------|---------------|----------------------|----------|
| WDKH-T60110RW | Pure white | 272 | 114 | 2 | 20.921 | 6175710 |
| WDKH-T60110LGR | Light grey | 272 | 114 | 2 | 20.921 | 6176088 |

T and intersection cover for changing the direction of the halogen-free WDKH trunking. The fitting is preperforated at the side for the connection of different trunking cross-sections.

PC /
ABS



End piece, trunking type WDKH 60110

| Type | Colour | Dim. | | Pack Piece | Weight kg/100 pc. | Item no. |
|----------------|------------|------|------|------------|-------------------|----------|
| | | a mm | b mm | | | |
| WDKH-E60110RW | Pure white | 110 | 60 | 10 | 2.556 | 6175566 |
| WDKH-E60110LGR | Light grey | 110 | 60 | 10 | 2.528 | 6175944 |

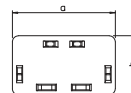

End piece for closing the WDK-H trunking.

Trunking, type WDKH 60150

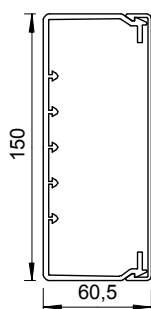

| Type | Colour | Length mm | Pack m | Weight kg/100 m | Item no. |
|---------------|------------|--------------|-----------|--------------------|----------|
| WDKH-60150RW | Pure white | 2000 | 8 | 146.650 | 6175425 |
| WDKH-60150LGR | Light grey | 2000 | 8 | 146.650 | 6175475 |

Trunking cover and base with base perforation made of halogen-free plastic including cover fixing devices.

Internal corner cover, trunking type WDKH 60150

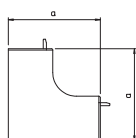

| Type | Colour | Dim. a mm | Pack Piece | Weight kg/100 pc. | Item no. |
|----------------|------------|-----------------|---------------|----------------------|----------|
| WDKH-I60150RW | Pure white | 130 | 2 | 12.521 | 6175606 |
| WDKH-I60150LGR | Light grey | 130 | 2 | 12.521 | 6175984 |

Internal corner cover for changing the direction of the halogen-free WDKH trunking.

External corner cover, trunking type WDKH 60150

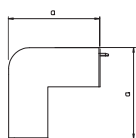

| Type | Colour | Dim. a mm | Pack Piece | Weight kg/100 pc. | Item no. |
|----------------|------------|-----------------|---------------|----------------------|----------|
| WDKH-A60150RW | Pure white | 100 | 2 | 15.180 | 6175642 |
| WDKH-A60150LGR | Light grey | 100 | 2 | 15.180 | 6176020 |

External corner cover for changing the direction of the halogen-free WDKH trunking.

Flat angle cover, trunking type WDKH 60150

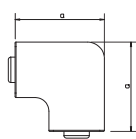

| Type | Colour | Dim. a mm | Pack Piece | Weight kg/100 pc. | Item no. |
|----------------|------------|-----------------|---------------|----------------------|----------|
| WDKH-F60150RW | Pure white | 190 | 2 | 18.643 | 6175678 |
| WDKH-F60150LGR | Light grey | 190 | 2 | 18.643 | 6176056 |

Flat angle hood for changing the direction of the halogen-free WDKH trunking.

T and intersection cover, for trunking type WDKH 60150



| Type | Colour | Dim. a mm | Dim. b mm | Pack Piece | Weight kg/100 pc. | Item no. |
|----------------|------------|-----------------|-----------------|---------------|----------------------|----------|
| WDKH-T60150RW | Pure white | 291 | 155 | 2 | 23.463 | 6175714 |
| WDKH-T60150LGR | Light grey | 291 | 155 | 2 | 23.463 | 6176092 |

T and intersection cover for changing the direction of the halogen-free WDKH trunking. The fitting is preperforated at the side for the connection of different trunking cross-sections.

PC / ABS



End piece, trunking type WDKH 60150

| Type | Colour | Dim. a mm | Dim. b mm | Pack Piece | Weight kg/100 pc. | Item no. |
|----------------|------------|-----------|-----------|------------|-------------------|----------|
| WDKH-E60150RW | Pure white | 150 | 60 | 10 | 3.613 | 6175570 |
| WDKH-E60150LGR | Light grey | 150 | 60 | 10 | 3.736 | 6175948 |

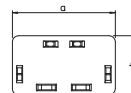

End piece for closing the WDK-H trunking.

Partition, halogen-free, for trunking height 40 mm

PC/
ABS

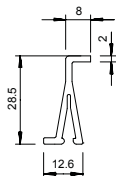

| Type | Colour | Length mm | Pack m | Weight kg/100 m | Item no. |
|--------------|------------|--------------|-----------|--------------------|----------|
| WDKH-TW40LGR | Light grey | 2000 | 2 | 13.350 | 6175500 |

Partition to divide the WDKH trunking of 40 mm trunking height for the installation of different voltage levels.

Partition, halogen-free, for trunking height 60 mm

PC/
ABS

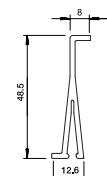

| Type | Colour | Length mm | Pack m | Weight kg/100 m | Item no. |
|--------------|------------|--------------|-----------|--------------------|----------|
| WDKH-TW60LGR | Light grey | 2000 | 2 | 20.650 | 6175504 |

Partition to divide the WDKH trunking of 60 mm trunking height for the installation of different voltage levels.

Cover clips

Cover clip for WDKH trunking, trunking width 60 mm

PC/
ABS

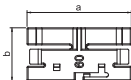
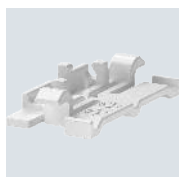

| Type | Colour | Dim. a mm | Dim. b mm | Pack Piece | Weight kg/100 pc. | Item no. |
|---------|------------|-----------------|-----------------|---------------|----------------------|----------|
| OTK H60 | Pure white | 48.8 | 24.8 | 10 | 0.400 | 6176122 |

Cover clip for better and easier laying of lines in the WDKH trunking.

Cover clip for WDKH trunking, trunking width 90 mm

PC/
ABS

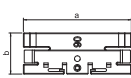
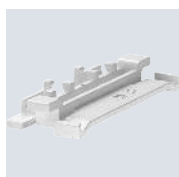

| Type | Colour | Dim. a mm | Dim. b mm | Pack Piece | Weight kg/100 pc. | Item no. |
|---------|------------|-----------------|-----------------|---------------|----------------------|----------|
| OTK H90 | Pure white | 75.7 | 28.8 | 10 | 0.900 | 6176125 |

Cover clip for better and easier laying of lines in the WDKH trunking.

Cover clip for WDKH trunking, trunking width 110 mm

PC/
ABS

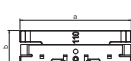
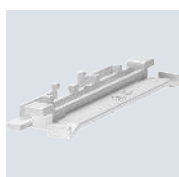

| Type | Colour | Dim. a mm | Dim. b mm | Pack Piece | Weight kg/100 pc. | Item no. |
|----------|------------|-----------------|-----------------|---------------|----------------------|----------|
| OTK H110 | Pure white | 95.7 | 28.8 | 10 | 1.200 | 6176128 |

Cover clip for better and easier laying of lines in the WDKH trunking.

PC / ABS



Cover clip for WDKH trunking, trunking width 150 mm

| Type | Colour | Dim. | | Pack Piece | Weight kg/100 pc. | Item no. |
|----------|------------|-------|------|------------|-------------------|----------|
| | | a mm | b mm | | | |
| OTK H150 | Pure white | 136.2 | 36 | 10 | 2.050 | 6176131 |

Cover clip for better and easier laying of lines in the WDKH trunking.

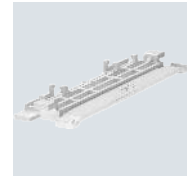

PVC



Cover clip for WDK trunking, trunking width 60 mm

| Type | Colour | Dim. | | Pack Piece | Weight kg/100 pc. | Item no. |
|---------|------------|------|------|------------|-------------------|----------|
| | | a mm | b mm | | | |
| 2370 60 | Light grey | 48.8 | 24.8 | 20 | 0.500 | 6022995 |

Cover clip for better and easier laying of lines in the WDK trunking.

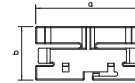

PVC



Cover clip for WDK trunking, trunking width 90 mm

| Type | Colour | Dim. | | Pack Piece | Weight kg/100 pc. | Item no. |
|---------|------------|------|------|------------|-------------------|----------|
| | | a mm | b mm | | | |
| 2370 90 | Light grey | 75.7 | 28.8 | 20 | 1.100 | 6023509 |

Cover clip for better and easier laying of lines in the WDK trunking.

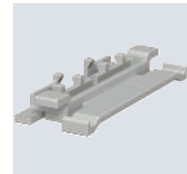
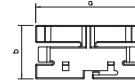

PVC



Cover clip for WDK trunking, trunking width 110 mm

| Type | Colour | Dim. | | Pack Piece | Weight kg/100 pc. | Item no. |
|----------|------------|------|------|------------|-------------------|----------|
| | | a mm | b mm | | | |
| 2370 110 | Light grey | 95.7 | 28.8 | 20 | 1.400 | 6023517 |

Cover clip for better and easier laying of lines in the WDK trunking.

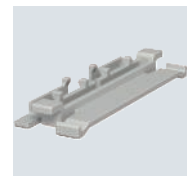

PVC



Cover clip for WDK trunking, trunking width 130 mm

| Type | Colour | Dim. | | Pack Piece | Weight kg/100 pc. | Item no. |
|----------|------------|-------|------|------------|-------------------|----------|
| | | a mm | b mm | | | |
| 2370 130 | Light grey | 116.2 | 36 | 20 | 2.500 | 6023525 |

Cover clip for better and easier laying of lines in the WDK trunking.

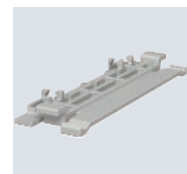

Cover clip for WDK trunking, trunking width 150 mm

PVC

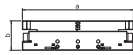

| Type | Colour | Dim. | | Pack Piece | Weight kg/100 pc. | Item no. |
|----------|------------|-------|------|------------|-------------------|----------|
| | | a mm | b mm | | | |
| 2370 150 | Light grey | 136.2 | 36 | 20 | 2.050 | 6023533 |

Cover clip for better and easier laying of lines in the WDK trunking.

Cover clip for WDK trunking, trunking width 170 mm

PVC

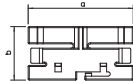
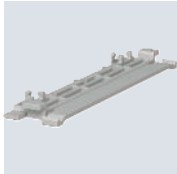

| Type | Colour | Dim. | | Pack Piece | Weight kg/100 pc. | Item no. |
|----------|------------|-------|------|------------|-------------------|----------|
| | | a mm | b mm | | | |
| 2370 170 | Light grey | 156.7 | 36 | 20 | 3.300 | 6023541 |

Cover clip for better and easier laying of lines in the WDK trunking.

Cover clip for WDK trunking, trunking width 210 mm

PVC



| Type | Colour | Dim. | | Pack Piece | Weight kg/100 pc. | Item no. |
|----------|------------|-------|------|------------|-------------------|----------|
| | | a mm | b mm | | | |
| 2370 210 | Light grey | 197.2 | 36 | 20 | 3.900 | 6023576 |

Cover clip for better and easier laying of lines in the WDK trunking.

Cover clip for WDK trunking, trunking width 230 mm

PVC

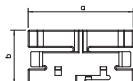







| Type | Colour | Dim. | | Pack Piece | Weight kg/100 pc. | Item no. |
|----------|------------|-------|------|------------|-------------------|----------|
| | | a mm | b mm | | | |
| 2370 230 | Light grey | 216.2 | 36 | 20 | 4.800 | 6023584 |

Cover clip for better and easier laying of lines in the WDK trunking.





Metal cable routing trunking

| | | |
|--|---|-----|
|  | Nominal height 20 | 144 |
|  | Nominal height 30 | 150 |
|  | Nominal height 40 | 152 |
|  | Nominal height 60 | 156 |
|  | Nominal height 80 | 164 |
|  | Accessories, metal cable routing trunking | 166 |



System description



LKM metal cable routing trunking has two areas of application. The stable system for the routing and protection of cables is used in the field of machines and systems. The completed system allows simple installation at a later date, also with pre-terminated connectors, offering reliable protection against mechanical loads and

soiling. The LKM cable routing trunking of type LKM 20030 and 60100 are also tested as a cable-specific routing type for the maintenance of electrical function according to DIN 4102 Part 12.

Installation principle

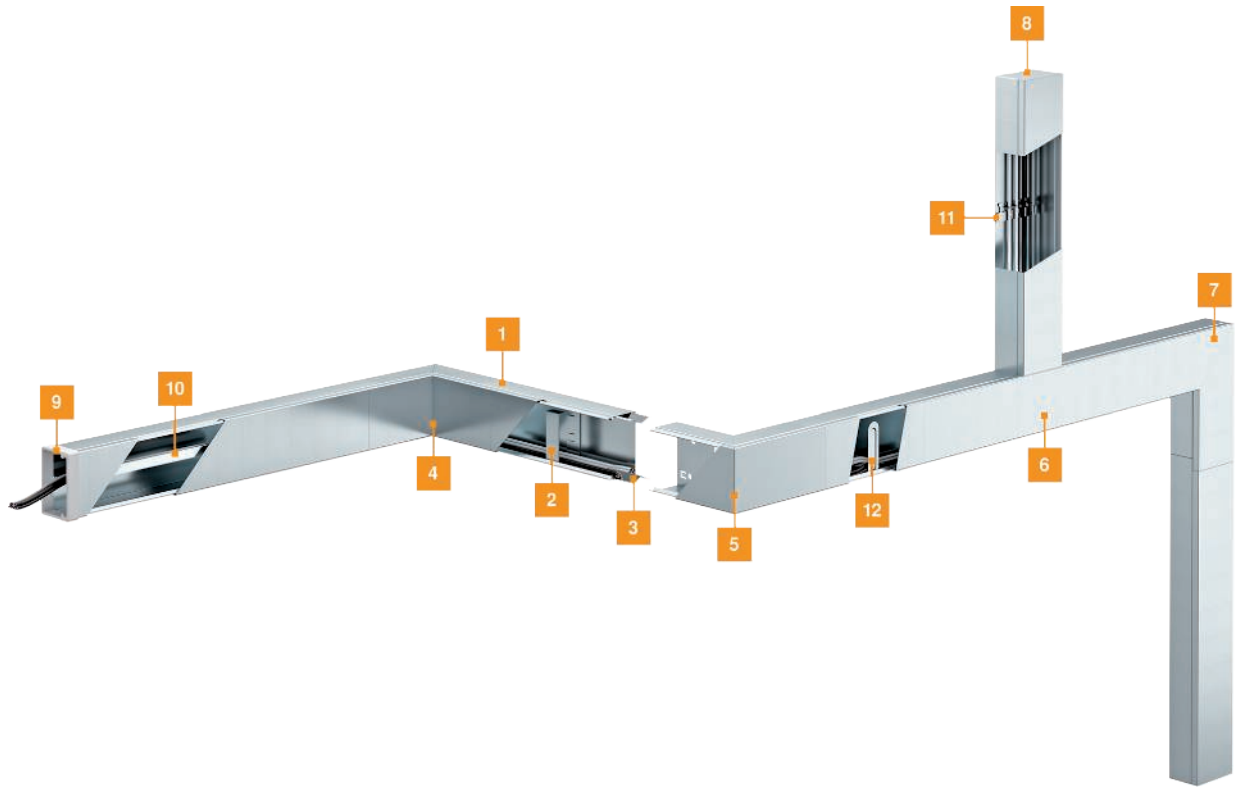

| | |
|----|---|
| 1 | Trunking |
| 2 | Duct clamp for the maintenance of electrical function |
| 3 | Joint connector |
| 4 | Internal corner |
| 5 | External corner |
| 6 | T piece |
| 7 | Flat angle |
| 8 | End piece |
| 9 | Edge protection ring |
| 10 | Partition |
| 11 | Cable brackets |
| 12 | Duct clamp |



Mounting aid



Machines application area

In the area of machines, the LKM metal cable trunking is used to provide additional protection for the cables.



Corridor, stairwell application area

The stable LKM metal cable trunking can be used anywhere, in which cables require mechanical protection.



Machine trunking mounting

Screw the LKM metal cable trunking to the machine, for example, using cylinder head bolts of type 341.



Wall trunking mounting

Knock-in anchors of type 910/SD can be used to fasten the LKM trunking directly on the wall.



Installation of internal corner

As with the LKM trunking, the fittings are mounted at the appropriate points.



Installation of joint connectors

After installing the LKM trunking, lock the joint connector into the parts to be connected from inside. This guarantees the equipotential bonding between these two parts.



Installation of partition

Insert the partition into the straps located on the floor. This guarantees equipotential bonding without any additional aids.



Installation of cable fixing holder

The cable bracket is mounted using the trunking fastening screw. The cables can be held using cable ties, type 565.



Installation of duct clamp

The duct clamp is placed on the loop perforation in the base and then locked into the cover contour. If a partition wall is also installed, the partition wall must be separated into sections.



Equipotential bonding

Equipotential bonding is guaranteed between the cover and the base through the special cover contour. The LKM trunking is earthed using the connection strap located in the base.



Installation of edge protection ring

Place the edge protection ring on the open ends of the LKM trunking. It prevents damage to the cables within.

St FS FSK



Cable trunking, type LKM 20020

| Type | Colour | Length mm | Pack m | Weight kg/100 m | Item no. |
|------------|------------|--------------|-----------|--------------------|----------|
| LKM20020FS | — | 2000 | 2 | 46.000 | 6246966 |
| LKM20020RW | Pure white | 2000 | 2 | 52.000 | 6248462 |

Trunking cover and base with base perforation.
Equipotential bonding is guaranteed between the cover and the base without any additional aids.

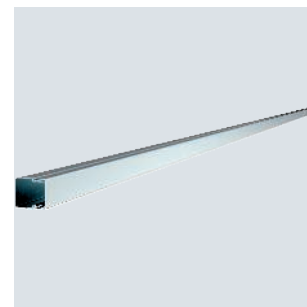
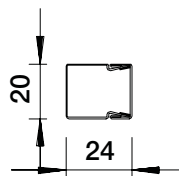

VA 2B



Joint connector LKM SV20

| Type | Dim. a mm | Dim. b mm | Pack Piece | Weight kg/100 pc. | Item no. |
|----------|-----------------|-----------------|---------------|----------------------|----------|
| LKM SV20 | 45 | 20 | 10 | 0.190 | 6247431 |

Joint connector to connect the bases. This creates the equipotential bonding between the trunking bases.

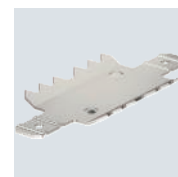
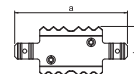

PVC



Edge protection ring KSR 20020, for LKM cable trunking type 20020

| Type | Colour | Dim. a mm | Dim. b mm | Pack Piece | Weight kg/100 pc. | Item no. |
|----------|--------|-----------------|-----------------|---------------|----------------------|----------|
| KSR20020 | Grey | 24 | 28 | 5 | 0.900 | 6249842 |

Edge protection ring for the open ends of LKM cable trunking.

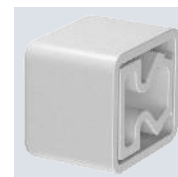
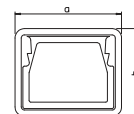

Cable trunking, type LKM 20030

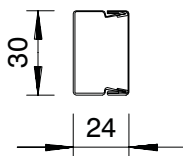
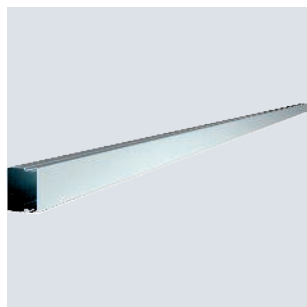

| Type | Colour | Length mm | Pack m | Weight kg/100 m | Item no. |
|------------|------------|--------------|-----------|--------------------|----------|
| LKM20030FS | — | 2000 | 2 | 58.000 | 6246974 |
| LKM20030RW | Pure white | 2000 | 2 | 58.000 | 6248470 |

Duct cover and base with base perforation. Equipotential bonding is guaranteed between the cover and the base without any additional aids. The LKM cable duct, type LKM 20030, has been tested for the maintenance of electrical function as a routing system according to DIN 4102 Part 12. Please note the cable types tested in the BSS fire protection systems division!

Joint connector LKM SV30

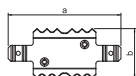
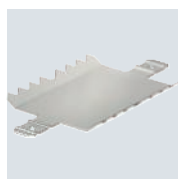

| Type | Dim. a mm | Dim. b mm | Pack Piece | Weight kg/100 pc. | Item no. |
|----------|-----------------|-----------------|---------------|----------------------|----------|
| LKM SV30 | 54 | 30 | 10 | 0.400 | 6247434 |

Joint connector to connect the bases. This creates the equipotential bonding between the duct bases.

Edge protection ring KSR 20030, for LKM cable duct type 20030

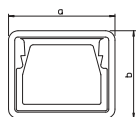

| Type | Colour | Dim. a mm | Dim. b mm | Pack Piece | Weight kg/100 pc. | Item no. |
|----------|--------|-----------------|-----------------|---------------|----------------------|----------|
| KSR20030 | Grey | 34 | 28 | 5 | 1.100 | 6249844 |

Edge protection ring for the open ends of LKM cable trunking.



Cable trunking, type LKM 30030

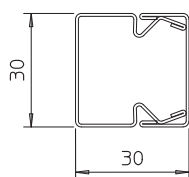

| Type | Colour | Length mm | Pack m | Weight kg/100 m | Item no. |
|------------|------------|--------------|-----------|--------------------|----------|
| LKM30030FS | — | 2000 | 2 | 62.000 | 6246985 |
| LKM30030RW | Pure white | 2000 | 2 | 62.000 | 6248489 |

Trunking cover and base with base perforation.
Equipotential bonding is guaranteed between the cover and the base without any additional aids.

Joint connector LKM SV30

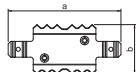
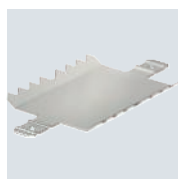

| Type | Dim. a mm | Dim. b mm | Pack Piece | Weight kg/100 pc. | Item no. |
|----------|-----------------|-----------------|---------------|----------------------|----------|
| LKM SV30 | 54 | 30 | 10 | 0.400 | 6247434 |

Joint connector to connect the bases. This creates the equipotential bonding between the duct bases.

End piece, for cable trunking type LKM 30030

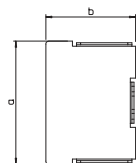
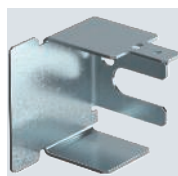

| Type | Colour | Dim. a mm | Dim. b mm | Pack Piece | Weight kg/100 pc. | Item no. |
|--------------|------------|-----------------|-----------------|---------------|----------------------|----------|
| LKM E30030FS | — | 30 | 30 | 10 | 1.000 | 6247876 |
| LKM E30030RW | Pure white | 30 | 30 | 10 | 1.000 | 6249410 |

End piece for closing the LKM ducts.

Edge protection ring KSR 30030, for LKM cable trunking 30030

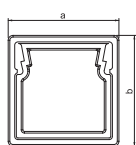

| Type | Colour | Dim. a mm | Dim. b mm | Pack Piece | Weight kg/100 pc. | Item no. |
|----------|--------|-----------------|-----------------|---------------|----------------------|----------|
| KSR30030 | Grey | 34 | 34 | 5 | 1.300 | 6249847 |

Edge protection ring for the open ends of LKM cable trunking.



Cable trunking, type LKM 40040

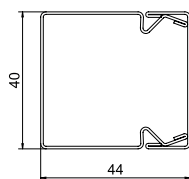
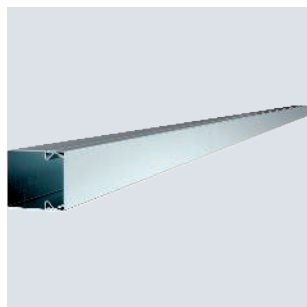

| Type | Colour | Length mm | Pack m | Weight kg/100 m | Item no. |
|------------|------------|--------------|-----------|--------------------|----------|
| LKM40040FS | — | 2000 | 2 | 117.000 | 6246990 |
| LKM40040RW | Pure white | 2000 | 2 | 127.600 | 6248497 |

Trunking cover and base with base perforation.
Equipotential bonding is guaranteed between the cover and the base without any additional aids.

Joint connector LKM SV40

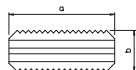

| Type | Dim. a mm | Dim. b mm | Pack Piece | Weight kg/100 pc. | Item no. |
|----------|-----------------|-----------------|---------------|----------------------|----------|
| LKM SV40 | 76 | 30 | 10 | 1.000 | 6247458 |

Joint connector to connect the bases. This creates the equipotential bonding between the duct bases.

Internal corner, for cable trunking type LKM 40040

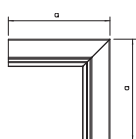
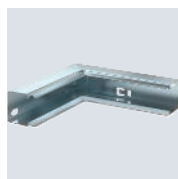

| Type | Colour | Dim. a mm | Pack Piece | Weight kg/100 pc. | Item no. |
|--------------|------------|-----------------|---------------|----------------------|----------|
| LKM I40040FS | — | 160 | 1 | 28.000 | 6247652 |
| LKM I40040RW | Pure white | 160 | 1 | 28.000 | 6249167 |

Internal corner for changing the direction of the LKM trunking.

External corner, for cable trunking ducts type LKM 40040

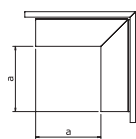

| Type | Colour | Dim. a mm | Pack Piece | Weight kg/100 pc. | Item no. |
|--------------|------------|-----------------|---------------|----------------------|----------|
| LKM A40040FS | — | 120 | 1 | 38.600 | 6247563 |
| LKM A40040RW | Pure white | 120 | 1 | 38.600 | 6249086 |

External corner including cover for changing the direction of the LKM trunking.

T piece, for cable trunking type LKM 40040

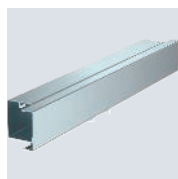

| Type | Colour | Dim. a mm | Pack Piece | Weight kg/100 pc. | Item no. |
|--------------|------------|-----------------|---------------|----------------------|----------|
| LKM T40040FS | — | 300 | 1 | 39.700 | 6247725 |
| LKM T40040RW | Pure white | 300 | 1 | 39.700 | 6249256 |

T piece including cover for changing the direction of the LKM ducts.

St FS FSK



Flat angle, for cable trunking type LKM 40040

| Type | Colour | Dim. a mm | Pack Piece | Weight kg/100 pc. | Item no. |
|--------------|------------|-----------|------------|-------------------|----------|
| LKM F40040FS | — | 140 | 1 | 37.100 | 6247490 |
| LKM F40040RW | Pure white | 140 | 1 | 37.100 | 6248993 |

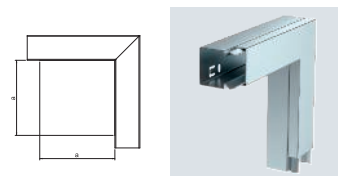

Flat angle including cover for changing the direction of the LKM ducts.

St FS FSK



End piece, for cable trunking type LKM 40040

| Type | Colour | Dim. a mm | Dim. b mm | Pack Piece | Weight kg/100 pc. | Item no. |
|--------------|------------|-----------|-----------|------------|-------------------|----------|
| LKM E40040FS | — | 40 | 44 | 10 | 2.500 | 6247881 |
| LKM E40040RW | Pure white | 40 | 44 | 10 | 2.500 | 6249418 |

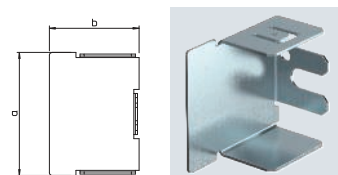

End piece for closing the LKM ducts.

PVC



Edge protection ring KSR 40040, for LKM cable trunking type 40040

| Type | Colour | Dim. a mm | Dim. b mm | Pack Piece | Weight kg/100 pc. | Item no. |
|----------|--------|-----------|-----------|------------|-------------------|----------|
| KSR40040 | Grey | 44 | 48 | 5 | 1.800 | 6249846 |

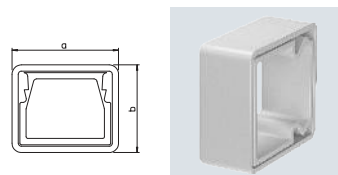

Edge protection ring for the open ends of LKM cable trunking.

Cable trunking, type LKM 40060

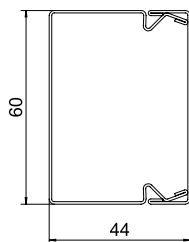

| Type | Colour | Length mm | Pack m | Weight kg/100 m | Item no. |
|------------|------------|--------------|-----------|--------------------|----------|
| LKM40060FS | – | 2000 | 2 | 151.200 | 6247016 |
| LKM40060RW | Pure white | 2000 | 2 | 151.200 | 6248519 |

Trunking cover and base with base perforation.
Equipotential bonding is guaranteed between the cover and the base without any additional aids.

Joint connector LKM SV40

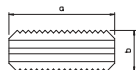

| Type | Dim. a mm | Dim. b mm | Pack Piece | Weight kg/100 pc. | Item no. |
|----------|-----------------|-----------------|---------------|----------------------|----------|
| LKM SV40 | 76 | 30 | 10 | 1.000 | 6247458 |

Joint connector to connect the bases. This creates the equipotential bonding between the duct bases.

Internal corner, for cable trunking type LKM 40060

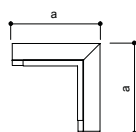
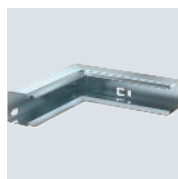

| Type | Colour | Dim. a mm | Pack Piece | Weight kg/100 pc. | Item no. |
|--------------|------------|-----------------|---------------|----------------------|----------|
| LKM I40060FS | – | 160 | 1 | 31.400 | 6247660 |
| LKM I40060RW | Pure white | 160 | 1 | 31.400 | 6249175 |

Internal corner for changing the direction of LKM ducts.

External corner, for cable routing trunking type LKM 40060

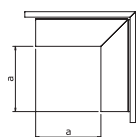
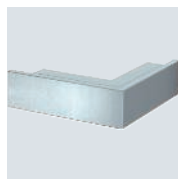

| Type | Colour | Dim. a mm | Pack Piece | Weight kg/100 pc. | Item no. |
|--------------|------------|-----------------|---------------|----------------------|----------|
| LKM A40060FS | – | 120 | 1 | 46.300 | 6247571 |
| LKM A40060RW | Pure white | 120 | 1 | 46.300 | 6249094 |

External corner including cover for changing the direction of the LKM ducts.

T piece, for cable trunking type LKM 40060

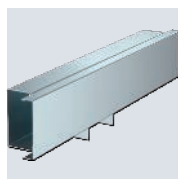

| Type | Colour | Dim. a mm | Pack Piece | Weight kg/100 pc. | Item no. |
|--------------|------------|-----------------|---------------|----------------------|----------|
| LKM T40060FS | – | 300 | 1 | 46.800 | 6247733 |
| LKM T40060RW | Pure white | 300 | 1 | 46.800 | 6249264 |

T piece including cover for changing the direction of the LKM ducts.

St FS FSK



Flat angle, for cable trunking type LKM 40060

| Type | Colour | Dim. a mm | Pack Piece | Weight kg/100 pc. | Item no. |
|--------------|------------|-----------|------------|-------------------|----------|
| LKM F40060FS | — | 140 | 1 | 47.400 | 6247504 |
| LKM F40060RW | Pure white | 140 | 1 | 47.400 | 6249000 |

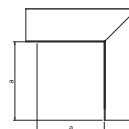

Flat angle including cover for changing the direction of the LKM ducts.

St FS FSK



End piece, for cable trunking type LKM 40060

| Type | Colour | Dim. a mm | Dim. b mm | Pack Piece | Weight kg/100 pc. | Item no. |
|--------------|------------|-----------|-----------|------------|-------------------|----------|
| LKM E40060FS | — | 60 | 44 | 10 | 3.000 | 6247903 |
| LKM E40060RW | Pure white | 60 | 44 | 10 | 3.000 | 6249426 |

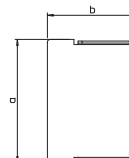

End piece for closing the LKM ducts.

PVC



Edge protection ring KSR 40060, for LKM cable trunking type 40060

| Type | Colour | Dim. a mm | Dim. b mm | Pack Piece | Weight kg/100 pc. | Item no. |
|----------|--------|-----------|-----------|------------|-------------------|----------|
| KSR40060 | Grey | 64 | 48 | 5 | 2.300 | 6249848 |

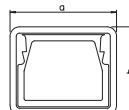

Edge protection ring for the open ends of LKM cable trunking.



Cable trunking, type LKM 60060

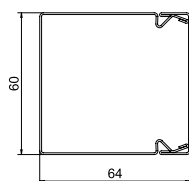
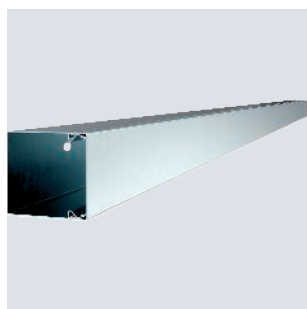

| Type | Colour | Length mm | Pack m | Weight kg/100 m | Item no. |
|------------|------------|--------------|-----------|--------------------|----------|
| LKM60060FS | — | 2000 | 2 | 174.700 | 6247091 |
| LKM60060RW | Pure white | 2000 | 2 | 174.700 | 6248608 |

Trunking cover and base with base perforation.
Equipotential bonding is guaranteed between the cover and the base without any additional aids. Note: LKM 60060 has no loop perforation in the base, a partition cannot be installed.

Joint connector LKM SV60

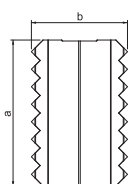

| Type | Dim. a mm | Dim. b mm | Pack Piece | Weight kg/100 pc. | Item no. |
|----------|-----------------|-----------------|---------------|----------------------|----------|
| LKM SV60 | 75 | 49 | 10 | 1.600 | 6247466 |

Joint connector to connect the bases. This creates the equipotential bonding between the duct bases.

Internal corner, for cable trunking type LKM 60060

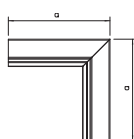
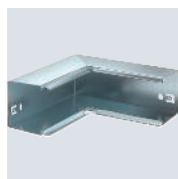

| Type | Colour | Dim. a mm | Pack Piece | Weight kg/100 pc. | Item no. |
|--------------|------------|-----------------|---------------|----------------------|----------|
| LKM I60060FS | — | 160 | 1 | 31.900 | 6248128 |
| LKM I60060RW | Pure white | 160 | 1 | 31.900 | 6249612 |

Internal corner for changing the direction of the LKM trunking.

External corner, for cable trunking type LKM 60060

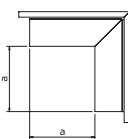
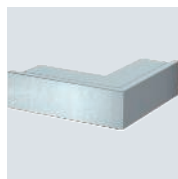

| Type | Colour | Dim. a mm | Pack Piece | Weight kg/100 pc. | Item no. |
|--------------|------------|-----------------|---------------|----------------------|----------|
| LKM A60060FS | — | 120 | 1 | 55.800 | 6248047 |
| LKM A60060RW | Pure white | 120 | 1 | 55.800 | 6249558 |

External corner including cover for changing the direction of the LKM ducts.

T piece, for cable trunking type LKM 60060

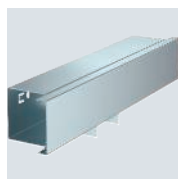

| Type | Colour | Dim. a mm | Pack Piece | Weight kg/100 pc. | Item no. |
|--------------|------------|-----------------|---------------|----------------------|----------|
| LKM T60060FS | — | 300 | 1 | 54.200 | 6248187 |
| LKM T60060RW | Pure white | 300 | 1 | 54.200 | 6249671 |

T piece including cover for changing the direction of the LKM trunking.

St FS FSK



Flat angle, for cable trunking type LKM 60060

| Type | Colour | Dim. a mm | Dim. b mm | Pack Piece | Weight kg/100 pc. | Item no. |
|--------------|------------|-----------|-----------|------------|-------------------|----------|
| LKM F60060FS | — | 140 | | 1 | 54.700 | 6247989 |
| LKM F60060RW | Pure white | 140 | | 1 | 54.700 | 6249485 |

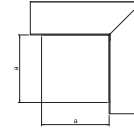

Flat angle including cover for changing the direction of the LKM ducts.

St FS FSK



End piece, for cable trunking type LKM 60060

| Type | Colour | Dim. a mm | Dim. b mm | Pack Piece | Weight kg/100 pc. | Item no. |
|--------------|------------|-----------|-----------|------------|-------------------|----------|
| LKM E60060FS | — | 60 | 64 | 10 | 4.500 | 6248284 |
| LKM E60060RW | Pure white | 60 | 64 | 10 | 4.500 | 6249795 |

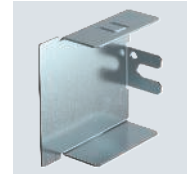
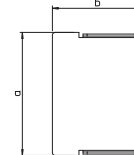

End piece for closing the LKM ducts.

PVC



Edge protection ring KSR60060, for LKM cable trunking type 60060

| Type | Colour | Dim. a mm | Dim. b mm | Pack Piece | Weight kg/100 pc. | Item no. |
|----------|--------|-----------|-----------|------------|-------------------|----------|
| KSR60060 | Grey | 64 | 68 | 5 | 2.400 | 6249850 |

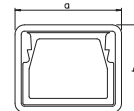

Edge protection ring for the open ends of LKM cable trunking.

Cable duct, type LKM 60100

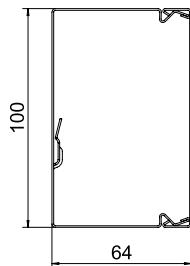
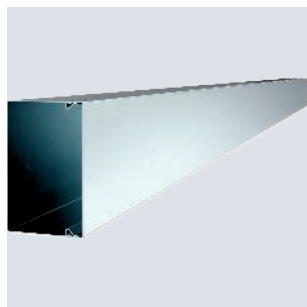

| Type | Colour | Length mm | Pack m | Weight kg/100 m | Item no. |
|------------|------------|--------------|-----------|--------------------|----------|
| LKM60100FS | – | 2000 | 2 | 221.700 | 6247113 |
| LKM60100RW | Pure white | 2000 | 2 | 221.700 | 6248624 |

Duct cover and base with base perforation. Equipotential bonding is guaranteed between the cover and the base without any additional aids. The LKM cable duct, type LKM 60100, has been tested for the maintenance of electrical function as a routing system according to DIN 4102 Part 12. Please note the cable types tested in the BSS fire protection systems division!

Joint connector LKM SV60

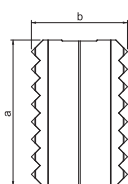

| Type | Dim. a mm | Dim. b mm | Pack Piece | Weight kg/100 pc. | Item no. |
|----------|-----------------|-----------------|---------------|----------------------|----------|
| LKM SV60 | 75 | 49 | 10 | 1.600 | 6247466 |

Joint connector to connect the bases. This creates the equipotential bonding between the duct bases.

Internal corner, for cable trunking type LKM 60100

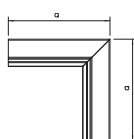
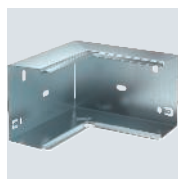

| Type | Colour | Dim. a mm | Pack Piece | Weight kg/100 pc. | Item no. |
|--------------|------------|-----------------|---------------|----------------------|----------|
| LKM I60100FS | – | 160 | 1 | 39.400 | 6248144 |
| LKM I60100RW | Pure white | 160 | 1 | 39.400 | 6249639 |

Internal corner for changing the direction of the LKM trunking.

External corner, for cable trunking type LKM 60100

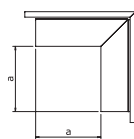
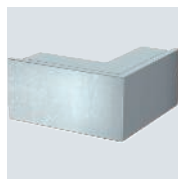

| Type | Colour | Dim. a mm | Pack Piece | Weight kg/100 pc. | Item no. |
|--------------|------------|-----------------|---------------|----------------------|----------|
| LKM A60100FS | – | 120 | 1 | 73.100 | 6248063 |
| LKM A60100RW | Pure white | 120 | 1 | 73.100 | 6249574 |

External corner including cover for changing the direction of the LKM ducts.

T piece for cable trunking type LKM 60100

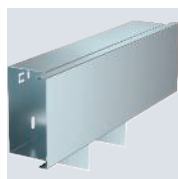

| Type | Colour | Dim. a mm | Pack Piece | Weight kg/100 pc. | Item no. |
|--------------|------------|-----------------|---------------|----------------------|----------|
| LKM T60100FS | – | 300 | 1 | 69.200 | 6248209 |
| LKM T60100RW | Pure white | 300 | 1 | 69.200 | 6249701 |

T piece including cover for changing the direction of the LKM ducts.

St FS FSK



Flat angle, for cable trunking type LKM 60100

| Type | Colour | Dim. a mm | Pack Piece | Weight kg/100 pc. | Item no. |
|--------------|------------|-----------|------------|-------------------|----------|
| LKM F60100FS | — | 140 | 1 | 63.400 | 6248004 |
| LKM F60100RW | Pure white | 140 | 1 | 63.400 | 6249507 |

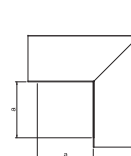

Flat angle including cover for changing the direction of the LKM ducts.

St FS FSK



End piece, for cable trunking type LKM 60100

| Type | Colour | Dim. a mm | Dim. b mm | Pack Piece | Weight kg/100 pc. | Item no. |
|--------------|------------|-----------|-----------|------------|-------------------|----------|
| LKM E60100FS | — | 100 | 64 | 10 | 6.200 | 6248306 |
| LKM E60100RW | Pure white | 100 | 64 | 10 | 6.500 | 6249817 |

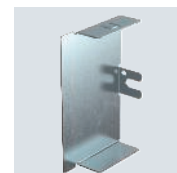
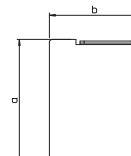

End piece for closing the LKM ducts.

PVC



Edge protection ring KSR60100, for LKM cable duct type 60100

| Type | Colour | Dim. a mm | Dim. b mm | Pack Piece | Weight kg/100 pc. | Item no. |
|----------|--------|-----------|-----------|------------|-------------------|----------|
| KSR60100 | Grey | 104 | 68 | 5 | 3.400 | 6249852 |

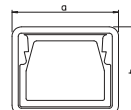

Edge protection ring for the open ends of LKM cable trunking.



Cable trunking, type LKM 60150

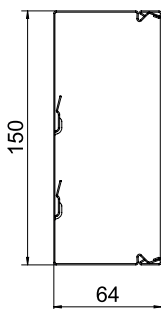

| Type | Colour | Length mm | Pack m | Weight kg/100 m | Item no. |
|------------|------------|--------------|-----------|--------------------|----------|
| LKM60150FS | — | 2000 | 2 | 280.100 | 6247148 |
| LKM60150RW | Pure white | 2000 | 2 | 280.100 | 6248640 |

Trunking cover and base with base perforation.
Equipotential bonding is guaranteed between the cover and the base without any additional aids.

Joint connector LKM SV60

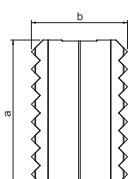

| Type | Dim. a mm | Dim. b mm | Pack Piece | Weight kg/100 pc. | Item no. |
|----------|-----------------|-----------------|---------------|----------------------|----------|
| LKM SV60 | 75 | 49 | 10 | 1.600 | 6247466 |

Joint connector to connect the bases. This creates the equipotential bonding between the duct bases.

Internal corner, for cable trunking type LKM 60150

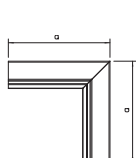
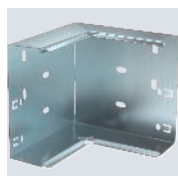

| Type | Colour | Dim. a mm | Pack Piece | Weight kg/100 pc. | Item no. |
|--------------|------------|-----------------|---------------|----------------------|----------|
| LKM I60150FS | — | 160 | 1 | 48.400 | 6248152 |
| LKM I60150RW | Pure white | 160 | 1 | 48.400 | 6249647 |

Internal corner for changing the direction of the LKM trunking.

External corner, for cable trunking type LKM 60150

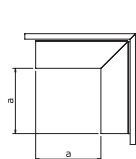
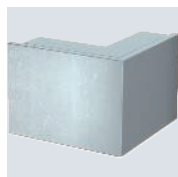

| Type | Colour | Dim. a mm | Pack Piece | Weight kg/100 pc. | Item no. |
|--------------|------------|-----------------|---------------|----------------------|----------|
| LKM A60150FS | — | 120 | 1 | 91.300 | 6248071 |
| LKM A60150RW | Pure white | 120 | 1 | 91.300 | 6249582 |

External corner including cover for changing the direction of the LKM ducts.

T piece, for cable trunking type LKM 60150

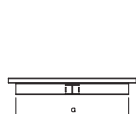

| Type | Colour | Dim. a mm | Pack Piece | Weight kg/100 pc. | Item no. |
|--------------|------------|-----------------|---------------|----------------------|----------|
| LKM T60150FS | — | 300 | 1 | 87.600 | 6248217 |
| LKM T60150RW | Pure white | 300 | 1 | 87.600 | 6249728 |

T piece including cover for changing the direction of the LKM ducts.

St FS FSK



Flat angle, for cable trunking type LKM 60150

| Type | Colour | Dim. a mm | Pack Piece | Weight kg/100 pc. | Item no. |
|--------------|------------|-----------|------------|-------------------|----------|
| LKM F60150FS | — | 140 | 1 | 113.500 | 6248012 |
| LKM F60150RW | Pure white | 140 | 1 | 113.500 | 6249515 |

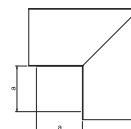

Flat angle including cover for changing the direction of the LKM ducts.

St FS FSK



End piece, for cable trunking type LKM 60150

| Type | Colour | Dim. a mm | Dim. b mm | Pack Piece | Weight kg/100 pc. | Item no. |
|--------------|------------|-----------|-----------|------------|-------------------|----------|
| LKM E60150FS | — | 150 | 64 | 10 | 8.400 | 6248314 |
| LKM E60150RW | Pure white | 150 | 64 | 10 | 9.000 | 6249825 |

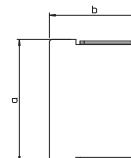

End piece for closing the LKM ducts.

PVC



Edge protection ring KSR60150, for LKM cable trunking type 60150

| Type | Colour | Dim. a mm | Dim. b mm | Pack Piece | Weight kg/100 pc. | Item no. |
|----------|--------|-----------|-----------|------------|-------------------|----------|
| KSR60150 | Grey | 154 | 68 | 5 | 4.400 | 6249854 |

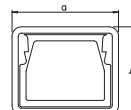

Edge protection ring for the open ends of LKM cable trunking.



Cable trunking, type LKM 60200

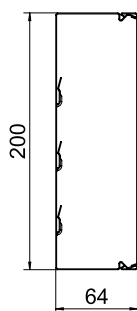
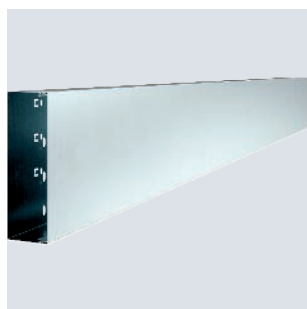

| Type | Colour | Length mm | Pack m | Weight kg/100 m | Item no. |
|------------|------------|--------------|-----------|--------------------|----------|
| LKM60200FS | — | 2000 | 2 | 338.700 | 6247164 |
| LKM60200RW | Pure white | 2000 | 2 | 338.700 | 6248667 |

Trunking cover and base with base perforation.
Equipotential bonding is guaranteed between the cover and the base without any additional aids.

Joint connector LKM SV60

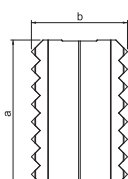

| Type | Dim. a mm | Dim. b mm | Pack Piece | Weight kg/100 pc. | Item no. |
|----------|-----------------|-----------------|---------------|----------------------|----------|
| LKM SV60 | 75 | 49 | 10 | 1.600 | 6247466 |

Joint connector to connect the bases. This creates the equipotential bonding between the duct bases.

Internal corner, for cable trunking type LKM 60200

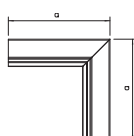
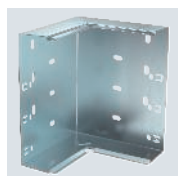

| Type | Colour | Dim. a mm | Pack Piece | Weight kg/100 pc. | Item no. |
|--------------|------------|-----------------|---------------|----------------------|----------|
| LKM I60200FS | — | 160 | 1 | 57.500 | 6248160 |
| LKM I60200RW | Pure white | 160 | 1 | 57.500 | 6249655 |

Internal corner for changing the direction of the LKM trunking.

External corner, for cable trunking type LKM 60200

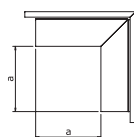
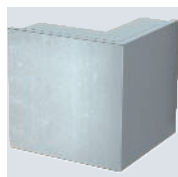

| Type | Colour | Dim. a mm | Pack Piece | Weight kg/100 pc. | Item no. |
|--------------|------------|-----------------|---------------|----------------------|----------|
| LKM A60200FS | — | 120 | 1 | 114.000 | 6248098 |
| LKM A60200RW | Pure white | 120 | 1 | 114.000 | 6249590 |

External corner including cover for changing the direction of the LKM ducts.

T piece, for cable trunking type LKM 60200

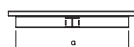

| Type | Colour | Dim. a mm | Pack Piece | Weight kg/100 pc. | Item no. |
|--------------|------------|-----------------|---------------|----------------------|----------|
| LKM T60200FS | — | 300 | 1 | 106.000 | 6248225 |
| LKM T60200RW | Pure white | 300 | 1 | 106.000 | 6249736 |

T piece including cover for changing the direction of the LKM trunking.

St FS FSK



Flat angle, for cable trunking type LKM 60200

| Type | Colour | Dim. a mm | Pack Piece | Weight kg/100 pc. | Item no. |
|--------------|------------|-----------|------------|-------------------|----------|
| LKM F60200FS | — | 140 | 1 | 154.400 | 6248020 |
| LKM F60200RW | Pure white | 140 | 1 | 154.400 | 6249523 |

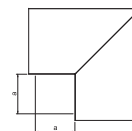

Flat angle including cover for changing the direction of the LKM ducts.

St FS FSK



End piece, for cable trunking type LKM 60200

| Type | Colour | Dim. a mm | Dim. b mm | Pack Piece | Weight kg/100 pc. | Item no. |
|--------------|------------|-----------|-----------|------------|-------------------|----------|
| LKM E60200FS | — | 200 | 64 | 10 | 10.800 | 6248322 |
| LKM E60200RW | Pure white | 200 | 64 | 10 | 11.500 | 6249833 |

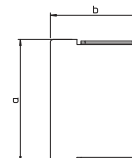

End piece for closing the LKM ducts.

PVC



Edge protection ring KSR 60200, for LKM cable trunking type 60200

| Type | Colour | Dim. a mm | Dim. b mm | Pack Piece | Weight kg/100 pc. | Item no. |
|----------|--------|-----------|-----------|------------|-------------------|----------|
| KSR60200 | Grey | 204 | 68 | 5 | 4.700 | 6249856 |

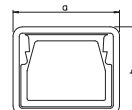

Edge protection ring for the open ends of LKM cable trunking.



Cable trunking, type LKM 80080

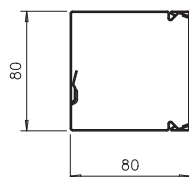

| Type | Colour | Length mm | Pack m | Weight kg/100 m | Item no. |
|------------|------------|--------------|-----------|--------------------|----------|
| LKM80080FS | — | 2000 | 2 | 215.000 | 6247194 |
| LKM80080RW | Pure white | 2000 | 2 | 238.000 | 6248694 |

Trunking cover and base with base perforation.
Equipotential bonding is guaranteed between the cover and the base without any additional aids.

Joint connector LKM SV80

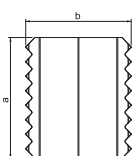

| Type | Dim. a mm | Dim. b mm | Pack Piece | Weight kg/100 pc. | Item no. |
|----------|-----------------|-----------------|---------------|----------------------|----------|
| LKM SV80 | 75 | 66 | 10 | 1.300 | 6247472 |

Joint connector to connect the bases. This creates the equipotential bonding between the duct bases.

Internal corner, for cable trunking type LKM 80080

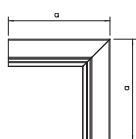
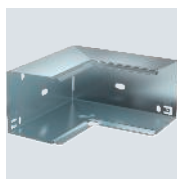

| Type | Colour | Dim. a mm | Pack Piece | Weight kg/100 pc. | Item no. |
|--------------|------------|-----------------|---------------|----------------------|----------|
| LKM I80080FS | — | 160 | 1 | 38.700 | 6248336 |
| LKM I80080RW | Pure white | 160 | 1 | 38.700 | 6248436 |

Internal corner for changing the direction of LKM trunking.

External corner, for cable trunking type LKM 80080

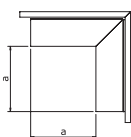
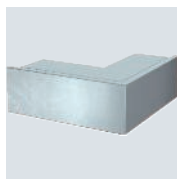

| Type | Colour | Dim. a mm | Pack Piece | Weight kg/100 pc. | Item no. |
|--------------|------------|-----------------|---------------|----------------------|----------|
| LKM A80080FS | — | 120 | 1 | 75.300 | 6248332 |
| LKM A80080RW | Pure white | 120 | 1 | 75.300 | 6248432 |

External corner including cover for changing the direction of the LKM ducts.

T piece, for cable trunking type LKM 80080



| Type | Colour | Dim. a mm | Pack Piece | Weight kg/100 pc. | Item no. |
|--------------|------------|-----------------|---------------|----------------------|----------|
| LKM T80080FS | — | 300 | 1 | 67.200 | 6248340 |
| LKM T80080RW | Pure white | 300 | 1 | 67.200 | 6248450 |

T piece including cover for changing the direction of the LKM ducts.

St FS FSK



Flat angle, for cable trunking type LKM 80080

| Type | Colour | Dim. a mm | Dim. b mm | Pack Piece | Weight kg/100 pc. | Item no. |
|--------------|------------|-----------|-----------|------------|-------------------|----------|
| LKM F80080FS | — | 140 | — | 1 | 80.000 | 6248328 |
| LKM F80080RW | Pure white | 140 | — | 1 | 80.000 | 6248428 |

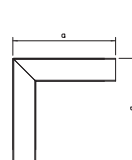

Flat angle including cover for changing the direction of the LKM ducts.

St FS FSK



End piece, for cable trunking type LKM 80080

| Type | Colour | Dim. a mm | Dim. b mm | Pack Piece | Weight kg/100 pc. | Item no. |
|--------------|------------|-----------|-----------|------------|-------------------|----------|
| LKM E80080FS | — | 80 | 80 | 1 | 7.000 | 6248344 |
| LKM E80080RW | Pure white | 80 | 80 | 1 | 7.000 | 6248454 |

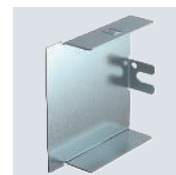
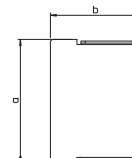

End piece for closing the LKM ducts.

PVC



Edge protection ring KSR 80080, for LKM cable trunking 80080

| Type | Colour | Dim. a mm | Dim. b mm | Pack Piece | Weight kg/100 pc. | Item no. |
|----------|--------|-----------|-----------|------------|-------------------|----------|
| KSR80080 | Grey | 84 | 84 | 5 | 3.800 | 6249865 |

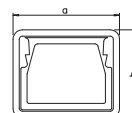

Edge protection ring for the open ends of LKM cable trunking.



Partitions

Partition LKM/TWS45

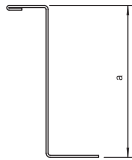
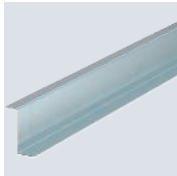

| Type | Length mm | Dim. | | Pack m | Weight kg/100 m | Item no. |
|-----------|--------------|---------|--|-----------|--------------------|----------|
| | | a mm | | | | |
| LKM TWS45 | 2000 | 45 | | 2 | 47.900 | 6249871 |

Partition to divide the LKM cable trunking, 60 mm trunking height, for different voltage levels.

Partition LKM TWS55

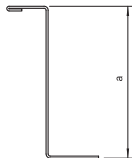

| Type | Length mm | Dim. | | Pack m | Weight kg/100 m | Item no. |
|-----------|--------------|---------|--|-----------|--------------------|----------|
| | | a mm | | | | |
| LKM TWS55 | 2000 | 55 | | 2 | 53.000 | 6249876 |

Partition to divide the LKM cable routing trunking, 60 mm trunking height, for different voltage levels.

Partition LKM TWS75

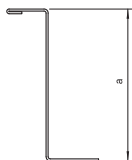
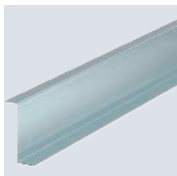

| Type | Length mm | Dim. | | Pack m | Weight kg/100 m | Item no. |
|-----------|--------------|---------|--|-----------|--------------------|----------|
| | | a mm | | | | |
| LKM TWS75 | 2000 | 60 | | 2 | 114.000 | 6249880 |

Partition to divide the LKM cable routing trunking, 80 mm trunking height, for different voltage levels.

Duct clamps

Duct clamp, LKM, trunking width 80

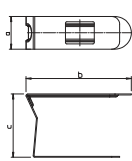

| Type | Dim. | | | Pack Piece | Weight kg/100 pc. | Item no. |
|---------|---------|---------|---------|---------------|----------------------|----------|
| | a mm | b mm | c mm | | | |
| LKM K65 | 25 | 60 | 65 | 20 | 2.330 | 6249882 |

The trunking clamp keeps the inserted cables in the trunking, thus simplifying installation on walls and ceilings. The trunking clamps are plugged onto the loop perforation and locked on the side wall. Suitable for trunking width 80 mm.

Duct clamp, LKM, trunking width 100

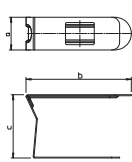

| Type | Dim. | | | Pack Piece | Weight kg/100 pc. | Item no. |
|---------|---------|---------|---------|---------------|----------------------|----------|
| | a mm | b mm | c mm | | | |
| LKM K80 | 25 | 81 | 49 | 20 | 2.700 | 6249884 |

The duct clamp keeps the inserted cables in the duct, thus simplifying installation on walls and ceilings. The duct clamps are plugged onto the loop perforation and locked on the side wall. Suitable for duct width 100 mm.

St FS



Duct clamp, LKM, trunking width 150 and 200

| Type | Dim. | Dim. | Dim. | Pack Piece | Weight kg/100 pc. | Item no. |
|----------|------|------|------|------------|-------------------|----------|
| | a mm | b mm | c mm | | | |
| LKM K140 | 25 | 141 | 49 | 20 | 3.600 | 6249888 |

The duct clamp keeps the inserted cables in the trunking, thus simplifying installation on walls and ceilings. The duct clamps are plugged onto the loop perforation and locked on the side wall. Suitable for trunking width 150 mm and 200 mm.

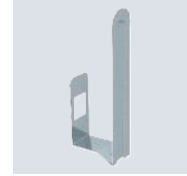
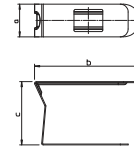

St FS



Duct clamp, LKM, for maintenance of electrical function E30 - E90

| Type | Pack Piece | Weight kg/100 pc. | Item no. |
|--------------|------------|-------------------|----------|
| LKM KF 60100 | 10 | 9.800 | 6249881 |

Duct clamp for the metal cable routing trunking type LKM 60100, prevents the cables falling out during installation. The duct clamp is essential if the trunking is used in cable systems with integrated maintenance of electrical function to DIN 4102, Part 12. Easy mounting through insertion into the loop perforation and interconnection in the side wall.

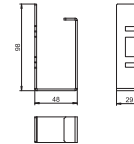

Cable brackets

St FS



LKM cable bracket, trunking width 60

| Type | Dim. a mm | Dim. b mm | For trunking dimension | Pack Piece | Weight kg/100 pc. | Item no. |
|---------|-----------|-----------|------------------------|------------|-------------------|----------|
| LKM Z60 | 46 | 30 | 60x60 mm | 10 | 1.100 | 6249906 |

Cable bracket to fix cables in vertical routing.

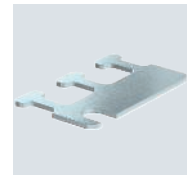
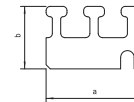

St FS



LKM cable bracket, trunking width 100

| Type | Dim. a mm | Dim. b mm | For trunking dimension | Pack Piece | Weight kg/100 pc. | Item no. |
|----------|-----------|-----------|------------------------|------------|-------------------|----------|
| LKM Z100 | 96 | 30 | 60x100 mm | 10 | 2.100 | 6249922 |

Cable bracket to fix cables in vertical routing.

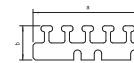

St FS



LKM cable bracket, trunking width 150

| Type | Dim. a mm | Dim. b mm | For trunking dimension | Pack Piece | Weight kg/100 pc. | Item no. |
|----------|-----------|-----------|------------------------|------------|-------------------|----------|
| LKM Z150 | 146 | 30 | 60x150 mm | 10 | 3.000 | 6249965 |

Cable bracket to fix cables in vertical routing.

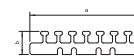

LKM cable bracket, trunking width 200

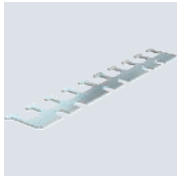

| Type | Dim. | Dim. | For trunking dimension | Pack | Weight | Item no. |
|----------|--------|-------|------------------------|-------|------------|----------|
| | a | b | | Piece | kg/100 pc. | |
| LKM Z200 | 166 mm | 30 mm | 60 x 200 mm | 10 | 3.600 | 6249981 |

Cable bracket to fix cables in vertical routing.



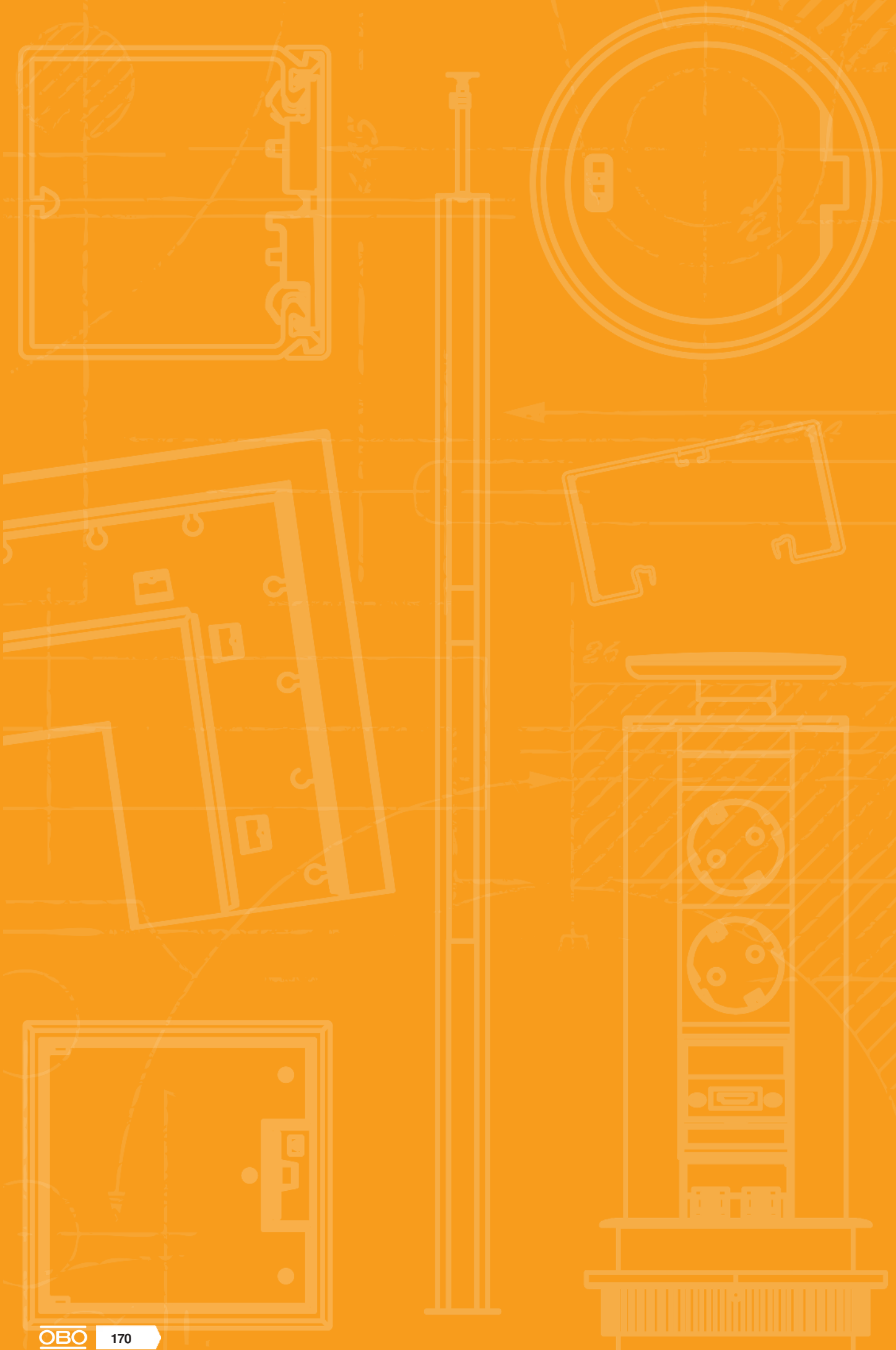

Skirting trunking

| | | |
|---|--------------------|-----|
|  | Trunking width 50 | 172 |
|  | Trunking width 70 | 182 |
|  | Trunking width 110 | 188 |
|  | Trunking width 105 | 192 |
|  | Floor trunking | 200 |



System overview

For all applications in single or multiple-occupier dwellings, whether a new building or renovation:

- The product range comprises the dimensions 20 x 50 mm, 20 x 70 mm and 20 x 110 mm
- Connection solutions for all standard devices in support ring and support clamp design
- Length of the standard profiles 2 m
- Versions available in RAL 9010 (trunking width: 50, 70 and 110 mm)
- Matching accessories to maintain the protection classes

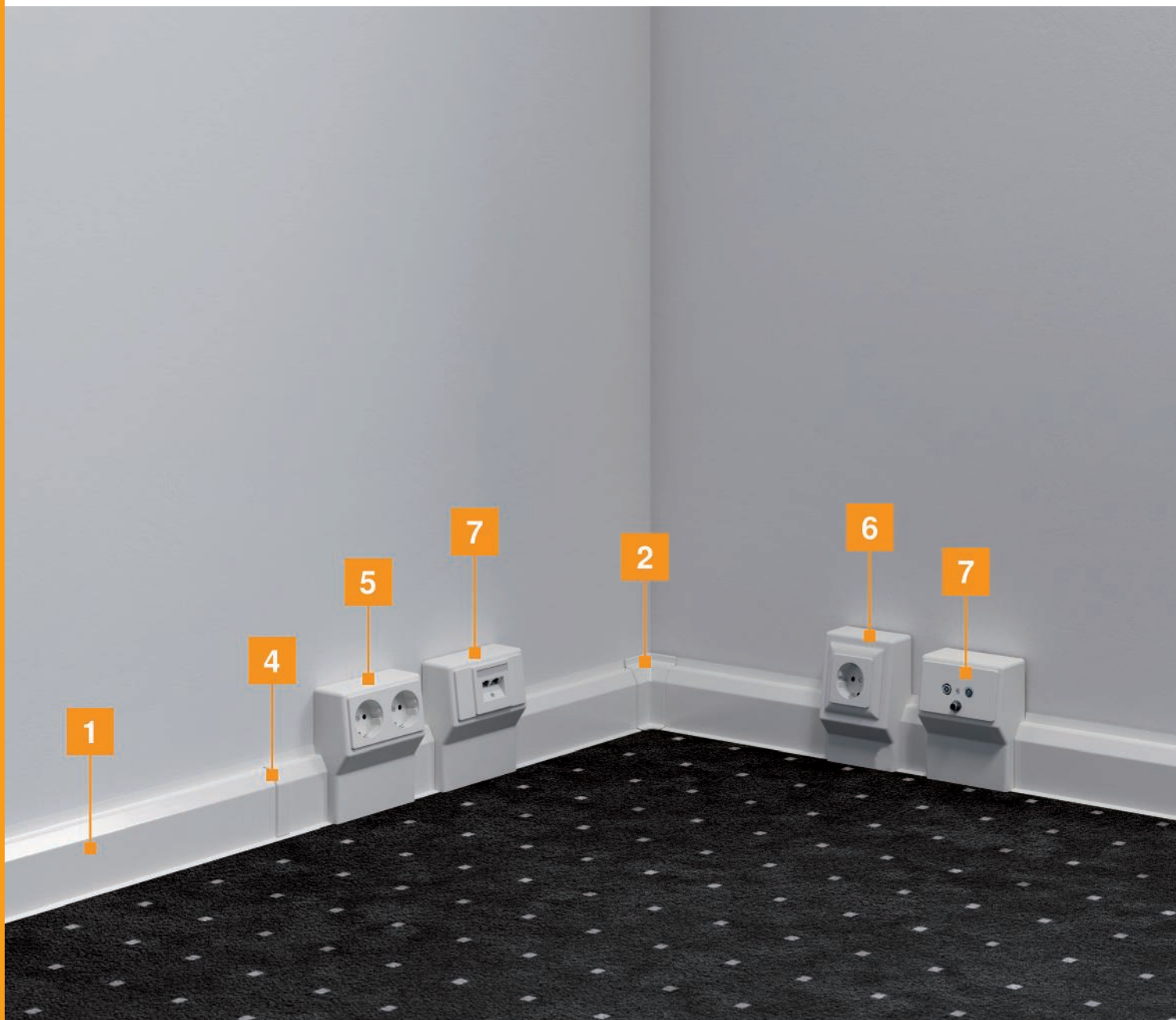

| | |
|---|---|
| 1 | Trunking |
| 2 | Internal corner |
| 3 | External corner |
| 4 | Cover coupling |
| 5 | Device support with integrated double socket |
| 6 | Device support, empty, for standard devices of support ring design |
| 7 | Device support, including panel, for the installation of central plate devices according to DIN 49075, with support clamp |



ne / en / 2023/05/02 10:01:36 10:01:36 (LLExpport_03294) / 2023/05/02 10:01:58 10:01:58

Mounting aid

Device support for universal devices

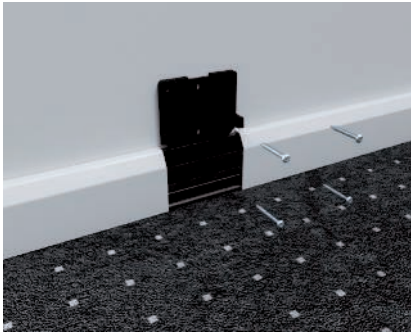

Apply the device support to the top of the base and screw to the wall.

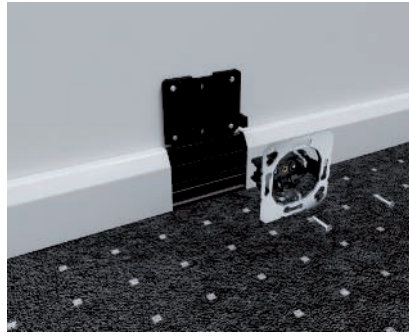

Connect and screw on the holder.

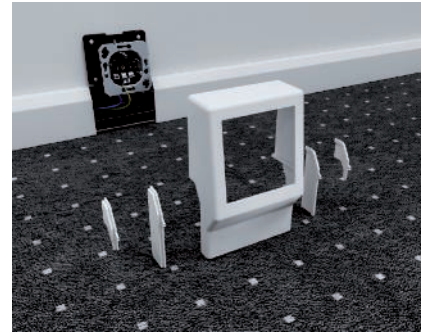

Select the adapter plate according to the height of the skirting board. No adapter plate is available for SL 20 x 110.



Clip the front plate onto the cover.



Mount the connection cover.



Mounted device support.

Mounting aid

Device support with pre-terminated double socket

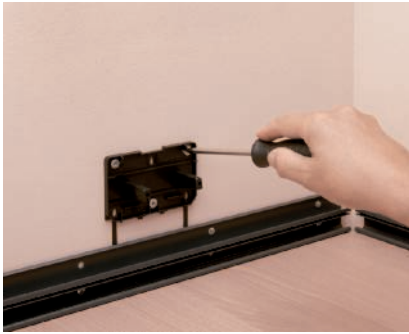

At trunking heights of 50 mm, apply the device support to the mounted skirting trunking base in such a way that the two struts serve as spacers. Then, drill the hole and screw to the wall (image without mounted socket base).

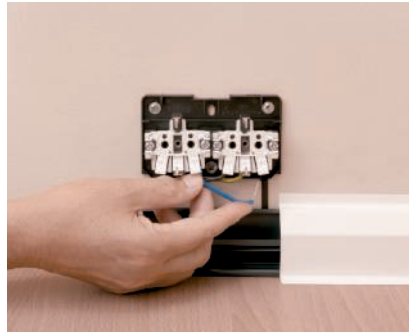

Connect the device support.

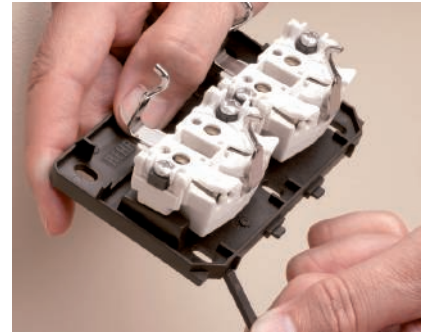

Place the device support directly on the base. When using the 70 mm-high SL trunking, break out the two bars (spacers).



When using the SL duct of 50 mm duct height before mounting the device tank, insert the supplied adapter plate on both sides.



Hang the device tank in the SL base.



Place the device panel, including the screw, in the opening of the device tank and screw it tight.



After mounting, an electrical test must be performed by an authorised electrical engineer.

Mounting aid

Device support for devices with support clamp

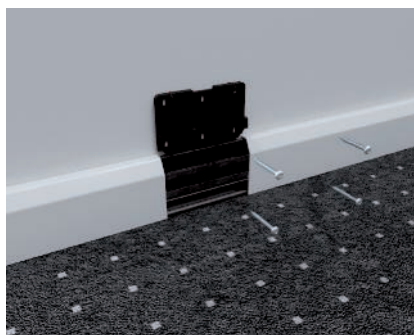

Apply the device support to the top of the base and screw to the wall.

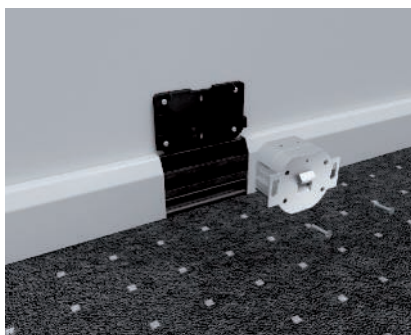

Connect and screw on the holder.

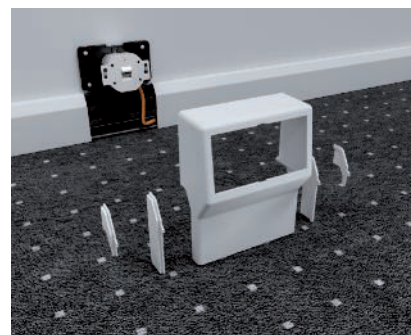

Select the adapter plate according to the height of the skirting board. No adapter plate is available for SL 20 x 110.



Clip the front plate onto the cover.



Mount the connection cover.



Mounted device support.

PVC



Skirting trunking SL 2050

| Type | Colour | Length mm | Width mm | Height mm | Pack m | Weight kg/100 m | Item no. |
|-------------|------------|--------------|-------------|--------------|-----------|--------------------|----------|
| SL 2050 rws | Pure white | 2000 | 50 | 20 | 2 | 35.100 | 6132193 |
| SL 2050 cws | Cream | 2000 | 50 | 20 | 2 | 40.290 | 6132201 |

SL skirting trunking for covered cable routing in internal areas. The colour of the trunking bases can vary depending on the production method.

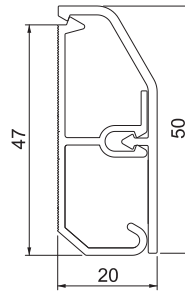

PVC



Internal corner SL IE2050

| Type | Colour | Length mm | Width mm | Height mm | Pack Piece | Weight kg/100 pc. | Item no. |
|---------------|------------|--------------|-------------|--------------|---------------|----------------------|----------|
| SL IE2050 rws | Pure white | 46 | 46 | 52 | 10 | 0.400 | 6132248 |
| SL IE2050 cws | Cream | 46 | 46 | 52 | 10 | 0.400 | 6132249 |

Internal corner as a fitting for changing the direction of the skirting trunking.

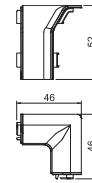

PVC



External corner SL AE2050

| Type | Colour | Length mm | Width mm | Height mm | Pack Piece | Weight kg/100 pc. | Item no. |
|---------------|------------|--------------|-------------|--------------|---------------|----------------------|----------|
| SL AE2050 rws | Pure white | 37 | 37 | 51 | 10 | 1.160 | 6132265 |
| SL AE2050 cws | Cream | 37 | 37 | 51 | 10 | 1.160 | 6132266 |

External corner as a fitting for changing the direction of the skirting trunking.

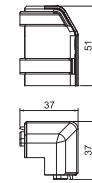

PVC



End piece SL ESli2050

| Type | Colour | Length mm | Width mm | Height mm | Pack Piece | Weight kg/100 pc. | Item no. |
|-----------------|------------|--------------|-------------|--------------|---------------|----------------------|----------|
| SL ESli2050 rws | Pure white | 22 | 18 | 52 | 10 | 0.500 | 6132293 |
| SL ESli2050 cws | Cream | 22 | 18 | 52 | 10 | 0.500 | 6132294 |

End piece (left) as a fitting for the skirting trunking.



PVC



End piece SL ESre2050

| Type | Colour | Length mm | Width mm | Height mm | Pack Piece | Weight kg/100 pc. | Item no. |
|-----------------|------------|--------------|-------------|--------------|---------------|----------------------|----------|
| SL ESre2050 rws | Pure white | 22 | 18 | 52 | 10 | 0.500 | 6132277 |
| SL ESre2050 cws | Cream | 22 | 18 | 52 | 10 | 0.500 | 6132278 |

End piece (right) as a fitting for the skirting trunking.

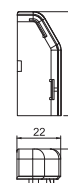

Coupling SL KUP2050

PVC

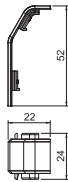

| Type | Colour | Length mm | Width mm | Height mm | Pack Piece | Weight kg/100 pc. | Item no. |
|-----------------------|------------|--------------|-------------|--------------|---------------|----------------------|----------------|
| SL KUP2050 rws | Pure white | 24 | 22 | 52 | 10 | 0.400 | 6132225 |
| SL KUP2050 cws | Cream | 24 | 22 | 52 | 10 | 0.400 | 6132226 |

Trunking coupling for SL, SL-L and SL-T skirting trunking. For connecting the interfaces of the individual trunking covers.

Cover SL 2050

PVC

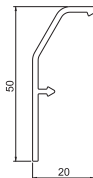

| Type | Colour | Length mm | Width mm | Height mm | Pack m | Weight kg/100 m | Item no. |
|-----------------------|------------|--------------|-------------|--------------|-----------|--------------------|----------------|
| SL 2050 OT cws | Cream | 2000 | 20 | 3 | 120 | 17.270 | 6132308 |
| SL 2050 OT rws | Pure white | 2000 | 50 | 20 | 2 | 15.700 | 6132150 |
| SLL 2050 cws | Cream | 2000 | 50 | 20 | 2 | 19.660 | 6132157 |
| SLL 2050 rws | Pure white | 2000 | 50 | 20 | 2 | 19.660 | 6132158 |
| SLL 2070 rws | Pure white | 2000 | 50 | 70 | 2 | 24.880 | 6132159 |

Cover for skirting trunking.

PVC



Skirting trunking SLL 2050

| Type | Colour | Length mm | Width mm | Height mm | Pack m | Weight kg/100 m | Item no. |
|--------------|------------|--------------|-------------|--------------|-----------|--------------------|----------|
| SLL 2050 rws | Pure white | 2000 | 50 | 20 | 2 | 41.160 | 6132212 |
| SLL 2050 cws | Cream | 2000 | 50 | 20 | 2 | 41.160 | 6132211 |

SL-L skirting trunking for covered cable routing in internal areas. The colour of the trunking bases can vary depending on the production method.

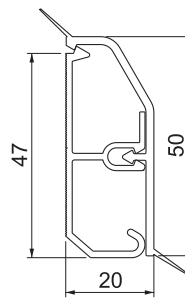

PVC



Internal corner SLL IE2050

| Type | Colour | Length mm | Width mm | Height mm | Pack Piece | Weight kg/100 pc. | Item no. |
|----------------|------------|--------------|-------------|--------------|---------------|----------------------|----------|
| SLL IE2050 rws | Pure white | 45 | 45 | 60 | 10 | 0.900 | 6132240 |
| SLL IE2050 cws | Cream | 45 | 45 | 60 | 10 | 0.900 | 6132241 |

Internal corner as a fitting for changing the direction of the skirting trunking.

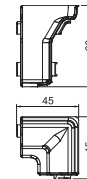

PVC



External corner SLL AE2050

| Type | Colour | Length mm | Width mm | Height mm | Pack Piece | Weight kg/100 pc. | Item no. |
|----------------|------------|--------------|-------------|--------------|---------------|----------------------|----------|
| SLL AE2050 rws | Pure white | 46 | 46 | 60 | 10 | 1.750 | 6132260 |
| SLL AE2050 cws | Cream | 46 | 46 | 60 | 10 | 1.320 | 6132261 |

External corner as a fitting for changing the direction of the skirting trunking.

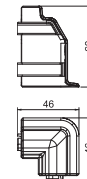

Skirting trunking SLT 2050

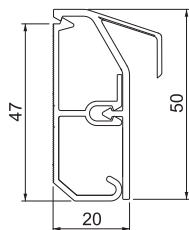

| Type | Colour | Length mm | Width mm | Height mm | Pack m | Weight kg/100 m | Item no. |
|--------------|------------|--------------|-------------|--------------|-----------|--------------------|----------|
| SLT 2050 rws | Pure white | 2000 | 50 | 20 | 2 | 40.200 | 6132218 |
| SLT 2050 cws | Cream | 2000 | 50 | 20 | 2 | 40.200 | 6132217 |

SL-T skirting trunking for covered cable routing in internal areas. The colour of the trunking bases can vary depending on the production method.

End piece SLT ESli2050

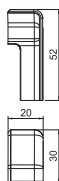

| Type | Colour | Length mm | Width mm | Height mm | Pack Piece | Weight kg/100 pc. | Item no. |
|------------------|------------|--------------|-------------|--------------|---------------|----------------------|----------|
| SLT ESli2050 rws | Pure white | 30 | 20 | 52 | 10 | 0.600 | 6132288 |
| SLT ESli2050 cws | Cream | 30 | 20 | 52 | 10 | 0.600 | 6132289 |

End piece (left) as a fitting for the skirting trunking.

End piece SLT ESre2050

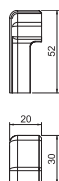

| Type | Colour | Length mm | Width mm | Height mm | Pack Piece | Weight kg/100 pc. | Item no. |
|------------------|------------|--------------|-------------|--------------|---------------|----------------------|----------|
| SLT ESre2050 rws | Pure white | 30 | 20 | 52 | 10 | 0.600 | 6132302 |
| SLT ESre2050 cws | Cream | 30 | 20 | 52 | 10 | 0.600 | 6132303 |

End piece (right) as a fitting for the skirting trunking.



Skirting trunking SL 2070

PVC

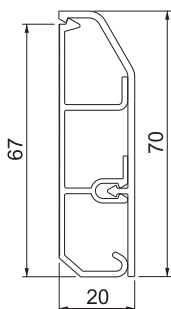

| Type | Colour | Length mm | Width mm | Height mm | Pack m | Weight kg/100 m | Item no. |
|-------------|------------|--------------|-------------|--------------|-----------|--------------------|----------|
| SL 2070 rws | Pure white | 2000 | 70 | 20 | 2 | 48.000 | 6132267 |
| SL 2070 cws | Cream | 2000 | 70 | 20 | 2 | 48.000 | 6132208 |
| SL 2070 lgr | Light grey | 2000 | 70 | 20 | 2 | 48.000 | 6132269 |

SL skirting trunking for covered cable routing in internal areas. The colour of the trunking bases can vary depending on the production method.

Internal corner SL IE2070

PVC

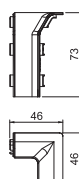

| Type | Colour | Length mm | Width mm | Height mm | Pack Piece | Weight kg/100 pc. | Item no. |
|---------------|------------|--------------|-------------|--------------|---------------|----------------------|----------|
| SL IE2070 rws | Pure white | 46 | 46 | 73 | 10 | 0.700 | 6132253 |
| SL IE2070 cws | Cream | 46 | 46 | 73 | 10 | 0.700 | 6132254 |
| SL IE2070 lgr | Light grey | 46 | 46 | 73 | 10 | 0.700 | 6132255 |

Internal corner as a fitting for changing the direction of the skirting trunking.

External corner SL AE2070

PVC

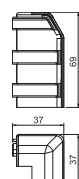

| Type | Colour | Length mm | Width mm | Height mm | Pack Piece | Weight kg/100 pc. | Item no. |
|---------------|------------|--------------|-------------|--------------|---------------|----------------------|----------|
| SL AE2070 rws | Pure white | 37 | 37 | 69 | 10 | 1.530 | 6132270 |
| SL AE2070 cws | Cream | 37 | 37 | 69 | 10 | 1.530 | 6132271 |
| SL AE2070 lgr | Light grey | 37 | 37 | 69 | 10 | 1.300 | 6132272 |

External corner as a fitting for changing the direction of the skirting trunking.

End piece SL ESli2070

PVC

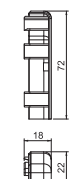

| Type | Colour | Length mm | Width mm | Height mm | Pack Piece | Weight kg/100 pc. | Item no. |
|-----------------|------------|--------------|-------------|--------------|---------------|----------------------|----------|
| SL ESli2070 rws | Pure white | 22 | 18 | 72 | 10 | 0.600 | 6132296 |
| SL ESli2070 cws | Cream | 22 | 18 | 72 | 10 | 0.600 | 6132297 |
| SL ESli2070 lgr | Light grey | 22 | 18 | 72 | 10 | 0.600 | 6132298 |

End piece (left) as a fitting for the skirting trunking.

End piece SL ESre2070

PVC

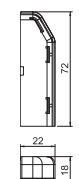

| Type | Colour | Length mm | Width mm | Height mm | Pack Piece | Weight kg/100 pc. | Item no. |
|-----------------|------------|--------------|-------------|--------------|---------------|----------------------|----------|
| SL ESre2070 rws | Pure white | 22 | 18 | 72 | 10 | 0.600 | 6132281 |
| SL ESre2070 cw | Cream | 22 | 18 | 72 | 10 | 0.600 | 6132282 |
| SL ESre2070 lgr | Light grey | 22 | 18 | 72 | 10 | 0.600 | 6132283 |

End piece (right) as a fitting for the skirting trunking.

PVC



Coupling SL KUP2070

| Type | Colour | Length mm | Width mm | Height mm | Pack Piece | Weight kg/100 pc. | Item no. |
|----------------|------------|--------------|-------------|--------------|---------------|----------------------|----------|
| SL KUP2070 rws | Pure white | 24 | 22 | 70 | 10 | 0.500 | 6132230 |
| SL KUP2070 cws | Cream | 24 | 22 | 70 | 10 | 0.500 | 6132231 |
| SL KUP2070 lgr | Light grey | 24 | 22 | 70 | 10 | 0.500 | 6132232 |

Trunking coupling for SL, SL-L and SL-T skirting trunking. For linking the joints of individual trunking covers.

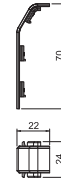

Skirting trunking SLL 2070

PVC

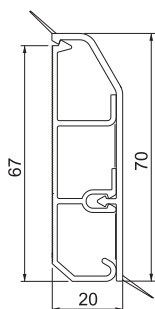

| Type | Colour | Length mm | Width mm | Height mm | Pack m | Weight kg/100 m | Item no. |
|---------------------|------------|--------------|-------------|--------------|-----------|--------------------|----------------|
| SLL 2070 rws | Pure white | 2000 | 70 | 20 | 2 | 57.396 | 6132215 |
| SLL 2070 cws | Cream | 2000 | 70 | 20 | 2 | 57.400 | 6132214 |

SL-L skirting trunking for covered cable routing in internal areas. The colour of the trunking bases can vary depending on the production method.

Internal corner SLL IE2070

PVC

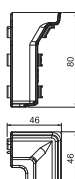

| Type | Colour | Length mm | Width mm | Height mm | Pack Piece | Weight kg/100 pc. | Item no. |
|-----------------------|------------|--------------|-------------|--------------|---------------|----------------------|----------------|
| SLL IE2070 rws | Pure white | 46 | 46 | 80 | 10 | 1.200 | 6132243 |
| SLL IE2070 cws | Cream | 46 | 46 | 80 | 10 | 1.200 | 6132244 |

Internal corner as a fitting for changing the direction of the skirting trunking.

External corner SLL AE2070

PVC

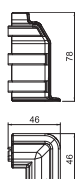

| Type | Colour | Length mm | Width mm | Height mm | Pack Piece | Weight kg/100 pc. | Item no. |
|-----------------------|------------|--------------|-------------|--------------|---------------|----------------------|----------------|
| SLL AE2070 rws | Pure white | 78 | 46 | 46 | 10 | 1.750 | 6132262 |
| SLL AE2070 cws | Cream | 78 | 46 | 46 | 10 | 1.750 | 6132263 |

External corner as a fitting for changing the direction of the skirting trunking.

PVC



Skirting trunking SLT 2070

| Type | Colour | Length mm | Width mm | Height mm | Pack m | Weight kg/100 m | Item no. |
|--------------|------------|--------------|-------------|--------------|-----------|--------------------|----------|
| SLT 2070 rws | Pure white | 2000 | 70 | 20 | 2 | 52.900 | 6132222 |
| SLT 2070 cws | Cream | 2000 | 70 | 20 | 2 | 53.000 | 6132221 |

SL-T skirting trunking for covered cable routing in internal areas. The colour of the trunking bases can vary depending on the production method.

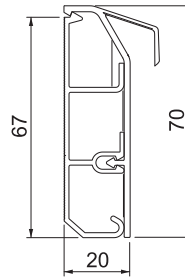

PVC



End piece SLT ESli2070

| Type | Colour | Length mm | Width mm | Height mm | Pack Piece | Weight kg/100 pc. | Item no. |
|------------------|------------|--------------|-------------|--------------|---------------|----------------------|----------|
| SLT ESli2070 rws | Pure white | 30 | 20 | 72 | 10 | 0.800 | 6132291 |
| SLT ESli2070 cws | Cream | 30 | 20 | 72 | 10 | 0.800 | 6132320 |

End piece (left) as a fitting for the skirting trunking.

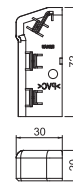

PVC



End piece SLT ESre2070

| Type | Colour | Length mm | Width mm | Height mm | Pack Piece | Weight kg/100 pc. | Item no. |
|------------------|------------|--------------|-------------|--------------|---------------|----------------------|----------|
| SLT ESre2070 rws | Pure white | 30 | 20 | 72 | 10 | 0.800 | 6132305 |
| SLT ESre2070 cws | Cream | 30 | 20 | 72 | 10 | 0.800 | 6132306 |

End piece (right) as a fitting for the skirting trunking.

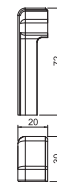

Accessories, skirting trunking SL

PVC



Device support SL2GT5070

| Type | Colour | Length mm | Width mm | Height mm | Pack Piece | Weight kg/100 pc. | Item no. |
|---------------|------------|--------------|-------------|--------------|---------------|----------------------|----------|
| SL2GT5070 rws | Pure white | 52 | 111 | 138 | 1 | 15.000 | 6132245 |
| SL2GT5070 cws | Cream | 52 | 111 | 138 | 1 | 14.000 | 6132246 |
| SL2GT5070 lgr | Light grey | 52 | 111 | 138 | 1 | 14.000 | 6132247 |

Device support with pre-terminated double protective contact socket for the skirting trunking in the trunking widths 50 and 70 mm.

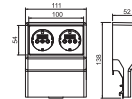

PVC



Device support SL ETler5070

| Type | Colour | Length mm | Width mm | Height mm | Pack Piece | Weight kg/100 pc. | Item no. |
|------------------|------------|--------------|-------------|--------------|---------------|----------------------|----------|
| SL ETler5070 rws | Pure white | 50 | 96 | 146 | 1 | 11.800 | 6132238 |
| SL ETler5070 cws | Cream | 50 | 96 | 146 | 1 | 11.800 | 6132239 |
| SL ETler5070 lgr | Light grey | 50 | 96 | 146 | 1 | 11.800 | 6132237 |

Empty device support for skirting trunking for the installation of standard devices in support ring and support clamp form with 60 mm fastening track.

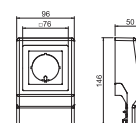

Device support SL GTO 50-70

PVC

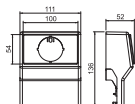

| Type | Colour | Length mm | Width mm | Height mm | Pack Piece | Weight kg/100 pc. | Item no. |
|-------------------------|------------|--------------|-------------|--------------|---------------|----------------------|----------------|
| SL GTO 50-70 rws | Pure white | 52 | 111 | 136 | 1 | 13.300 | 6132229 |
| SL GTO 50-70 cws | Cream | 52 | 111 | 136 | 1 | 13.300 | 6132224 |
| SL GTO 50-70 lgr | Light grey | 52 | 111 | 136 | 1 | 13.300 | 6132223 |

Empty device support for the SL, SL-L and SL-T skirting trunking systems for the installation of devices in support clamp form (according to DIN 49075) in the trunking widths 50 and 70 mm.

Device support SL2GTK5070

PVC

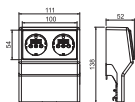

| Type | Colour | Length mm | Width mm | Height mm | Pack Piece | Weight kg/100 pc. | Item no. |
|-----------------------|------------|--------------|-------------|--------------|---------------|----------------------|----------------|
| SL2GTK5070 rws | Pure white | 52 | 111 | 138 | 1 | 15.000 | 6132179 |
| SL2GTK5070 cws | Cream | 52 | 111 | 138 | 1 | 14.000 | 6132178 |

Device support with pre-terminated double protective contact socket with increased contact protection for the skirting trunking in the trunking widths 50 and 70 mm.

PC/
ABS



Blind cover SL BL blind

| Type | Colour | Length mm | Width mm | Height mm | Pack Piece | Weight kg/100 pc. | Item no. |
|-----------------|------------|--------------|-------------|--------------|---------------|----------------------|----------|
| SL BL blind rws | Pure white | 54 | 100 | 7 | 1 | 1.950 | 6132199 |
| SL BL blind cws | Cream | 54 | 100 | 7 | 1 | 1.950 | 6132252 |

Blanking cover for closing the service outlet.

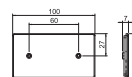

PC/
ABS



Antenna socket panel SL BL ANT

| Type | Colour | Length mm | Width mm | Height mm | Pack Piece | Weight kg/100 pc. | Item no. |
|---------------|------------|--------------|-------------|--------------|---------------|----------------------|----------|
| SL BL ANT rws | Pure white | 100 | 54 | 5 | 1 | 2.100 | 6132258 |
| SL BL ANT cws | Cream | 100 | 54 | 5 | 1 | 2.100 | 6132195 |

Antenna cover for installing antenna sockets in the device tank of the skirting trunking. Cover for antenna socket.

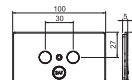

PVC



Side closure, device tank SL GTSA5070

| Type | Colour | Length mm | Width mm | Height mm | Pack Piece | Weight kg/100 pc. | Item no. |
|-----------------|------------|--------------|-------------|--------------|---------------|----------------------|----------|
| SL GTSA5070 rws | Pure white | 4 | 27 | 72 | 10 | 0.320 | 6132234 |
| SL GTSA5070 cws | Cream | 4 | 27 | 72 | 10 | 0.320 | 6132197 |

Side cover panel for side enclosing of the service outlet.

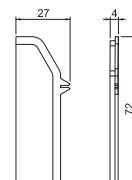

Skirting trunking SL 20110

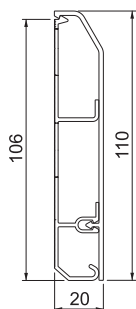

| Type | Colour | Length mm | Width mm | Height mm | Pack m | Weight kg/100 m | Item no. |
|--------------|------------|--------------|-------------|--------------|-----------|--------------------|----------|
| SL 20110 rws | Pure white | 2000 | 110 | 20 | 2 | 70.100 | 6132274 |

SL skirting trunking for covered cable routing in internal areas. The colour of the trunking bases can vary depending on the production method.

Skirting trunking SL 20110

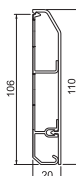

| Type | Colour | Length mm | Width mm | Height mm | Pack m | Weight kg/100 m | Item no. |
|--------------|------------|--------------|-------------|--------------|-----------|--------------------|----------|
| SL 20110 rws | Pure white | 2000 | 110 | 20 | 18 | 70.100 | 6132207 |

SL skirting trunking for covered cable routing in internal areas. The colour of the trunking bases can vary depending on the production method.

Internal corner SL IE20110

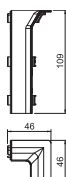

| Type | Colour | Length mm | Width mm | Height mm | Pack Piece | Weight kg/100 pc. | Item no. |
|----------------|------------|--------------|-------------|--------------|---------------|----------------------|----------|
| SL IE20110 rws | Pure white | 46 | 46 | 109 | 10 | 0.900 | 6132259 |

Internal corner as a fitting for changing the direction of the skirting trunking.

External corner SL AE20110

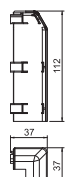

| Type | Colour | Length mm | Width mm | Height mm | Pack Piece | Weight kg/100 pc. | Item no. |
|----------------|------------|--------------|-------------|--------------|---------------|----------------------|----------|
| SL AE20110 rws | Pure white | 37 | 37 | 112 | 10 | 1.800 | 6132275 |

External corner as a fitting for changing the direction of the skirting trunking.

End piece SL ESI20110



| Type | Colour | Length mm | Width mm | Height mm | Pack Piece | Weight kg/100 pc. | Item no. |
|-----------------|------------|--------------|-------------|--------------|---------------|----------------------|----------|
| SL ESI20110 rws | Pure white | 22 | 18 | 112 | 10 | 0.900 | 6132300 |

End piece (left) as a fitting for the skirting trunking.

PVC



End piece SL ESre20110

| Type | Colour | Length mm | Width mm | Height mm | Pack Piece | Weight kg/100 pc. | Item no. |
|------------------|------------|--------------|-------------|--------------|---------------|----------------------|----------|
| SL ESre20110 rws | Pure white | 22 | 18 | 112 | 10 | 0.900 | 6132286 |

End piece (right) as a fitting for the skirting trunking.

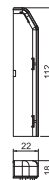

PVC



Coupling SL KUP20110

| Type | Colour | Length mm | Width mm | Height mm | Pack Piece | Weight kg/100 pc. | Item no. |
|-----------------|------------|--------------|-------------|--------------|---------------|----------------------|----------|
| SL KUP20110 rws | Pure white | 24 | 22 | 110 | 10 | 0.600 | 6132235 |

Trunking coupling for SL, SL-L and SL-T skirting trunking. For connecting the interfaces of the individual trunking covers.



Accessories, skirting trunking SL

PVC



Device support SL 2GT20110

| Type | Colour | Length mm | Width mm | Height mm | Pack Piece | Weight kg/100 pc. | Item no. |
|----------------|------------|--------------|-------------|--------------|---------------|----------------------|----------|
| SL2GT20110 rws | Pure white | 52 | 111 | 176 | 1 | 15.400 | 6132250 |

Device support with pre-terminated double protective contact socket for the skirting trunking in the trunking width 110 mm.

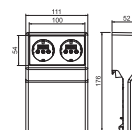

PVC



Device support SL ETler20110

| Type | Colour | Length mm | Width mm | Height mm | Pack Piece | Weight kg/100 pc. | Item no. |
|-------------------|------------|--------------|-------------|--------------|---------------|----------------------|----------|
| SL ETler20110 rws | Pure white | 50 | 96 | 184 | 1 | 13.400 | 6132242 |

Empty device support for skirting trunking for the installation of standard devices in support ring and support clamp form with 60 mm fastening track.

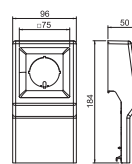

PVC



Device support SL GTler20110

| Type | Colour | Length mm | Width mm | Height mm | Pack Piece | Weight kg/100 pc. | Item no. |
|-------------------|------------|--------------|-------------|--------------|---------------|----------------------|----------|
| SL GTler20110 rws | Pure white | 52 | 111 | 177 | 1 | 14.600 | 6132236 |

Empty device support for skirting trunking for the installation of devices in support clamp form (according to DIN 49075) in trunking width 110 mm.

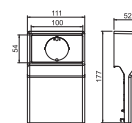

Antenna socket panel SL BL ANT

PC / ABS

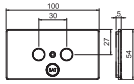

| Type | Colour | Length mm | Width mm | Height mm | Pack Piece | Weight kg/100 pc. | Item no. |
|---------------|------------|--------------|-------------|--------------|---------------|----------------------|----------|
| SL BL ANT rws | Pure white | 100 | 54 | 5 | 1 | 2.100 | 6132258 |
| SL BL ANT cws | Cream | 100 | 54 | 5 | 1 | 2.100 | 6132195 |

Antenna cover for installing antenna sockets in the device tank of the skirting trunking. Cover for antenna socket.

Blind cover SL BL blind

PC / ABS

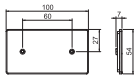

| Type | Colour | Length mm | Width mm | Height mm | Pack Piece | Weight kg/100 pc. | Item no. |
|-----------------|------------|--------------|-------------|--------------|---------------|----------------------|----------|
| SL BL blind rws | Pure white | 54 | 100 | 7 | 1 | 1.950 | 6132199 |
| SL BL blind cws | Cream | 54 | 100 | 7 | 1 | 1.950 | 6132252 |

Blanking cover for closing the service outlet.



System overview

Base perforation

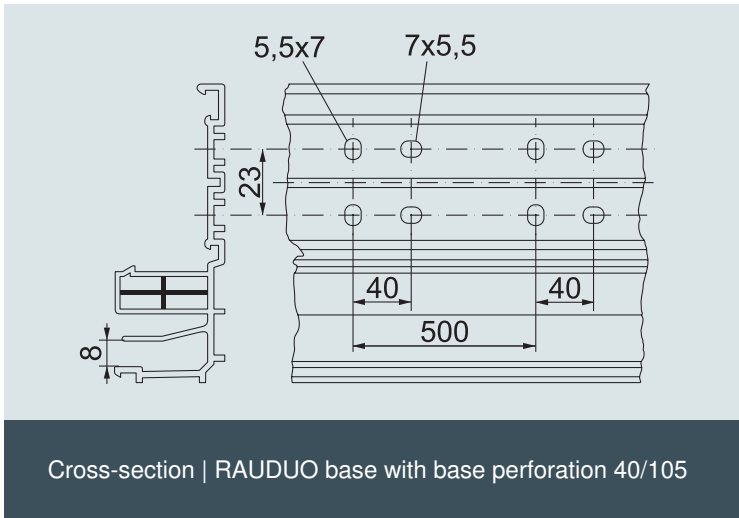

Bases:

The base perforation (slots) simplifies mounting.

Covers:

Either with or without sealing lip.

Heating pipes:

Suitable up to 20 mm external diameter. Fastening through the heating pipe support, which is engaged in the base.

Internal/external corners:

The bases must be given mitre cuts to exclude heat being drawn away (from the heating chamber into the electrical chamber). In the case of poor structural conditions (uneven walls, etc.), we recommend closing off any gap that may appear when separating the chambers with silicone.

End pieces:

Adhesion must take place for VDE-compliant mounting.

Heating temperatures:

The RAUDUO system is designed for a flow temperature of 70 °C and a return temperature of 55 °C (according to the VDE information report). With a flow temperature of up to 90 °C and a return temperature of up to 70 °C, the VDE report requires the device tank insulation to be replaced with "90 °C insulation foam", item no. 6132175.



| | |
|---|---|
| 1 | Trunking |
| 2 | Internal corner |
| 3 | External corner |
| 4 | Cover coupling |
| 5 | Device support with integrated double socket |
| 6 | Device support, including panel, for the installation of central plate devices according to DIN 49075, with support clamp |

Installation options RAUDUO device tank

UAE connection sockets

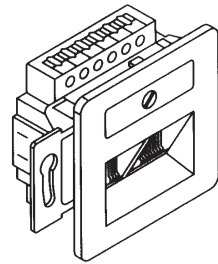

UAE 8/8

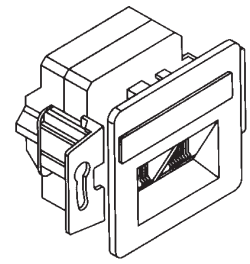

UAE 8/8 Cat 6

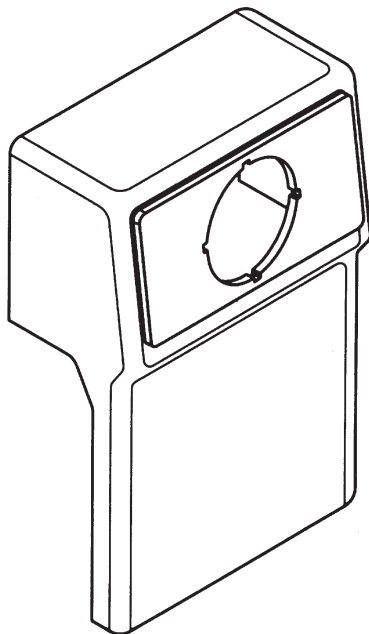

Device tank, empty, incl. panel (DIN 49075)

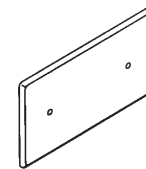

Blanking cover (use as clamping socket)

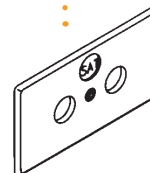

Cover for antenna construction (with predetermined breakout point for SAT)

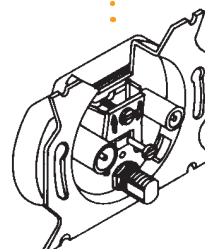

Socket for SAT and BK



Note: The supplied panel is suitable for devices according to DIN 49075 with support bars/brackets.

Mounting of RAUDUO device tank with double socket

Mounting steps

1

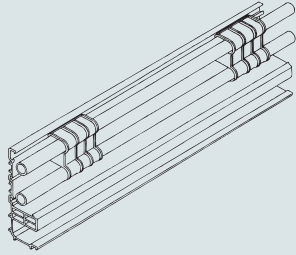

Mounting requirement
a) Mounted trunking base
b) Installed heating system

2

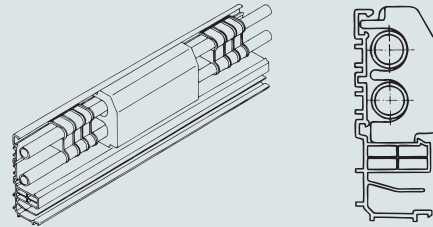

Insert the device tank insulation in the trunking base (at flow temperatures over 70 °C, the solid foam variant, item no. 6132175 must be used!).

3

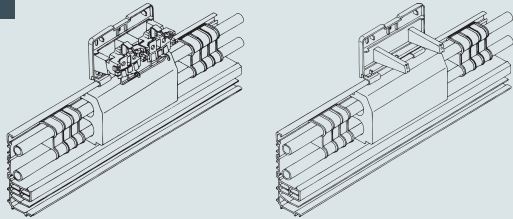

Position the device tank (centrally to the insulation). Then, draw on the drill holes, drill the holes and screw the device support tight.

4

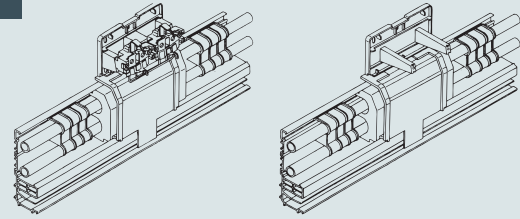

Engage the potential separation plate in the trunking base. The insulation must protrude evenly on the left and the right.

5

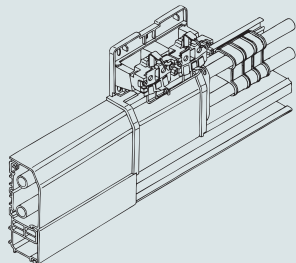

Place the cables separately in the clamps and connect the socket and other connection devices. Close both trunking chambers (electrical and heating chambers) using the shared cover. The trunking covers abut the grooves of the potential separation plate on the right and left.

6

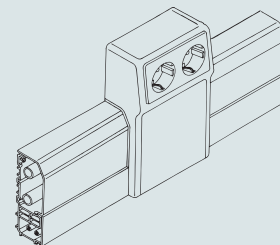

Mount the device tank with cover on the base and close with the cover.

Skirting trunking Rauduo 40105

PVC

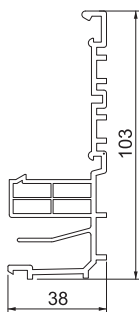

| Type | Length mm | Width mm | Height mm | Pack m | Weight kg/100 m | Item no. |
|-----------------------|--------------|-------------|--------------|-----------|--------------------|----------------|
| RD 40105 natur | 2000 | 103.4 | 38 | 2 | 74.000 | 6132205 |

Base of the Rauduo trunking system with 2 individual, thermally separated chambers for joint laying of electrical cables and heating pipes. With locking function for accommodating the trunking covers. The colour of the trunking bases can vary depending on the production method.

Trunking cover Rauduo OT40105, without sealing lip

PVC

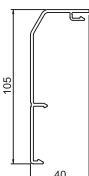

| Type | Colour | Length mm | Width mm | Height mm | Pack m | Weight kg/100 m | Item no. |
|-----------------------|------------|--------------|-------------|--------------|-----------|--------------------|----------------|
| RD OT40105 rws | Pure white | 2000 | 105.3 | 40 | 2 | 46.341 | 6132160 |
| RD OT40105 cws | Cream | 2000 | 105.3 | 40 | 2 | 46.341 | 6132161 |

Cover for Rauduo trunking.

Trunking cover Rauduo OT40105, with sealing lip

PVC

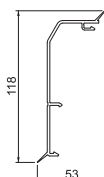

| Type | Colour | Length mm | Width mm | Height mm | Pack m | Weight kg/100 m | Item no. |
|------------------------|------------|--------------|-------------|--------------|-----------|--------------------|----------------|
| RDL OT40105 rws | Pure white | 2000 | 118 | 40 | 2 | 48.842 | 6132264 |
| RDL OT40105 cws | Cream | 2000 | 118 | 40 | 2 | 48.842 | 6132190 |

Cover for Rauduo trunking.

Internal corner Rauduo IE40105

PVC

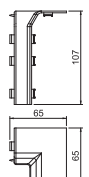

| Type | Colour | Length mm | Width mm | Height mm | Pack Piece | Weight kg/100 pc. | Item no. |
|-----------------------|------------|--------------|-------------|--------------|---------------|----------------------|----------------|
| RD IE40105 rws | Pure white | 107 | 75 | 75 | 10 | 2.400 | 6132280 |
| RD IE40105 cws | Cream | 107 | 75 | 75 | 10 | 2.400 | 6132164 |

Internal corner as a fitting for changing the direction of the Rauduo trunking system.

External corner Rauduo AE40105

PVC

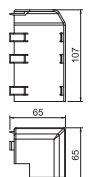

| Type | Colour | Length mm | Width mm | Height mm | Pack Piece | Weight kg/100 pc. | Item no. |
|-----------------------|------------|--------------|-------------|--------------|---------------|----------------------|----------------|
| RD AE40105 rws | Pure white | 107 | 75 | 75 | 10 | 3.400 | 6132165 |
| RD AE40105 cws | Cream | 107 | 75 | 75 | 10 | 3.400 | 6132166 |

External corner as a fitting for changing the direction of the Rauduo trunking system.

PVC



End piece Rauduo ESL40105

| Type | Colour | Length mm | Width mm | Height mm | Pack Piece | Weight kg/100 pc. | Item no. |
|-----------------|------------|--------------|-------------|--------------|---------------|----------------------|----------|
| RD ESL40105 rws | Pure white | 19 | 106 | 42 | 10 | 1.400 | 6132168 |
| RD ESL40105 cws | Cream | 19 | 106 | 42 | 10 | 1.400 | 6132169 |

End piece (left) as a fitting for the Rauduo trunking system.



PVC



End piece Rauduo ESR40105

| Type | Colour | Length mm | Width mm | Height mm | Pack Piece | Weight kg/100 pc. | Item no. |
|-----------------|------------|--------------|-------------|--------------|---------------|----------------------|----------|
| RD ESR40105 rws | Pure white | 19 | 106 | 42 | 10 | 1.400 | 6132285 |
| RD ESR40105 cws | Cream | 19 | 106 | 42 | 10 | 1.400 | 6132167 |

End piece (right) as a fitting for the Rauduo trunking system.



Trunking coupling Rauduo Kup40105

PVC

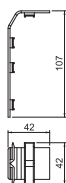

| Type | Colour | Length mm | Width mm | Height mm | Pack Piece | Weight kg/100 pc. | Item no. |
|------------------------|------------|--------------|-------------|--------------|---------------|----------------------|----------------|
| RD KUP40105 rws | Pure white | 107 | 42 | 42 | 10 | 1.300 | 6132176 |
| RD KUP40105 cws | Cream | 107 | 42 | 42 | 10 | 1.300 | 6132177 |

Trunking coupling for connecting the skirting trunking.

Heating pipe support Rauduo HRT 2 20

PA

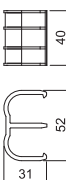

| Type | Length mm | Width mm | Height mm | Pack Piece | Weight kg/100 pc. | Item no. |
|------------------------|--------------|-------------|--------------|---------------|----------------------|----------------|
| RD DUO HRT 2 20 | 52 | 32 | 40 | 10 | 1.500 | 6132170 |

Heating pipe support for guiding a universal pipe in the Rauduo trunking system.

Insulating foam Rauduo ISO

PS

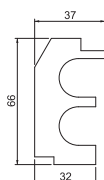

| Type | Length mm | Width mm | Height mm | Pack Piece | Weight kg/100 pc. | Item no. |
|-------------------|--------------|-------------|--------------|---------------|----------------------|----------------|
| RD DUO ISO | 200 | 66 | 38 | 1 | 0.850 | 6132175 |

Insulating foam for the Rauduo trunking system.

Device tank Rauduo GT40105, single

PVC

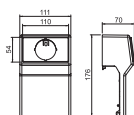

| Type | Colour | Length mm | Width mm | Height mm | Pack Piece | Weight kg/100 pc. | Item no. |
|-----------------------|------------|--------------|-------------|--------------|---------------|----------------------|----------------|
| RD GT40105 rws | Pure white | 62 | 112 | 175 | 1 | 18.000 | 6132173 |
| RD GT40105 cws | Cream | 62 | 112 | 175 | 1 | 15.100 | 6132174 |

Device support for the Rauduo skirting trunking system for the installation of devices in support clamp form (according to DIN 49075).

Device tank Rauduo GT40105, double

PVC

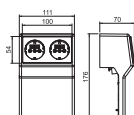

| Type | Colour | Length mm | Width mm | Height mm | Pack Piece | Weight kg/100 pc. | Item no. |
|------------------------|------------|--------------|-------------|--------------|---------------|----------------------|----------------|
| RD 2GT40105 rws | Pure white | 62 | 112 | 175 | 1 | 17.400 | 6132171 |
| RD 2GT40105 cws | Cream | 62 | 112 | 175 | 1 | 17.400 | 6132172 |

Device tank with double Schuko socket for the Rauduo trunking system.

PVC



Device tank RD 2GT40105, double

| Type | Colour | Length mm | Width mm | Height mm | Pack Piece | Weight kg/100 pc. | Item no. |
|------------------|------------|--------------|-------------|--------------|---------------|----------------------|----------|
| RD 2GTK40105 rws | Pure white | 62 | 112 | 175 | 1 | 17.400 | 6132304 |

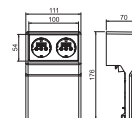

Device tank with double Schuko socket for the Rauduo trunking system.

Floor trunking, type 2650

PVC

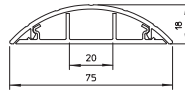





| Type | Colour | Length mm | Pack m | Weight kg/100 m | Item no. |
|------|------------|--------------|-----------|--------------------|----------|
| 2650 | Stone grey | 2000 | 2 | 43.000 | 6020801 |

Trunking cover and base with base perforation.



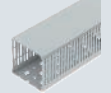

Wiring trunking

| | | |
|--|------------------------------|-----|
|  | LK4 wiring trunking | 204 |
|  | LK4H wiring trunking | 226 |
|  | LKV wiring trunking | 234 |
|  | LKV/H wiring trunking | 244 |
|  | Accessories, wiring trunking | 248 |
|  | Wiring trunking VF | 254 |



Precise measurements and tested quality

An exceptionally large range of products in the usual high quality: Wiring trunking ensures tidy wiring in a switchgear cabinet. All the trunking is made from lead-free material. And, for optimum safety, a selection of halogen-free trunking is available from our range.

Four systems are available for professional wiring installations, which can fulfil any requirements the switchgear cabinet constructor might have. A soft, burr-free slot and rounded tabs make the installation easier and also prevent injuries. Upon request, we can also offer special designs.

The LK4 and LK4/N as well as the LKV and LKV/N trunking systems have exactly predetermined points for easy breaking-out of the side retainers. All the types have, depending on their size, single or dual track perforation to their base. Tapering in the side slots of the LK4/N and LKV/N types prevents the cables from falling out.

LK4 – nominal dimensions are internal dimensions
LKV – only external dimensions



LK4 and LK4/N



With the LK4 and LK4/N systems, OBO can offer a classic wiring trunking with 21 established metric dimensions from 15 x 15 mm to 80 x 120 mm. Precise processing enables simple attaching and detaching of the cover while, at the same time, ensuring a firm fit.

LKV and LKV/N



The LKV and LKV/N systems are termed DIN trunking, as their dimensions correspond to the old DIN standard 43659. Seventeen different dimensions from 25 x 25 mm to 100 x 100 mm are available.

Certified

The wiring trunking is VDE-tested and UL-listed (UL file E301798).

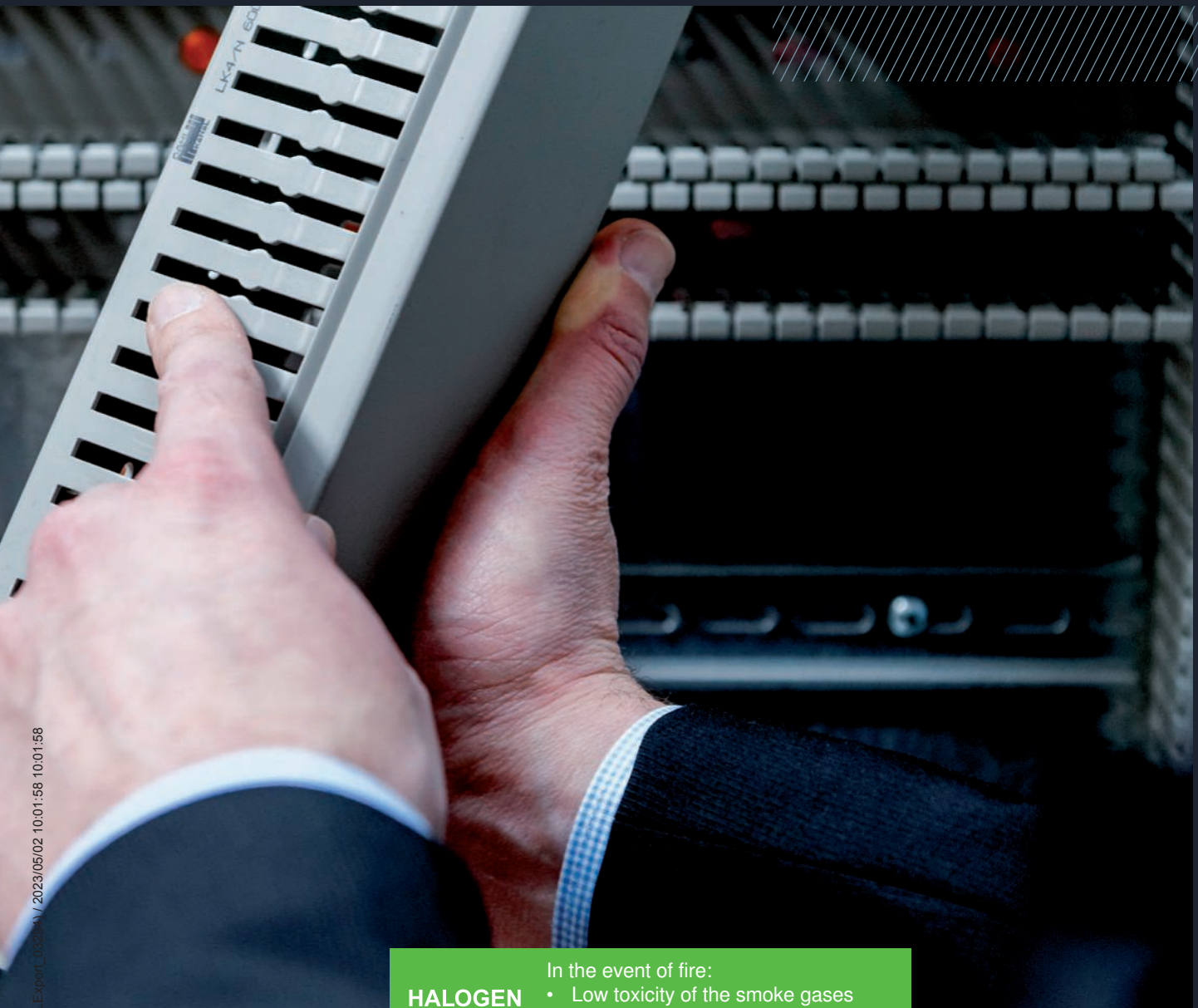

HALOGEN FREE

In the event of fire:

- Low toxicity of the smoke gases
- Scarcely any release of corrosive gases

LK4H

The LK4H wiring trunking is also available as a halogen-free version. The halogen-free version is available in dimensions from 30 x 30 mm to 100 x 100 mm and can fulfil any size requirements.



LKV/H

The LKV/H wiring trunking is halogen-free and available in eight different sizes from 50 x 37.5 mm to 75 x 125 mm.

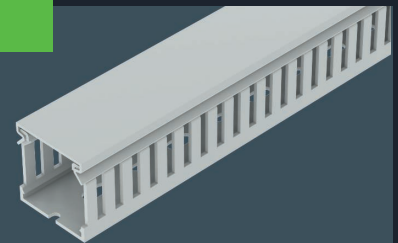

Modular system

Wiring trunking

OBO wiring trunking stands out through a wide range of benefits which have long proven their worth in switchgear cabinet construction. Even in continuous operation, it guarantees secure connections and the reliable function of the electrical infrastructure.



Special solutions

The starting dimension of the base perforation can be adjusted variably

- Available without base perforation
- Special lengths
- Special colours

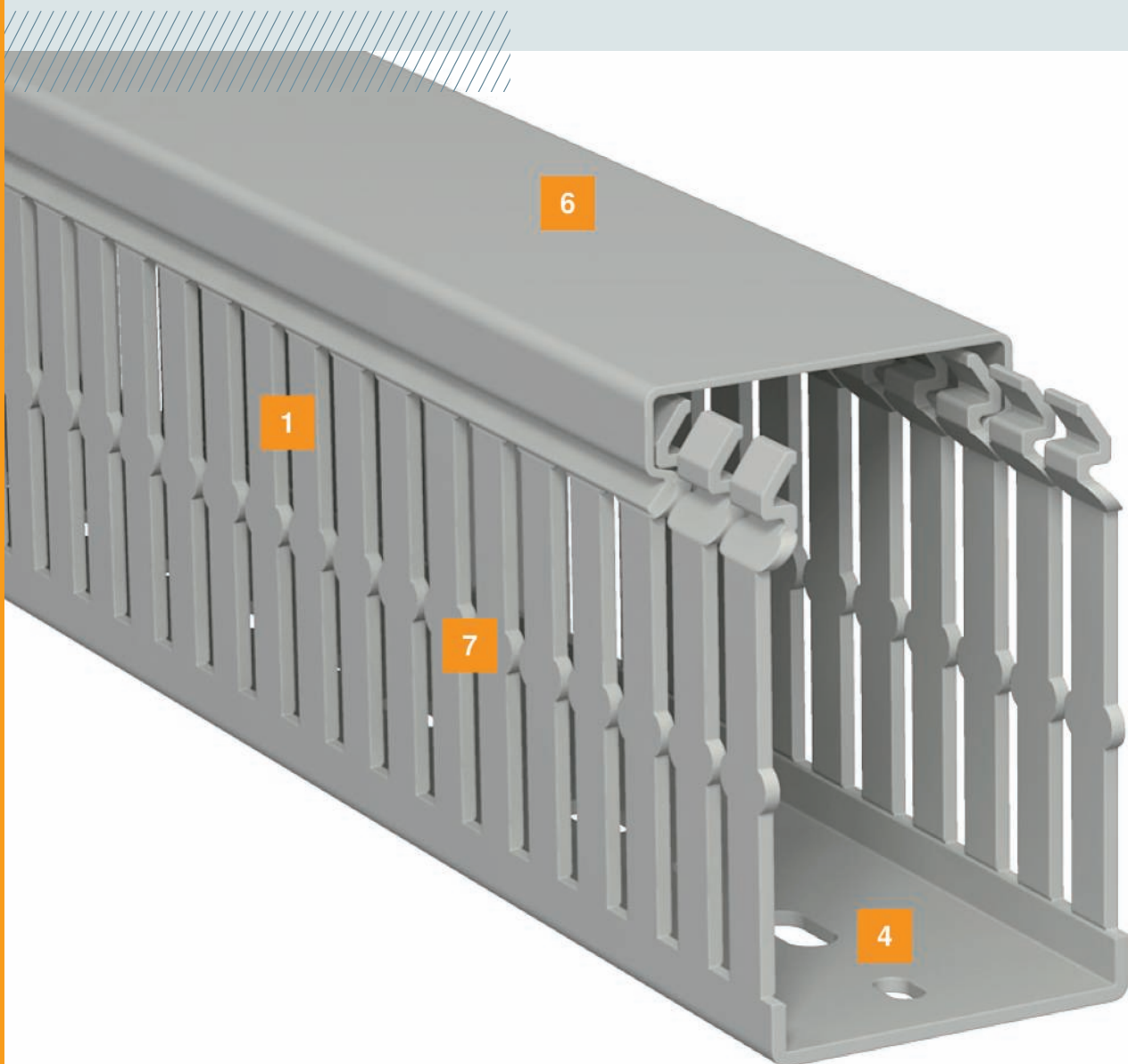

| | |
|---|--|
| 1 | Stable trunking with high-quality thicknesses |
| 2 | Exact predetermined breaking points in the strut and base area |
| 3 | Soft, burr-free slot, rounded tabs |
| 4 | Absolute dimensional accuracy of the side perforation and base perforation |
| 5 | Cut edges rounded and deburred in the closing area |
| 6 | Secure positioning of the covers through optimum closing contours |
| 7 | Wire retaining lug, allowing wiring without wire retaining brackets and preventing previously run-out wires from falling out |



All the trunking systems correspond to the requirements of EN 50085-2-3 and are UL-listed.

LK4 and LK4/N UL file E301798

LKV, LKV/N and LKVH UL file E301798

LK4H UL ML file E523202



Mounting benefits

Mounting of the wiring trunking

The wiring trunking is fastened to the mounting plate of the switchgear cabinet using spreading rivets. The spreading rivets are installed using the plastic riveting tool.



Spacer mounting

Through the mounting on spacers, it is possible to install the wiring trunking with a distance to the mounting plate.

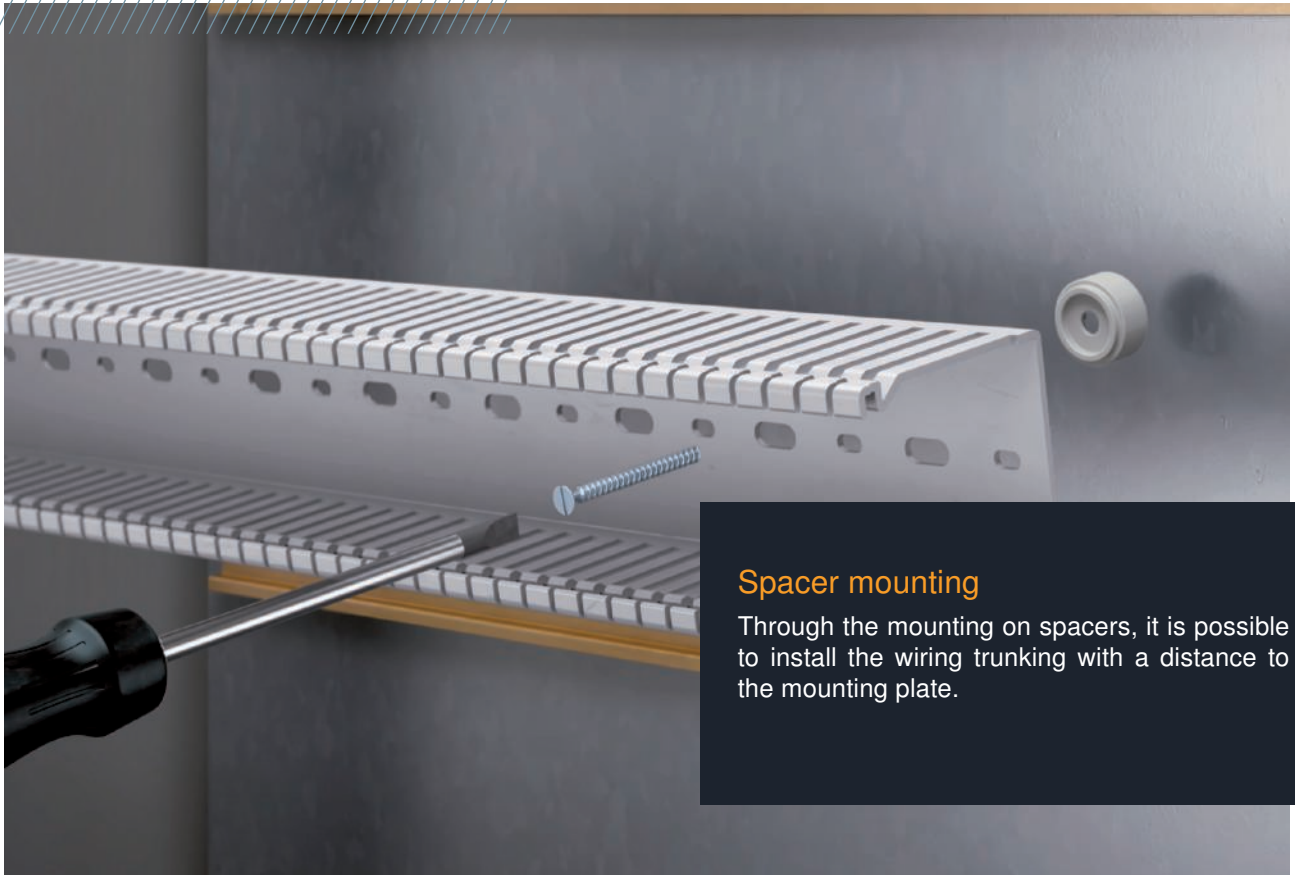

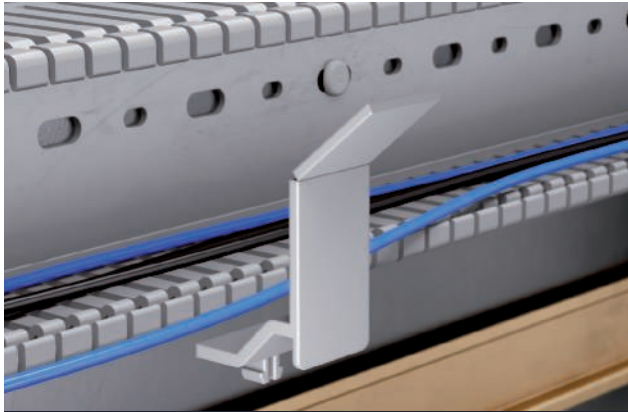

Wire retainers

The wire retainers can be adjusted according to the trunking width. To do this, simply break off the wire retainer at the predetermined breaking points. This means that just one wire retainer is necessary for any trunking width.



Wire retainer mounting

The wire retainer is inserted into the side slot of the wiring trunking. This simplifies cable installation and keeps the cables in place in the wiring trunking. It also guarantees easy attachment of the cover. If installations are required at a later date, then, when the cover is removed, the cables are held in the trunking and do not fall out.



Base perforation

Single and dual-track base perforation to EN 50085-2-3 enable precise work.



Identification plate

Sticker as an identification plate to attach onto wiring trunking in switchgear cabinets with self-protected power circuits.



Hole patterns and dimensions

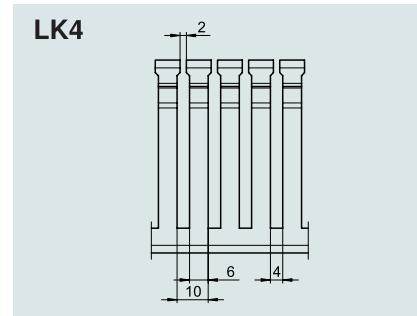
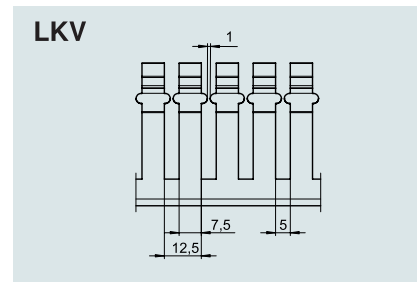
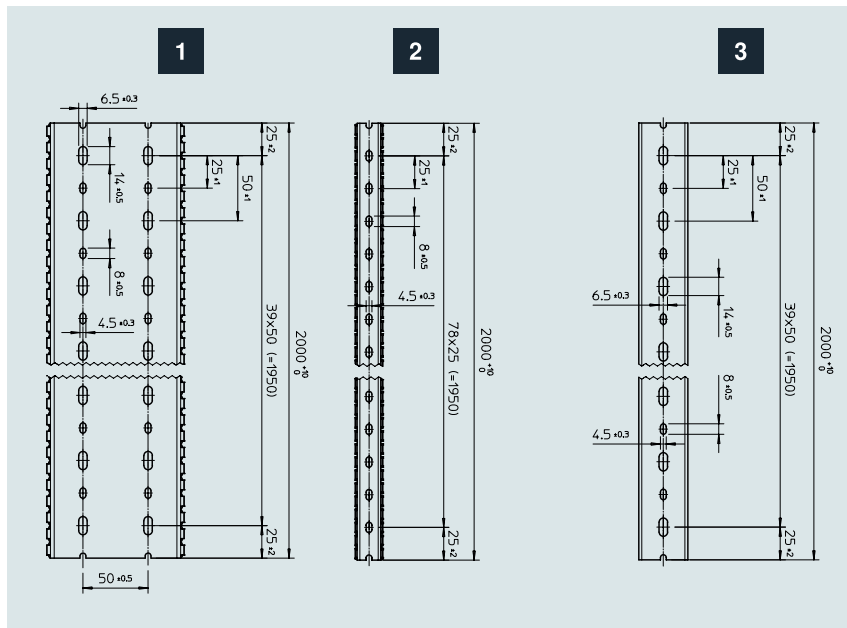

All the VK and VKH wiring trunking always start and finish – with regards to one delivery length (2,000 mm) – with half a small fastening hole (4.5 x 8 mm).

| LK4/LK4/N | Item no. | Hole pattern |
|-------------|----------|--------------|
| LK4 15015 | 6178001 | 2 |
| LK4 30015 | 6178003 | 2 |
| LK4 30025 | 6178005 | 3 |
| LK4 40025 | 6178010 | 3 |
| LK4 40040 | 6178012 | 3 |
| LK4 40060 | 6178014 | 3 |
| LK4 40080 | 6178016 | 1 |
| LK4 40100 | 6178018 | 1 |
| LK4 60015 | 6178026 | 2 |
| LK4/N 60015 | 6178201 | 2 |
| LK4 60025 | 6178028 | 3 |
| LK4/N 60025 | 6178203 | 3 |
| LK4 60040 | 6178031 | 3 |
| LK4/N 60040 | 6178205 | 3 |
| LK4 60060 | 6178033 | 3 |
| LK4/N 60060 | 6178207 | 3 |
| LK4 60080 | 6178035 | 1 |
| LK4/N 60080 | 6178209 | 1 |
| LK4 60100 | 6178037 | 1 |
| LK4/N 60100 | 6178211 | 1 |
| LK4 60120 | 6178039 | 1 |
| LK4/N 60120 | 6178213 | 1 |

| LK4/LK4/N | Item no. | Hole pattern |
|-------------|----------|--------------|
| LK4 80025 | 6178050 | 3 |
| LK4/N 80025 | 6178225 | 3 |
| LK4 80040 | 6178052 | 3 |
| LK4/N 80040 | 6178227 | 3 |
| LK4 80060 | 6178054 | 3 |
| LK4/N 80060 | 6178229 | 3 |
| LK4 80080 | 6178056 | 1 |
| LK4/N 80080 | 6178231 | 1 |
| LK4 80100 | 6178059 | 1 |
| LK4/N 80100 | 6178233 | 1 |
| LK4/N 80120 | 6178236 | 1 |
| LK4/N 80120 | 6178236 | 1 |
| LK4/N 80120 | 6178236 | 1 |

| LKV/H | Item no. | Hole pattern |
|--------------|----------|--------------|
| LKVH 50037 | 6178612 | 3 |
| LKV/H 50050 | 6178614 | 3 |
| LKV/H 50075 | 6178616 | 1 |
| LKVH N 75037 | 6178622 | 3 |
| LKV/H 75050 | 6178624 | 3 |
| LKV/H 75075 | 6178626 | 1 |
| LKV/H 75100 | 6178628 | 1 |
| LKV/H 75125 | 6178630 | 1 |

| LKV/LKV/N | Item no. | Hole pattern |
|-----------|----------|--------------|
| LKV 25025 | 6178302 | 3 |
| LKV 37025 | 6178305 | 3 |
| LKV 37037 | 6178307 | 3 |
| LKV 50025 | 6178310 | 3 |
| LKV 50037 | 6178312 | 3 |
| LKV 50050 | 6178314 | 3 |
| LKV 50075 | 6178316 | 1 |

| LKV/LKV/N | Item no. | Hole pattern |
|-------------|----------|--------------|
| LKV 75025 | 6178320 | 3 |
| LKV/N 75025 | 6178420 | 3 |
| LKV 75037 | 6178322 | 3 |
| LKV/N 75037 | 6178422 | 3 |
| LKV 75050 | 6178324 | 3 |
| LKV/N 75050 | 6178424 | 3 |
| LKV 75075 | 6178326 | 1 |
| LKV/N 75075 | 6178426 | 1 |
| LKV 75100 | 6178328 | 1 |
| LKV/N 75100 | 6178428 | 1 |
| LKV 75125 | 6178330 | 1 |
| LKV/N 75125 | 6178430 | 1 |
| LKV 10037 | 6178334 | 3 |
| LKV/N 10037 | 6178435 | 3 |
| LKV 10050 | 6178336 | 3 |
| LKV/N 10050 | 6178437 | 3 |
| LKV 10075 | 6178338 | 1 |
| LKV/N 10075 | 6178439 | 1 |
| LKV 100100 | 6178341 | 1 |

Dimensions, LK4 wiring trunking

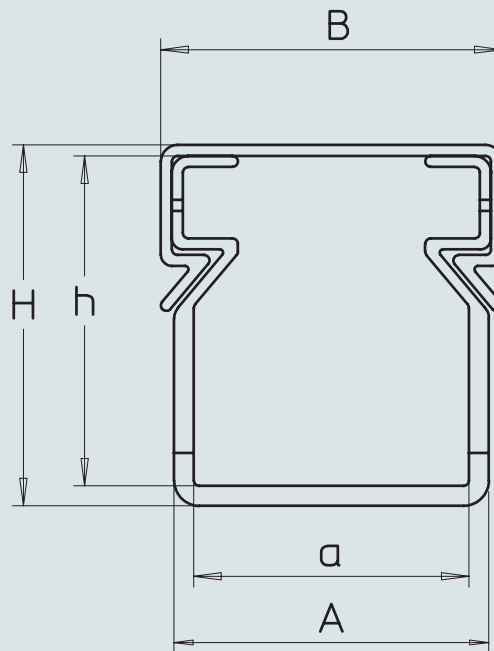

LK4- Nominal dimension = Internal dimension

Dimensions LK4

| Item no. | Type | Item no. | Type | Dimension a mm | Dimension A mm | Dimension B mm | Dimension h mm | Dimension H mm |
|----------|-----------|----------|-------------|----------------|----------------|----------------|----------------|----------------|
| 6178001 | LK4 15015 | | | 15 | 17 | 20 | 15 | 17 |
| 6178003 | LK4 30015 | | | 15 | 17.8 | 20 | 30 | 32.4 |
| 6178005 | LK4 30025 | | | 25 | 28.6 | 31 | 30 | 32.8 |
| 6178010 | LK4 40025 | | | 25 | 28.6 | 31 | 40 | 42.8 |
| 6178012 | LK4 40040 | | | 40 | 43.6 | 46.2 | 40 | 43 |
| 6178014 | LK4 40060 | | | 60 | 64 | 66.4 | 40 | 43.2 |
| 6178016 | LK4 40080 | | | 80 | 84 | 87 | 40 | 43.5 |
| 6178018 | LK4 40100 | | | 100 | 104 | 107.4 | 40 | 43.7 |
| 6178026 | LK4 60015 | 6178201 | LK4 N 60015 | 15 | 18.6 | 20 | 60 | 62.8 |
| 6178028 | LK4 60025 | 6178203 | LK4 N 60025 | 25 | 29 | 31 | 60 | 63 |
| 6178031 | LK4 60040 | 6178205 | LK4 N 60040 | 40 | 44 | 46.2 | 60 | 63 |
| 6178033 | LK4 60060 | 6178207 | LK4 N 60060 | 60 | 64 | 66.4 | 60 | 63.2 |
| 6178035 | LK4 60080 | 6178209 | LK4 N 60080 | 80 | 84.4 | 87 | 60 | 63.7 |
| 6178037 | LK4 60100 | 6178211 | LK4 N 60100 | 100 | 104.6 | 107.4 | 60 | 64 |
| 6178039 | LK4 60120 | 6178213 | LK4 N 60120 | 120 | 124.6 | 127.8 | 60 | 64.2 |
| 6178050 | LK4 80025 | 6178225 | LK4 N 80025 | 25 | 29.4 | 31 | 80 | 83.2 |
| 6178052 | LK4 80040 | 6178227 | LK4 N 80040 | 40 | 44.4 | 46.2 | 80 | 83.3 |
| 6178054 | LK4 80060 | 6178229 | LK4 N 80060 | 60 | 64.4 | 66.4 | 80 | 83.4 |
| 6178056 | LK4 80080 | 6178231 | LK4 N 80080 | 80 | 84.6 | 87 | 80 | 83.9 |
| 6178059 | LK4 80100 | 6178233 | LK4 N 80100 | 100 | 104.8 | 107.4 | 80 | 84.1 |
| 6178061 | LK4 80120 | 6178236 | LK4 N 80120 | 120 | 124.8 | 127.8 | 80 | 84.3 |

Dimensions, LKV and LKVH wiring trunking

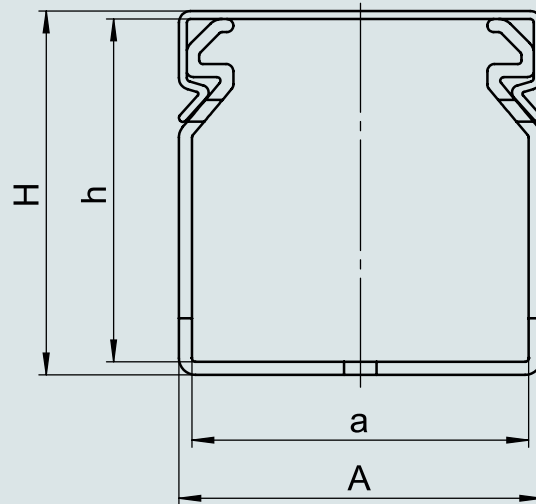

LKV- LKVH- Nominal dimension = External dimension

Dimensions, LKV

| Item no. | Type | Item no. | Type | Dimension a mm | Dimension A mm | Dimension h mm | Dimension H mm |
|----------|------------|----------|--------------|----------------|----------------|----------------|----------------|
| 6178302 | LKV 25025 | | | 21.4 | 25.0 | 22.2 | 25.0 |
| 6178305 | LKV 37025 | | | 21.4 | 25.0 | 34.7 | 1.3 |
| 6178307 | LKV 37037 | | | 33.9 | 1.3 | 34.7 | 1.3 |
| 6178310 | LKV 50025 | | | 21.4 | 25.0 | 47.2 | 50.0 |
| 6178312 | LKV 50037 | | | 33.9 | 1.3 | 47.2 | 50.0 |
| 6178314 | LKV 50050 | | | 46.4 | 50.0 | 47.3 | 50.1 |
| 6178316 | LKV 50075 | | | 71.0 | 75.0 | 47.2 | 50.6 |
| 6178320 | LKV 75025 | 6178420 | LKV N 75025 | 21.0 | 25.0 | 71.4 | 74.4 |
| 6178322 | LKV 75037 | 6178422 | LKV N 75037 | 33.3 | 1.3 | 71.4 | 74.5 |
| 6178324 | LKV 75050 | 6178424 | LKV N 75050 | 45.6 | 50.0 | 71.4 | 74.7 |
| 6178326 | LKV 75075 | 6178426 | LKV N 75075 | 70.6 | 75.0 | 71.4 | 75.0 |
| 6178328 | LKV 75100 | 6178428 | LKV N 75100 | 95.2 | 100.0 | 71.4 | 75.5 |
| 6178330 | LKV 75125 | 6178430 | LKV N 75125 | 120.2 | 125.0 | 71.4 | 75.6 |
| 6178334 | LKV 10037 | 6178435 | LKV N 10037 | 33.1 | 1.3 | 96.2 | 99.4 |
| 6178336 | LKV 10050 | 6178437 | LKV N 10050 | 45.6 | 50.0 | 96.2 | 99.5 |
| 6178338 | LKV 10075 | 6178439 | LKV N 10075 | 70.2 | 75.0 | 96.2 | 100.0 |
| 6178341 | LKV 100100 | 6178441 | LKV N 100100 | 95.2 | 100.0 | 96.2 | 100.3 |

Dimensions, LK4H (N) wiring trunking

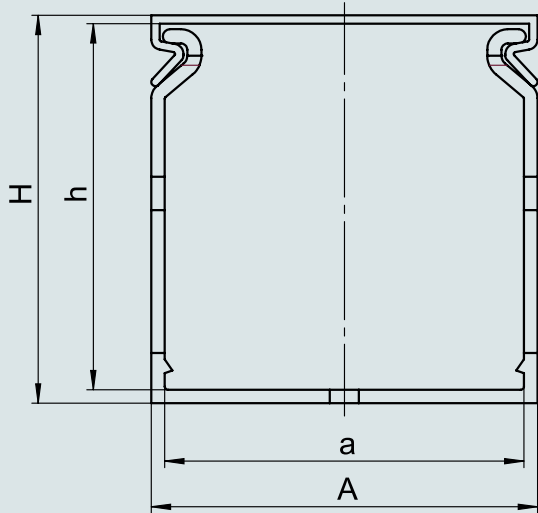

LK4H- Nominal dimension = External dimension

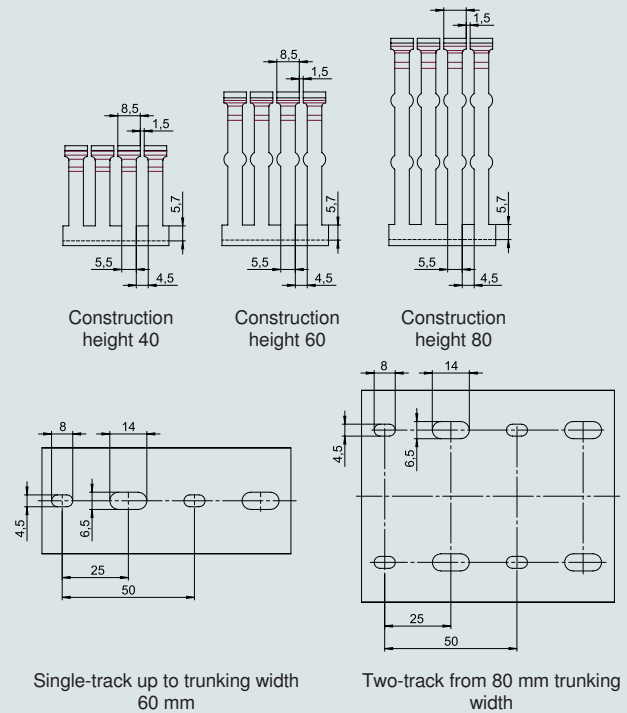

Dimensions, LK4H

| Item no. | Type | Dimension a mm | Dimension A mm | Dimension h mm | Dimension H mm |
|----------|---------------|----------------|----------------|----------------|----------------|
| 6132540 | LK4H 30030 | 26.6 | 30.0 | 27.5 | 30.4 |
| 6132544 | LK4H 40025 | 21.6 | 25.0 | 37.6 | 40.5 |
| 6132546 | LK4H 40040 | 36.4 | 40.0 | 37.4 | 40.5 |
| 6132548 | LK4H 40060 | 56.2 | 60.0 | 37.3 | 40.5 |
| 6132550 | LK4H N 60025 | 21.2 | 25.0 | 57.5 | 60.6 |
| 6132552 | LK4H N 60040 | 36.2 | 40.0 | 57.1 | 60.3 |
| 6132554 | LK4H N 60060 | 55.8 | 60.0 | 56.9 | 60.3 |
| 6132556 | LK4H N 60080 | 75.8 | 80.0 | 56.8 | 60.3 |
| 6132560 | LK4H N 80025 | 20.8 | 25.0 | 76.7 | 80.0 |
| 6132562 | LK4H N 80040 | 35.8 | 40.0 | 76.6 | 80.0 |
| 6132564 | LK4H N 80060 | 55.6 | 60.0 | 76.5 | 80.0 |
| 6132566 | LK4H N 80080 | 75.4 | 80.0 | 76.3 | 80.0 |
| 6132568 | LK4H N 80100 | 95.4 | 100.0 | 76.2 | 80.0 |
| 6132569 | LK4H N 80120 | 115.2 | 120.0 | 76.4 | 80.0 |
| 6132570 | LK4H N 10040 | 35.4 | 40.0 | 96.9 | 100.5 |
| 6132572 | LK4H N 10060 | 55.6 | 60.0 | 96.8 | 100.3 |
| 6132574 | LK4H N 10080 | 75.4 | 80.0 | 96.6 | 100.3 |
| 6132576 | LK4H N 100100 | 95.2 | 100.0 | 96.4 | 100.3 |

Wiring trunking, type LK4 15015

PVC

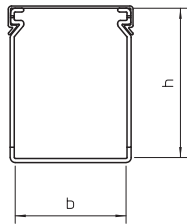
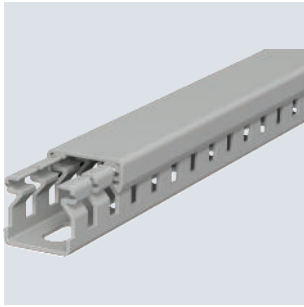

| Type | Colour | Length mm | Dimension | | Pack m | Weight kg/100 m | Item no. |
|-----------|------------|--------------|-------------|--|-----------|--------------------|----------|
| | | | W x H mm | | | | |
| LK4 15015 | Stone grey | 2000 | 15x15 | | 2 | 12.000 | 6178001 |

Wiring trunking including cover and base perforation. The nominal dimension of the system size corresponds to the internal dimension of the trunking. Special lengths on request.

Wiring trunking, type LK4 30015

PVC

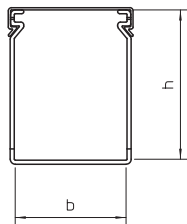
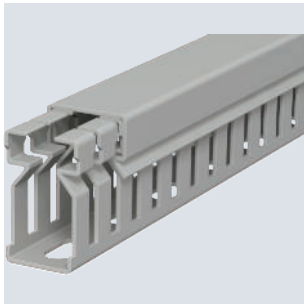

| Type | Colour | Length mm | Dimension | | Pack m | Weight kg/100 m | Item no. |
|-----------|------------|--------------|-------------|--|-----------|--------------------|----------|
| | | | W x H mm | | | | |
| LK4 30015 | Stone grey | 2000 | 15x30 | | 2 | 18.000 | 6178003 |

Wiring trunking including cover and base perforation. The nominal dimension of the system size corresponds to the internal dimension of the trunking. Special lengths on request.

Wiring trunking, type LK4 30025

PVC

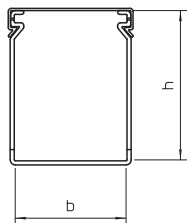
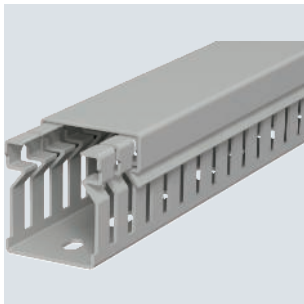

| Type | Colour | Length mm | Dimension | | Pack m | Weight kg/100 m | Item no. |
|-----------|------------|--------------|-------------|--|-----------|--------------------|----------|
| | | | W x H mm | | | | |
| LK4 30025 | Stone grey | 2000 | 25x30 | | 2 | 28.000 | 6178005 |

Wiring trunking including cover and base perforation. The nominal dimension of the system size corresponds to the internal dimension of the trunking. Special lengths on request.

Wiring trunking, type LK4 40025

PVC

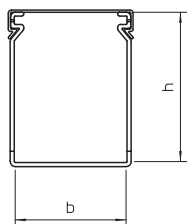
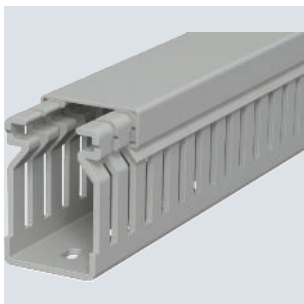

| Type | Colour | Length mm | Dimension | | Pack m | Weight kg/100 m | Item no. |
|-----------|------------|--------------|-------------|--|-----------|--------------------|----------|
| | | | W x H mm | | | | |
| LK4 40025 | Stone grey | 2000 | 25x40 | | 2 | 36.500 | 6178010 |

Wiring trunking including cover and base perforation. The nominal dimension of the system size corresponds to the internal dimension of the trunking. Special lengths on request.

PVC



| Type | Colour | Length mm | Dimension | | Pack m | Weight kg/100 m | Item no. |
|-----------|------------|--------------|-------------|--|-----------|--------------------|----------|
| | | | W x H mm | | | | |
| LK4 40040 | Stone grey | 2000 | 40x40 | | 2 | 44.000 | 6178012 |

Wiring trunking including cover and base perforation. The nominal dimension of the system size corresponds to the internal dimension of the trunking. Special lengths on request.

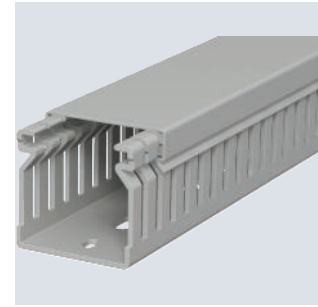
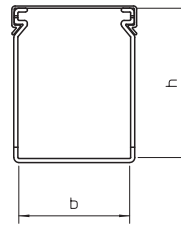

Wiring trunking, type LK4 40060

PVC



| Type | Colour | Length mm | Dimension | | Pack m | Weight kg/100 m | Item no. |
|-----------|------------|--------------|-------------|--|-----------|--------------------|----------|
| | | | W x H mm | | | | |
| LK4 40060 | Stone grey | 2000 | 60x40 | | 2 | 57.000 | 6178014 |

Wiring trunking including cover and base perforation. The nominal dimension of the system size corresponds to the internal dimension of the trunking. Special lengths on request.

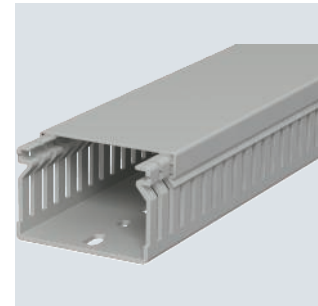
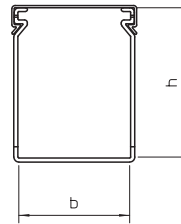

Wiring trunking, type LK4 40080

PVC



| Type | Colour | Length mm | Dimension | | Pack m | Weight kg/100 m | Item no. |
|-----------|------------|--------------|-------------|--|-----------|--------------------|----------|
| | | | W x H mm | | | | |
| LK4 40080 | Stone grey | 2000 | 80x40 | | 2 | 71.000 | 6178016 |

Wiring trunking including cover and base perforation. The nominal dimension of the system size corresponds to the internal dimension of the trunking. Special lengths on request.

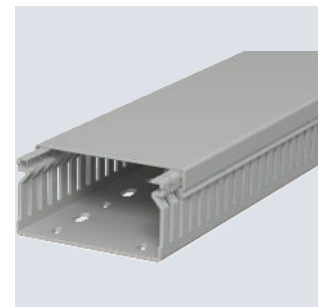
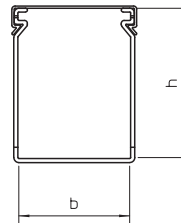

Wiring trunking, type LK4 40100

PVC



| Type | Colour | Length mm | Dimension | | Pack m | Weight kg/100 m | Item no. |
|-----------|------------|--------------|-------------|--|-----------|--------------------|----------|
| | | | W x H mm | | | | |
| LK4 40100 | Stone grey | 2000 | 100x40 | | 2 | 85.500 | 6178018 |

Wiring trunking including cover and base perforation. The nominal dimension of the system size corresponds to the internal dimension of the trunking. Special lengths on request.

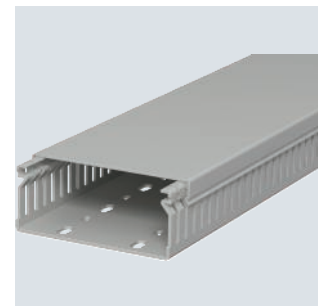
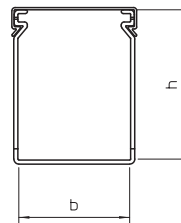

Wiring trunking



Wiring trunking, type LK4 60015

PVC

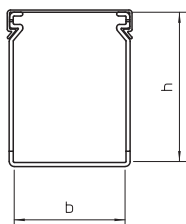

| Type | Colour | Length mm | Dimension | | Pack m | Weight kg/100 m | Item no. |
|-----------|------------|--------------|-------------|--|-----------|--------------------|----------|
| | | | W x H mm | | | | |
| LK4 60015 | Stone grey | 2000 | 15x60 | | 2 | 32.500 | 6178026 |

Wiring trunking including cover and base perforation. The nominal dimension of the system size corresponds to the internal dimension of the trunking. Special lengths on request.

Wiring trunking, type LK4 60025

PVC

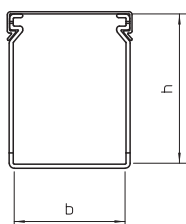
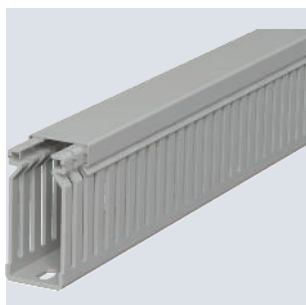

| Type | Colour | Length mm | Dimension | | Pack m | Weight kg/100 m | Item no. |
|-----------|------------|--------------|-------------|--|-----------|--------------------|----------|
| | | | W x H mm | | | | |
| LK4 60025 | Stone grey | 2000 | 25x60 | | 2 | 46.000 | 6178028 |

Wiring trunking including cover and base perforation. The nominal dimension of the system size corresponds to the internal dimension of the trunking. Special lengths on request.

Wiring trunking, type LK4 60040

PVC

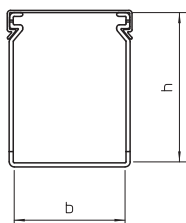
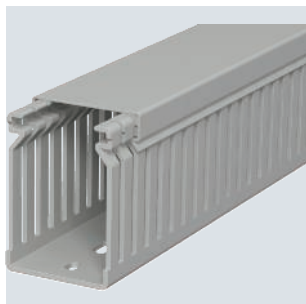

| Type | Colour | Length mm | Dimension | | Pack m | Weight kg/100 m | Item no. |
|-----------|------------|--------------|-------------|--|-----------|--------------------|----------|
| | | | W x H mm | | | | |
| LK4 60040 | Stone grey | 2000 | 40x60 | | 2 | 53.500 | 6178031 |

Wiring trunking including cover and base perforation. The nominal dimension of the system size corresponds to the internal dimension of the trunking. Special lengths on request.

Wiring trunking, type LK4 60060

PVC

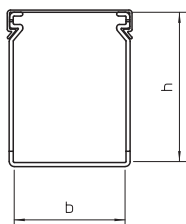
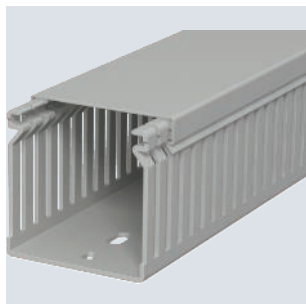

| Type | Colour | Length mm | Dimension | | Pack m | Weight kg/100 m | Item no. |
|-----------|------------|--------------|-------------|--|-----------|--------------------|----------|
| | | | W x H mm | | | | |
| LK4 60060 | Stone grey | 2000 | 60x60 | | 2 | 64.500 | 6178033 |

Wiring trunking including cover and base perforation. The nominal dimension of the system size corresponds to the internal dimension of the trunking. Special lengths on request.

PVC



| Type | Colour | Length mm | Dimension | | Pack m | Weight kg/100 m | Item no. |
|-----------|------------|--------------|-------------|--|-----------|--------------------|----------|
| | | | W x H mm | | | | |
| LK4 60080 | Stone grey | 2000 | 80x60 | | 2 | 82.500 | 6178035 |

Wiring trunking including cover and base perforation. The nominal dimension of the system size corresponds to the internal dimension of the trunking. Special lengths on request.

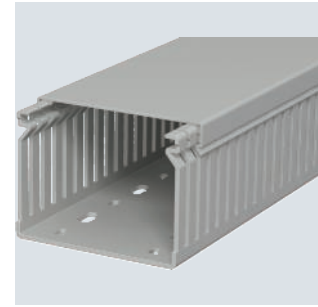
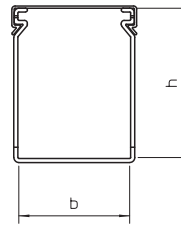

Wiring trunking, type LK4 60080

PVC



| Type | Colour | Length mm | Dimension | | Pack m | Weight kg/100 m | Item no. |
|-----------|------------|--------------|-------------|--|-----------|--------------------|----------|
| | | | W x H mm | | | | |
| LK4 60100 | Stone grey | 2000 | 100x60 | | 2 | 100.000 | 6178037 |

Wiring trunking including cover and base perforation. The nominal dimension of the system size corresponds to the internal dimension of the trunking. Special lengths on request.

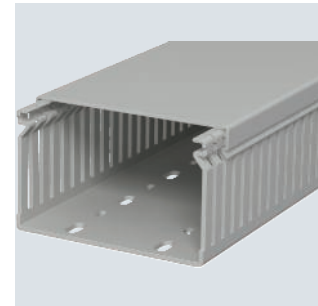
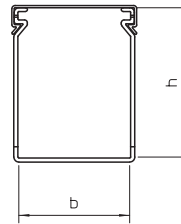

Wiring trunking, type LK4 60100

PVC



| Type | Colour | Length mm | Dimension | | Pack m | Weight kg/100 m | Item no. |
|-----------|------------|--------------|-------------|--|-----------|--------------------|----------|
| | | | W x H mm | | | | |
| LK4 60120 | Stone grey | 2000 | 120x60 | | 2 | 117.000 | 6178039 |

Wiring trunking including cover and base perforation. The nominal dimension of the system size corresponds to the internal dimension of the trunking. Special lengths on request.

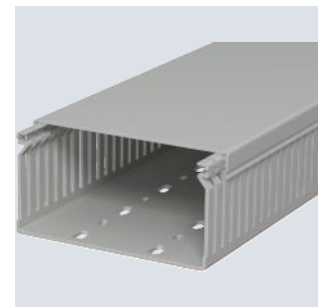
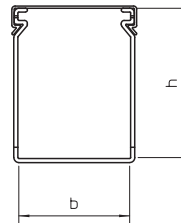

Wiring trunking, type LK4 60120

PVC



| Type | Colour | Length mm | Dimension | | Pack m | Weight kg/100 m | Item no. |
|-----------|------------|--------------|-------------|--|-----------|--------------------|----------|
| | | | W x H mm | | | | |
| LK4 80025 | Stone grey | 2000 | 25x80 | | 2 | 61.000 | 6178050 |

Wiring trunking including cover and base perforation. The nominal dimension of the system size corresponds to the internal dimension of the trunking. Special lengths on request.

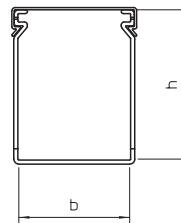

Wiring trunking, type LK4 80025



Wiring trunking, type LK4 80040

PVC

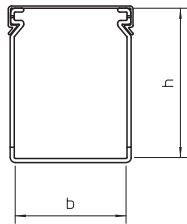
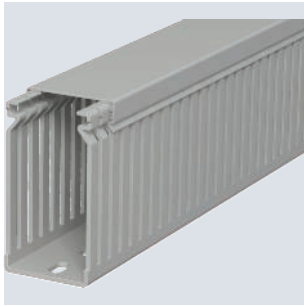

| Type | Colour | Length mm | Dimension | | Pack m | Weight kg/100 m | Item no. |
|-----------|------------|--------------|-------------|--|-----------|--------------------|----------|
| | | | W x H mm | | | | |
| LK4 80040 | Stone grey | 2000 | 40x80 | | 2 | 64.500 | 6178052 |

Wiring trunking including cover and base perforation. The nominal dimension of the system size corresponds to the internal dimension of the trunking. Special lengths on request.

Wiring trunking, type LK4 80060

PVC

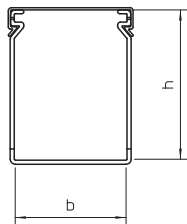
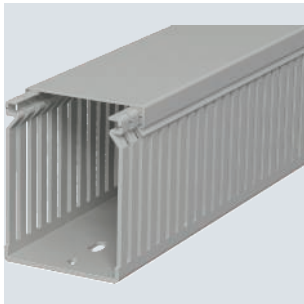

| Type | Colour | Length mm | Dimension | | Pack m | Weight kg/100 m | Item no. |
|-----------|------------|--------------|-------------|--|-----------|--------------------|----------|
| | | | W x H mm | | | | |
| LK4 80060 | Stone grey | 2000 | 60x80 | | 2 | 76.000 | 6178054 |

Wiring trunking including cover and base perforation. The nominal dimension of the system size corresponds to the internal dimension of the trunking. Special lengths on request.

Wiring trunking, type LK4 80080

PVC

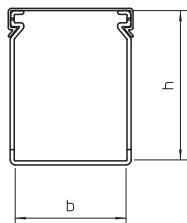
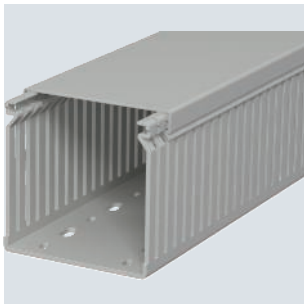

| Type | Colour | Length mm | Dimension | | Pack m | Weight kg/100 m | Item no. |
|-----------|------------|--------------|-------------|--|-----------|--------------------|----------|
| | | | W x H mm | | | | |
| LK4 80080 | Stone grey | 2000 | 80x80 | | 2 | 95.500 | 6178056 |

Wiring trunking including cover and base perforation. The nominal dimension of the system size corresponds to the internal dimension of the trunking. Special lengths on request.

Wiring trunking, type LK4 80100

PVC

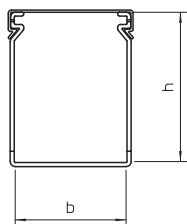
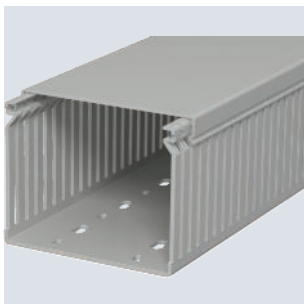

| Type | Colour | Length mm | Dimension | | Pack m | Weight kg/100 m | Item no. |
|-----------|------------|--------------|-------------|--|-----------|--------------------|----------|
| | | | W x H mm | | | | |
| LK4 80100 | Stone grey | 2000 | 100x80 | | 2 | 111.500 | 6178059 |

Wiring trunking including cover and base perforation. The nominal dimension of the system size corresponds to the internal dimension of the trunking. Special lengths on request.

PVC



Wiring trunking, type LK4 80120

| Type | Colour | Length mm | Dimension | | Pack m | Weight kg/100 m | Item no. |
|-----------|------------|--------------|-------------|--|-----------|--------------------|----------|
| | | | W x H mm | | | | |
| LK4 80120 | Stone grey | 2000 | 120x80 | | 2 | 128.500 | 6178061 |

Wiring trunking including cover and base perforation. The nominal dimension of the system size corresponds to the internal dimension of the trunking. Special lengths on request.

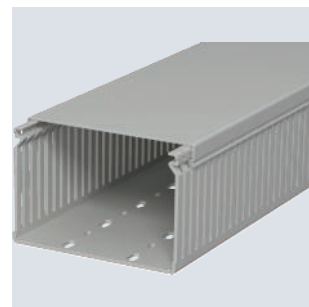
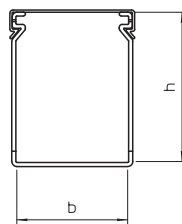

Wiring trunking, type LK4/N 60015

PVC

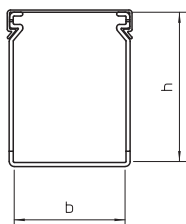

| Type | Colour | Length mm | Dimension | | Pack m | Weight kg/100 m | Item no. |
|-------------|------------|--------------|-------------|--|-----------|--------------------|----------|
| | | | W x H mm | | | | |
| LK4 N 60015 | Stone grey | 2000 | 15x60 | | 2 | 41.000 | 6178201 |

Wiring trunking including cover and base perforation, tapering in the side slots stops the cables from falling out. The nominal dimension of the system size corresponds to the internal dimension of the trunking. Special lengths on request.

Wiring trunking, type LK4/N 60025

PVC

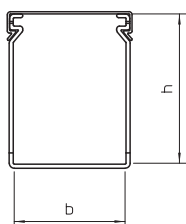
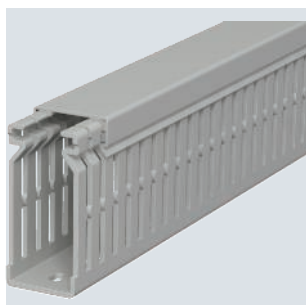

| Type | Colour | Length mm | Dimension | | Pack m | Weight kg/100 m | Item no. |
|-------------|------------|--------------|-------------|--|-----------|--------------------|----------|
| | | | W x H mm | | | | |
| LK4 N 60025 | Stone grey | 2000 | 25x60 | | 2 | 48.500 | 6178203 |

Wiring trunking including cover and base perforation, tapering in the side slots stops the cables from falling out. The nominal dimension of the system size corresponds to the internal dimension of the trunking. Special lengths on request.

Wiring trunking, type LK4/N 60040

PVC

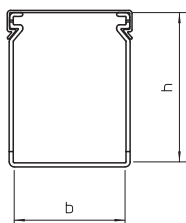
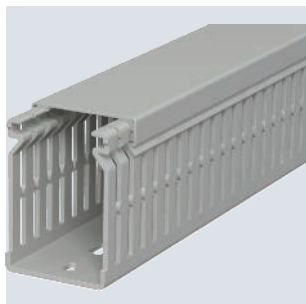

| Type | Colour | Length mm | Dimension | | Pack m | Weight kg/100 m | Item no. |
|-------------|------------|--------------|-------------|--|-----------|--------------------|----------|
| | | | W x H mm | | | | |
| LK4 N 60040 | Stone grey | 2000 | 40x60 | | 2 | 56.000 | 6178205 |

Wiring trunking including cover and base perforation, tapering in the side slots stops the cables from falling out. The nominal dimension of the system size corresponds to the internal dimension of the trunking. Special lengths on request.

Wiring trunking, type LK4/N 60060

PVC

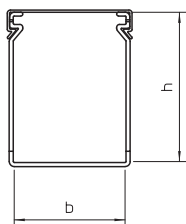
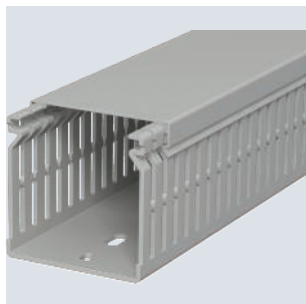

| Type | Colour | Length mm | Dimension | | Pack m | Weight kg/100 m | Item no. |
|-------------|------------|--------------|-------------|--|-----------|--------------------|----------|
| | | | W x H mm | | | | |
| LK4 N 60060 | Stone grey | 2000 | 60x60 | | 2 | 68.000 | 6178207 |

Wiring trunking including cover and base perforation, tapering in the side slots stops the cables from falling out. The nominal dimension of the system size corresponds to the internal dimension of the trunking. Special lengths on request.

PVC



| Type | Colour | Dimension | | Pack | Weight | Item no. |
|-------------|------------|--------------|-------------|------|--------|----------|
| | | Length mm | W x H mm | | | |
| LK4 N 60080 | Stone grey | 2000 | 80x60 | 2 | 87.000 | 6178209 |

Wiring trunking including cover and base perforation, tapering in the side slots stops the cables from falling out. The nominal dimension of the system size corresponds to the internal dimension of the trunking. Special lengths on request.

Wiring trunking, type LK4/N 60080

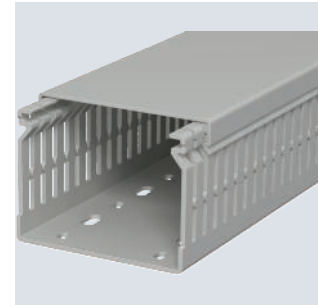
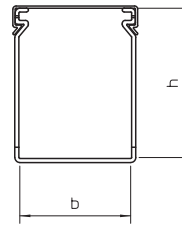

PVC



| Type | Colour | Dimension | | Pack | Weight | Item no. |
|-------------|------------|--------------|-------------|------|---------|----------|
| | | Length mm | W x H mm | | | |
| LK4 N 60100 | Stone grey | 2000 | 100x60 | 16 | 105.500 | 6178211 |

Wiring trunking including cover and base perforation, tapering in the side slots stops the cables from falling out. The nominal dimension of the system size corresponds to the internal dimension of the trunking. Special lengths on request.

Wiring trunking, type LK4/N 60100

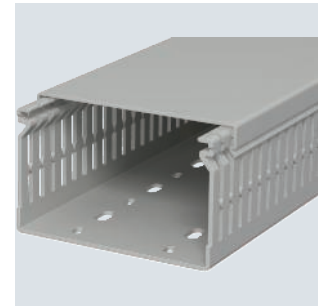
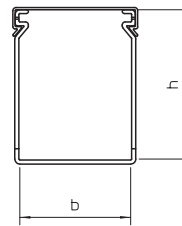

PVC



| Type | Colour | Dimension | | Pack | Weight | Item no. |
|-------------|------------|--------------|-------------|------|---------|----------|
| | | Length mm | W x H mm | | | |
| LK4 N 60120 | Stone grey | 2000 | 120x60 | 8 | 120.500 | 6178213 |

Wiring trunking including cover and base perforation, tapering in the side slots stops the cables from falling out. The nominal dimension of the system size corresponds to the internal dimension of the trunking. Special lengths on request.

Wiring trunking, type LK4/N 60120

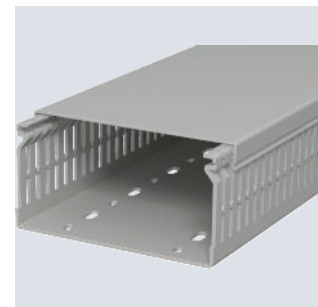
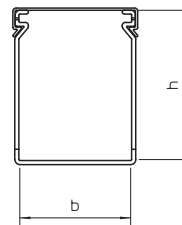

PVC



| Type | Colour | Dimension | | Pack | Weight | Item no. |
|-------------|------------|--------------|-------------|------|--------|----------|
| | | Length mm | W x H mm | | | |
| LK4 N 80025 | Stone grey | 2000 | 25x80 | 2 | 65.000 | 6178225 |

Wiring trunking including cover and base perforation, tapering in the side slots stops the cables from falling out. The nominal dimension of the system size corresponds to the internal dimension of the trunking. Special lengths on request.

Wiring trunking, type LK4/N 80025

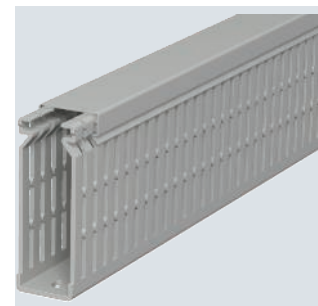
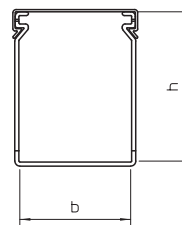

Wiring trunking, type LK4/N 80040

PVC

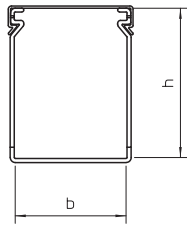
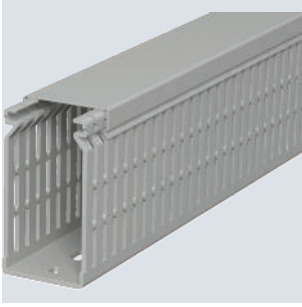

| Type | Colour | Length mm | Dimension | | Pack m | Weight kg/100 m | Item no. |
|-------------|------------|--------------|-------------|--|-----------|--------------------|----------|
| | | | W x H mm | | | | |
| LK4 N 80040 | Stone grey | 2000 | 40x80 | | 2 | 73.500 | 6178227 |

Wiring trunking including cover and base perforation, tapering in the side slots stops the cables from falling out. The nominal dimension of the system size corresponds to the internal dimension of the trunking. Special lengths on request.

Wiring trunking, type LK4/N 80060

PVC

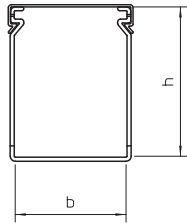
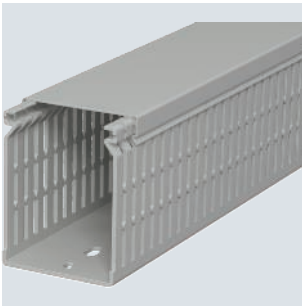

| Type | Colour | Length mm | Dimension | | Pack m | Weight kg/100 m | Item no. |
|-------------|------------|--------------|-------------|--|-----------|--------------------|----------|
| | | | W x H mm | | | | |
| LK4 N 80060 | Stone grey | 2000 | 60x80 | | 2 | 82.000 | 6178229 |

Wiring trunking including cover and base perforation, tapering in the side slots stops the cables from falling out. The nominal dimension of the system size corresponds to the internal dimension of the trunking. Special lengths on request.

Wiring trunking, type LK4/N 80080

PVC

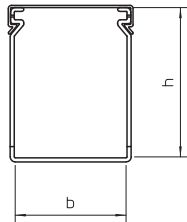
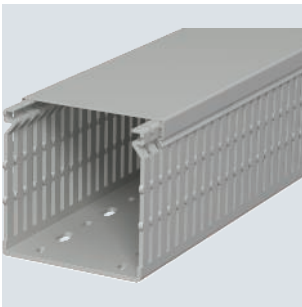

| Type | Colour | Length mm | Dimension | | Pack m | Weight kg/100 m | Item no. |
|-------------|------------|--------------|-------------|--|-----------|--------------------|----------|
| | | | W x H mm | | | | |
| LK4 N 80080 | Stone grey | 2000 | 80x80 | | 2 | 101.000 | 6178231 |

Wiring trunking including cover and base perforation, tapering in the side slots stops the cables from falling out. The nominal dimension of the system size corresponds to the internal dimension of the trunking. Special lengths on request.

Wiring trunking, type LK4/N 80100

PVC

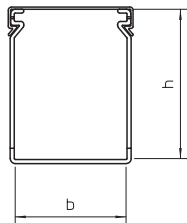
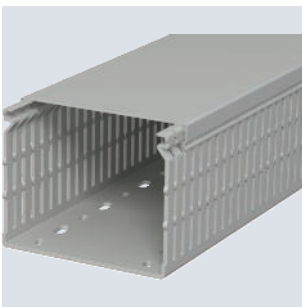

| Type | Colour | Length mm | Dimension | | Pack m | Weight kg/100 m | Item no. |
|-------------|------------|--------------|-------------|--|-----------|--------------------|----------|
| | | | W x H mm | | | | |
| LK4 N 80100 | Stone grey | 2000 | 100x80 | | 2 | 116.500 | 6178233 |

Wiring trunking including cover and base perforation, tapering in the side slots stops the cables from falling out. The nominal dimension of the system size corresponds to the internal dimension of the trunking. Special lengths on request.

PVC



Wiring trunking, type LK4/N 80120

| Type | Colour | Dimension | | Pack m | Weight kg/100 m | Item no. |
|-------------|------------|-----------|----------|--------|-----------------|----------|
| | | Length mm | W x H mm | | | |
| LK4 N 80120 | Stone grey | 2000 | 120x80 | 2 | 133.500 | 6178236 |

Wiring trunking including cover and base perforation, tapering in the side slots stops the cables from falling out. The nominal dimension of the system size corresponds to the internal dimension of the trunking. Special lengths on request.

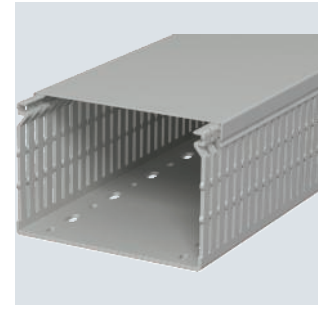
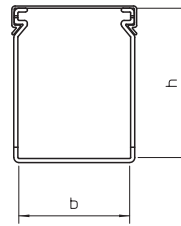

Covers, LK4 wiring ducts

PVC



Cover LK4 D 15

| Type | Colour | Dim. | | Pack m | Weight kg/100 m | Item no. |
|----------|------------|------|-----------|--------|-----------------|----------|
| | | a mm | Length mm | | | |
| LK4 D 15 | Stone grey | 20 | 2000 | 2 | 8.500 | 6178480 |

Trunking cover for replacement requirements.

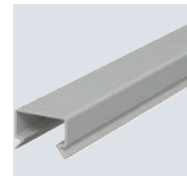
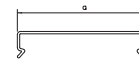

PVC



Cover LK4 D 25

| Type | Colour | Dim. | | Pack m | Weight kg/100 m | Item no. |
|----------|------------|------|-----------|--------|-----------------|----------|
| | | a mm | Length mm | | | |
| LK4 D 25 | Stone grey | 31 | 2000 | 2 | 10.000 | 6178482 |

Trunking cover for replacement requirements.

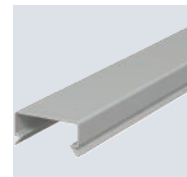
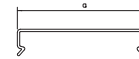

PVC



Cover LK4 D 40

| Type | Colour | Dim. | | Pack m | Weight kg/100 m | Item no. |
|----------|------------|------|-----------|--------|-----------------|----------|
| | | a mm | Length mm | | | |
| LK4 D 40 | Stone grey | 46.2 | 2000 | 2 | 13.500 | 6178484 |

Trunking cover for replacement requirements.

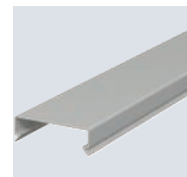
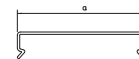

PVC



Cover LK4 D 60

| Type | Colour | Dim. | | Pack m | Weight kg/100 m | Item no. |
|----------|------------|------|-----------|--------|-----------------|----------|
| | | a mm | Length mm | | | |
| LK4 D 60 | Stone grey | 66.4 | 2000 | 2 | 18.000 | 6178486 |

Trunking cover for replacement requirements.

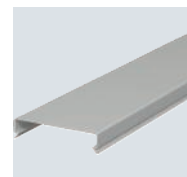
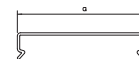

Cover LK4 D 80

PVC

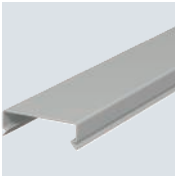

| Type | Colour | Dim. | | Pack | Weight | | Item no. |
|----------|------------|------|--------|------|--------|----------|----------|
| | | a | Length | | m | kg/100 m | |
| LK4 D 80 | Stone grey | 87 | 2000 | 2 | 27.000 | 6178488 | |

Trunking cover for replacement requirements.

Cover LK4 D 100

PVC

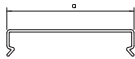
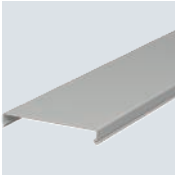

| Type | Colour | Dim. | | Pack | Weight | | Item no. |
|-----------|------------|-------|--------|------|--------|----------|----------|
| | | a | Length | | m | kg/100 m | |
| LK4 D 100 | Stone grey | 107.4 | 2000 | 2 | 35.500 | 6178490 | |

Trunking cover for replacement requirements.

Cover LK4 D 120

PVC

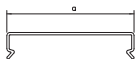
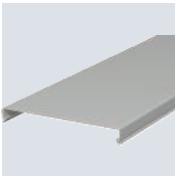

| Type | Colour | Dim. | | Pack | Weight | | Item no. |
|-----------|------------|-------|--------|------|--------|----------|----------|
| | | a | Length | | m | kg/100 m | |
| LK4 D 120 | Stone grey | 127.8 | 2000 | 2 | 45.500 | 6178492 | |

Trunking cover for replacement requirements.



Wiring trunking, type LK4H 30030

PC/
ABS

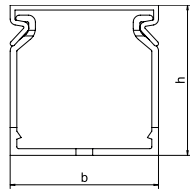

| Type | Colour | Length mm | Width mm | Height mm | Pack m | Weight kg/100 m | Item no. |
|------------|------------|--------------|-------------|--------------|-----------|--------------------|----------|
| LK4H 30030 | Light grey | 2000 | 30 | 30 | 2 | 18.000 | 6132540 |

Wiring trunking, type LK4H 40025

PC/
ABS

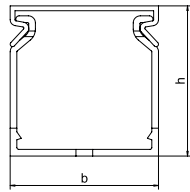
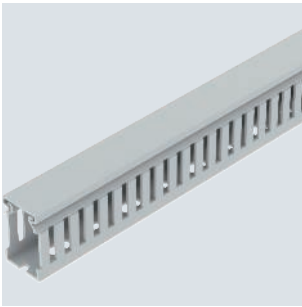

| Type | Colour | Length mm | Width mm | Height mm | Pack m | Weight kg/100 m | Item no. |
|------------|------------|--------------|-------------|--------------|-----------|--------------------|----------|
| LK4H 40025 | Light grey | 2000 | 25 | 40 | 2 | 21.000 | 6132544 |

Wiring trunking, type LK4H 40040

PC/
ABS

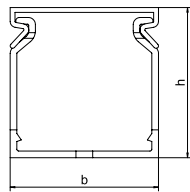
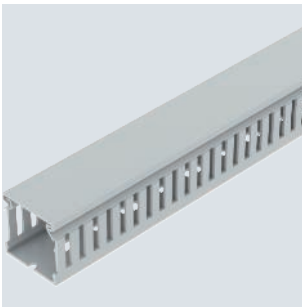

| Type | Colour | Length mm | Width mm | Height mm | Pack m | Weight kg/100 m | Item no. |
|------------|------------|--------------|-------------|--------------|-----------|--------------------|----------|
| LK4H 40040 | Light grey | 2000 | 40 | 40 | 2 | 50.000 | 6132546 |

Wiring trunking, type LK4H 40060

PC/
ABS

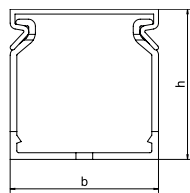
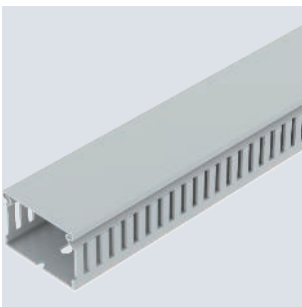

| Type | Colour | Length mm | Width mm | Height mm | Pack m | Weight kg/100 m | Item no. |
|------------|------------|--------------|-------------|--------------|-----------|--------------------|----------|
| LK4H 40060 | Light grey | 2000 | 60 | 40 | 2 | 35.000 | 6132548 |

PC/
ABS



Wiring trunking, type LK4H N 60025

| Type | Colour | Length mm | Width mm | Height mm | Pack m | Weight kg/100 m | Item no. |
|--------------|------------|--------------|-------------|--------------|-----------|--------------------|----------|
| LK4H N 60025 | Light grey | 2000 | 25 | 60 | 2 | 26.000 | 6132550 |

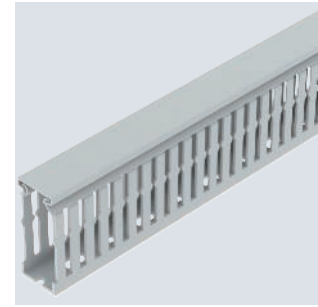
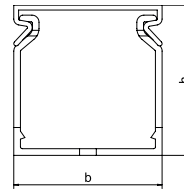

PC/
ABS



Wiring trunking, type LK4H N 60040

| Type | Colour | Length mm | Width mm | Height mm | Pack m | Weight kg/100 m | Item no. |
|--------------|------------|--------------|-------------|--------------|-----------|--------------------|----------|
| LK4H N 60040 | Light grey | 2000 | 40 | 60 | 2 | 35.000 | 6132552 |

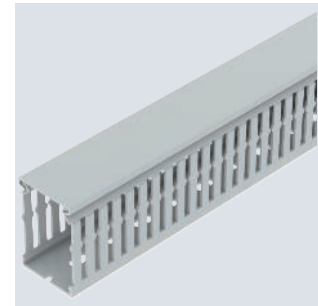
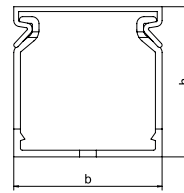

PC/
ABS



Wiring trunking, type LK4H N 60060

| Type | Colour | Length mm | Width mm | Height mm | Pack m | Weight kg/100 m | Item no. |
|--------------|------------|--------------|-------------|--------------|-----------|--------------------|----------|
| LK4H N 60060 | Light grey | 2000 | 60 | 60 | 2 | 42.000 | 6132554 |

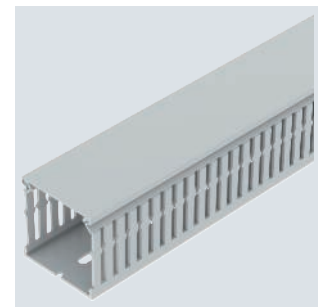
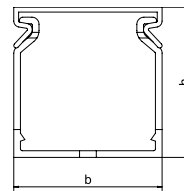

PC/
ABS



Wiring trunking, type LK4H N 60080

| Type | Colour | Length mm | Width mm | Height mm | Pack m | Weight kg/100 m | Item no. |
|--------------|------------|--------------|-------------|--------------|-----------|--------------------|----------|
| LK4H N 60080 | Light grey | 2000 | 80 | 60 | 2 | 52.000 | 6132556 |

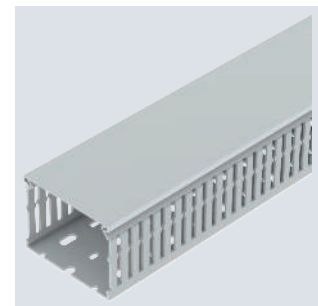
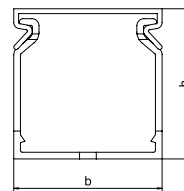

Wiring trunking, type LK4H N 80025

PC/
ABS

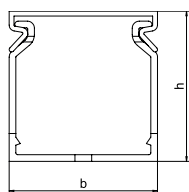

| Type | Colour | Length mm | Width mm | Height mm | Pack m | Weight kg/100 m | Item no. |
|--------------|------------|--------------|-------------|--------------|-----------|--------------------|----------|
| LK4H N 80025 | Light grey | 2000 | 25 | 80 | 2 | 35.000 | 6132560 |

Wiring trunking, type LK4H N 80040

PC/
ABS

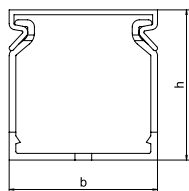
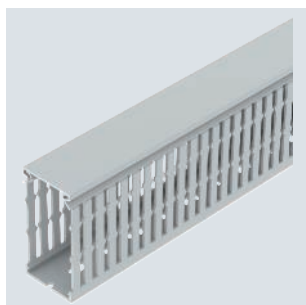

| Type | Colour | Length mm | Width mm | Height mm | Pack m | Weight kg/100 m | Item no. |
|--------------|------------|--------------|-------------|--------------|-----------|--------------------|----------|
| LK4H N 80040 | Light grey | 2000 | 40 | 80 | 2 | 43.000 | 6132562 |

Wiring trunking, type LK4H N 80060

PC/
ABS

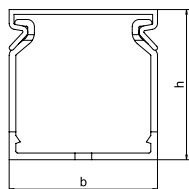
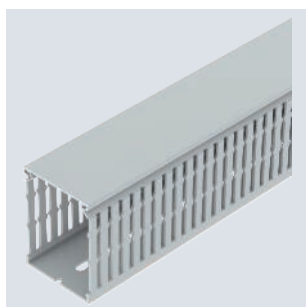

| Type | Colour | Length mm | Width mm | Height mm | Pack m | Weight kg/100 m | Item no. |
|--------------|------------|--------------|-------------|--------------|-----------|--------------------|----------|
| LK4H N 80060 | Light grey | 2000 | 60 | 80 | 2 | 54.000 | 6132564 |

Wiring trunking, type LK4H N 80080

PC/
ABS

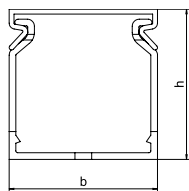
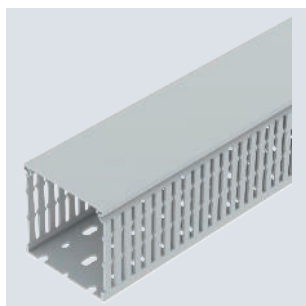

| Type | Colour | Length mm | Width mm | Height mm | Pack m | Weight kg/100 m | Item no. |
|--------------|------------|--------------|-------------|--------------|-----------|--------------------|----------|
| LK4H N 80080 | Light grey | 2000 | 80 | 80 | 2 | 62.000 | 6132566 |

PC/
ABS



Wiring trunking, type LK4H N 80100

| Type | Colour | Length mm | Width mm | Height mm | Pack m | Weight kg/100 m | Item no. |
|--------------|------------|--------------|-------------|--------------|-----------|--------------------|----------|
| LK4H N 80100 | Light grey | 2000 | 100 | 80 | 2 | 67.000 | 6132568 |

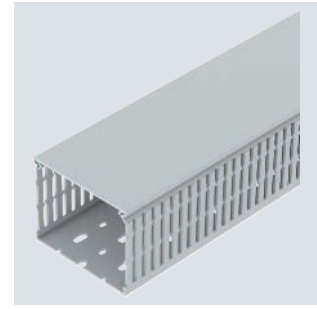
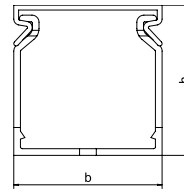

PC/
ABS



Wiring trunking, type LK4H N 80120

| Type | Colour | Length mm | Width mm | Height mm | Pack m | Weight kg/100 m | Item no. |
|--------------|------------|--------------|-------------|--------------|-----------|--------------------|----------|
| LK4H N 80120 | Light grey | 1000 | 120 | 80 | 2 | 80.000 | 6132569 |

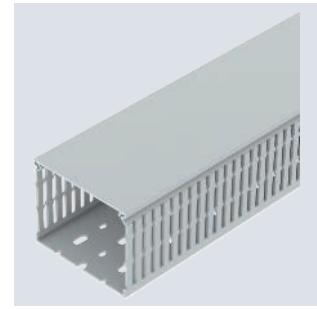
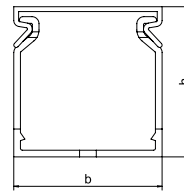

Wiring trunking



Wiring trunking, type LK4H N 10040

PC/
ABS

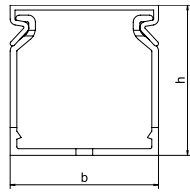

| Type | Colour | Length mm | Width mm | Height mm | Pack m | Weight kg/100 m | Item no. |
|--------------|------------|--------------|-------------|--------------|-----------|--------------------|----------|
| LK4H N 10040 | Light grey | 2000 | 40 | 100 | 2 | 90.000 | 6132570 |

Wiring trunking, type LK4H N 10060

PC/
ABS

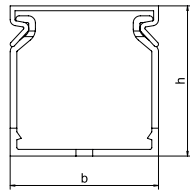
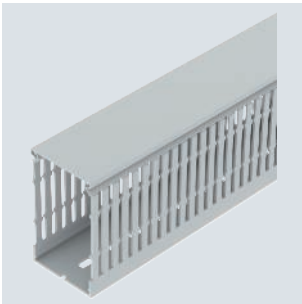

| Type | Colour | Length mm | Width mm | Height mm | Pack m | Weight kg/100 m | Item no. |
|--------------|------------|--------------|-------------|--------------|-----------|--------------------|----------|
| LK4H N 10060 | Light grey | 2000 | 60 | 100 | 2 | 66.000 | 6132572 |

Wiring trunking, type LK4H N 10080

PC/
ABS

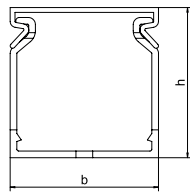
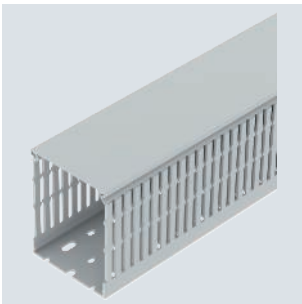

| Type | Colour | Length mm | Width mm | Height mm | Pack m | Weight kg/100 m | Item no. |
|--------------|------------|--------------|-------------|--------------|-----------|--------------------|----------|
| LK4H N 10080 | Light grey | 2000 | 80 | 100 | 2 | 90.000 | 6132574 |

Wiring trunking, type LK4H N 100100

PC/
ABS

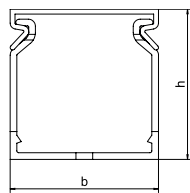
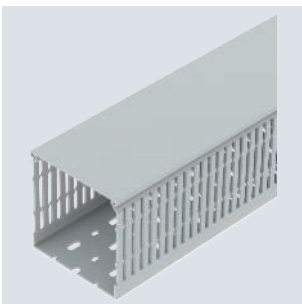

| Type | Colour | Length mm | Width mm | Height mm | Pack m | Weight kg/100 m | Item no. |
|---------------|------------|--------------|-------------|--------------|-----------|--------------------|----------|
| LK4H N 100100 | Light grey | 2000 | 100 | 100 | 2 | 90.000 | 6132576 |

PC/
ABS



Cover LK4H 25

| Type | Colour | Length mm | Width mm | Height mm | Pack m | Weight kg/100 m | Item no. |
|-----------|------------|--------------|-------------|--------------|-----------|--------------------|----------|
| LK4H D 25 | Light grey | 2000 | 25 | 10 | 2 | 8.000 | 6132580 |

Trunking cover for replacement requirements.

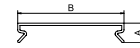

PC/
ABS



Cover LK4H 40

| Type | Colour | Length mm | Width mm | Height mm | Pack m | Weight kg/100 m | Item no. |
|-----------|------------|--------------|-------------|--------------|-----------|--------------------|----------|
| LK4H D 40 | Light grey | 2000 | 40 | 10 | 2 | 13.000 | 6132585 |

Trunking cover for replacement requirements.

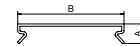

PC/
ABS



Cover LK4H 60

| Type | Colour | Length mm | Width mm | Height mm | Pack m | Weight kg/100 m | Item no. |
|-----------|------------|--------------|-------------|--------------|-----------|--------------------|----------|
| LK4H D 60 | Light grey | 2000 | 60 | 10 | 2 | 20.000 | 6132582 |

Trunking cover for replacement requirements.

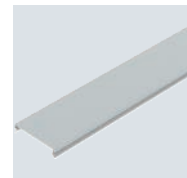
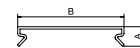

PC/
ABS



Cover LK4H 80

| Type | Colour | Length mm | Width mm | Height mm | Pack m | Weight kg/100 m | Item no. |
|-----------|------------|--------------|-------------|--------------|-----------|--------------------|----------|
| LK4H D 80 | Light grey | 2000 | 80 | 10 | 2 | 26.000 | 6132584 |

Trunking cover for replacement requirements.

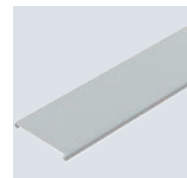
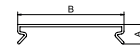

PC/
ABS



Cover LK4H 100

| Type | Colour | Length mm | Width mm | Height mm | Pack m | Weight kg/100 m | Item no. |
|------------|------------|--------------|-------------|--------------|-----------|--------------------|----------|
| LK4H D 100 | Light grey | 2000 | 100 | 10 | 2 | 30.000 | 6132586 |

Trunking cover for replacement requirements.

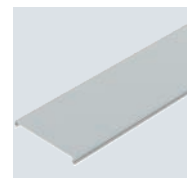
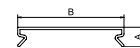

Trunking retaining clip VDK HF KHUni

PC/
ABS



| Type | Colour | Length mm | Width mm | Height mm | Pack Piece | Weight kg/100 pc. | Item no. |
|------|------------|--------------|-------------|--------------|---------------|----------------------|----------|
| VKHK | Light grey | 76 | 20 | 22 | 25 | 0.500 | 6132594 |

Wire retaining clip for HF-METRA wiring trunking.



Wiring trunking, type LKV 25025

PVC

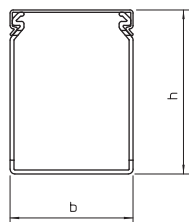

| Type | Colour | Length mm | Dimension | | Pack m | Weight kg/100 m | Item no. |
|-----------|------------|--------------|-------------|--|-----------|--------------------|----------|
| | | | W x H mm | | | | |
| LKV 25025 | Stone grey | 2000 | 25x25 | | 32 | 24.000 | 6178302 |

Wiring trunking to DIN EN 50085-2-3 including cover and base perforation. Special lengths on request.

Wiring trunking, type LKV 37025

PVC

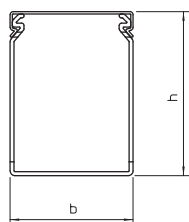

| Type | Colour | Length mm | Dimension | | Pack m | Weight kg/100 m | Item no. |
|-----------|------------|--------------|-------------|--|-----------|--------------------|----------|
| | | | W x H mm | | | | |
| LKV 37025 | Stone grey | 2000 | 25x37,5 | | 32 | 31.500 | 6178305 |

Wiring trunking to DIN EN 50085-2-3 including cover and base perforation. Special lengths on request.

Wiring trunking, type LKV 37037

PVC

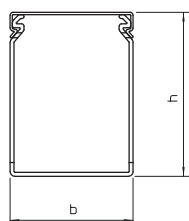
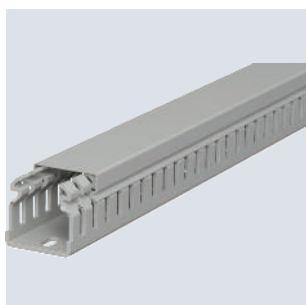

| Type | Colour | Length mm | Dimension | | Pack m | Weight kg/100 m | Item no. |
|-----------|------------|--------------|-------------|--|-----------|--------------------|----------|
| | | | W x H mm | | | | |
| LKV 37037 | Stone grey | 2000 | 37,5x37,5 | | 60 | 40.500 | 6178307 |

Wiring trunking to DIN EN 50085-2-3 including cover and base perforation. Special lengths on request.

Wiring trunking, type LKV 50025

PVC

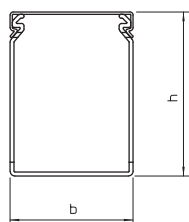
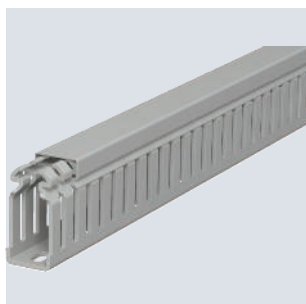

| Type | Colour | Length mm | Dimension | | Pack m | Weight kg/100 m | Item no. |
|-----------|------------|--------------|-------------|--|-----------|--------------------|----------|
| | | | W x H mm | | | | |
| LKV 50025 | Stone grey | 2000 | 25x50 | | 60 | 35.500 | 6178310 |

Wiring trunking to DIN EN 50085-2-3 including cover and base perforation. Special lengths on request.

PVC



| Type | Colour | Dimension | | Pack m | Weight kg/100 m | Item no. |
|-----------|------------|--------------|-------------|-----------|--------------------|----------|
| | | Length mm | W x H mm | | | |
| LKV 50037 | Stone grey | 2000 | 37,5x50 | 48 | 44.500 | 6178312 |

Wiring trunking to DIN EN 50085-2-3 including cover and base perforation. Special lengths on request.

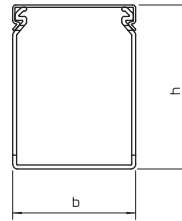

Wiring trunking, type LKV 50050

PVC



| Type | Colour | Dimension | | Pack m | Weight kg/100 m | Item no. |
|-----------|------------|--------------|-------------|-----------|--------------------|----------|
| | | Length mm | W x H mm | | | |
| LKV 50050 | Stone grey | 2000 | 50x50 | 36 | 50.000 | 6178314 |

Wiring trunking to DIN EN 50085-2-3 including cover and base perforation. Special lengths on request.

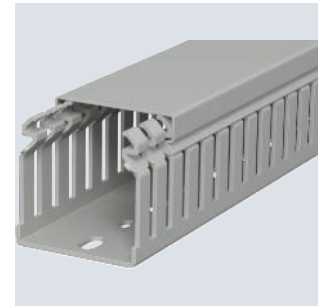
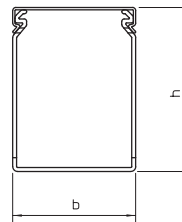

Wiring trunking, type LKV 50075

PVC



| Type | Colour | Dimension | | Pack m | Weight kg/100 m | Item no. |
|-----------|------------|--------------|-------------|-----------|--------------------|----------|
| | | Length mm | W x H mm | | | |
| LKV 50075 | Stone grey | 2000 | 75x50 | 24 | 66.000 | 6178316 |

Wiring trunking to DIN EN 50085-2-3 including cover and base perforation. Special lengths on request.

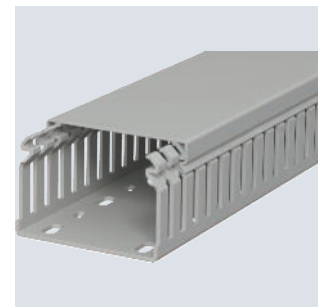
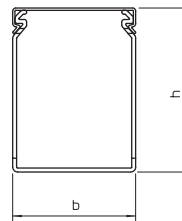

Wiring trunking, type LKV 75025

PVC



| Type | Colour | Dimension | | Pack m | Weight kg/100 m | Item no. |
|-----------|------------|--------------|-------------|-----------|--------------------|----------|
| | | Length mm | W x H mm | | | |
| LKV 75025 | Stone grey | 2000 | 25x75 | 40 | 48.500 | 6178320 |

Wiring trunking to DIN EN 50085-2-3 including cover and base perforation. Special lengths on request.

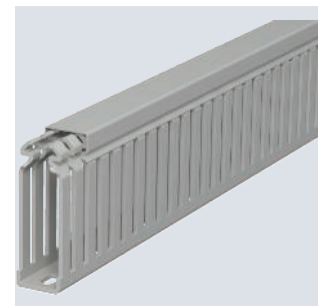
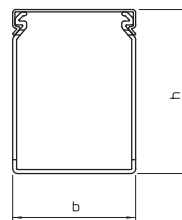

Wiring trunking



Wiring trunking, type LKV 75037

PVC

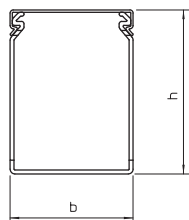

| Type | Colour | Length mm | Dimension | | Pack m | Weight kg/100 m | Item no. |
|-----------|------------|--------------|-------------|--|-----------|--------------------|----------|
| | | | W x H mm | | | | |
| LKV 75037 | Stone grey | 2000 | 37,5x75 | | 32 | 58.500 | 6178322 |

Wiring trunking to DIN EN 50085-2-3 including cover and base perforation. Special lengths on request.

Wiring trunking, type LKV 75050

PVC

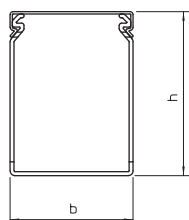
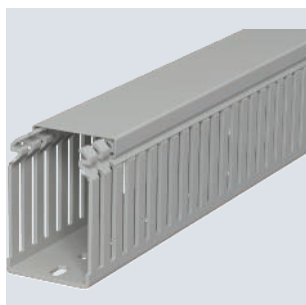

| Type | Colour | Length mm | Dimension | | Pack m | Weight kg/100 m | Item no. |
|-----------|------------|--------------|-------------|--|-----------|--------------------|----------|
| | | | W x H mm | | | | |
| LKV 75050 | Stone grey | 2000 | 50x75 | | 24 | 67.500 | 6178324 |

Wiring trunking to DIN EN 50085-2-3 including cover and base perforation. Special lengths on request.

Wiring trunking, type LKV 75075

PVC

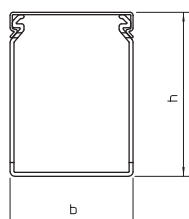
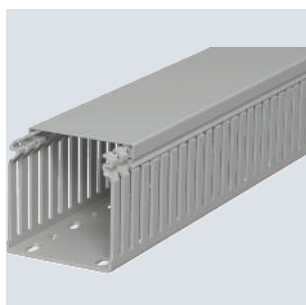

| Type | Colour | Length mm | Dimension | | Pack m | Weight kg/100 m | Item no. |
|-----------|------------|--------------|-------------|--|-----------|--------------------|----------|
| | | | W x H mm | | | | |
| LKV 75075 | Stone grey | 2000 | 75x75 | | 16 | 80.000 | 6178326 |

Wiring trunking to DIN EN 50085-2-3 including cover and base perforation. Special lengths on request.

Wiring trunking, type LKV 75100

PVC

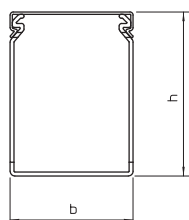
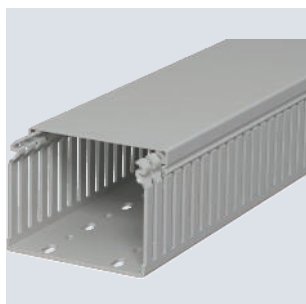

| Type | Colour | Length mm | Dimension | | Pack m | Weight kg/100 m | Item no. |
|-----------|------------|--------------|-------------|--|-----------|--------------------|----------|
| | | | W x H mm | | | | |
| LKV 75100 | Stone grey | 2000 | 100x75 | | 16 | 105.500 | 6178328 |

Wiring trunking to DIN EN 50085-2-3 including cover and base perforation. Special lengths on request.

PVC



| Type | Colour | Dimension | | Pack | Weight | Item no. |
|-----------|------------|-----------|--------|------|---------|----------|
| | | Length | W x H | | | |
| LKV 75125 | Stone grey | 2000 | 125x75 | 8 | 128.500 | 6178330 |

Wiring trunking to DIN EN 50085-2-3 including cover and base perforation. Special lengths on request.

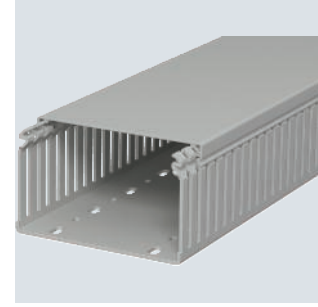
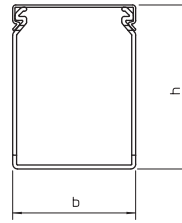

Wiring trunking, type LKV 10037

PVC



| Type | Colour | Dimension | | Pack | Weight | Item no. |
|-----------|------------|-----------|----------|------|--------|----------|
| | | Length | W x H | | | |
| LKV 10037 | Stone grey | 2000 | 37,5x100 | 32 | 67.000 | 6178334 |

Wiring trunking to DIN EN 50085-2-3 including cover and base perforation. Special lengths on request.

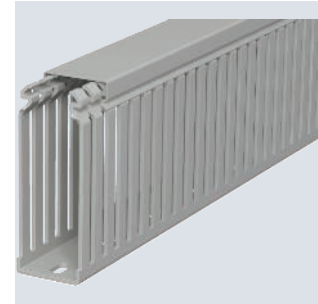
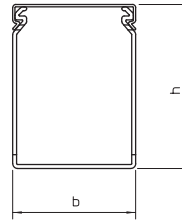

Wiring trunking, type LKV 10050

PVC



| Type | Colour | Dimension | | Pack | Weight | Item no. |
|-----------|------------|-----------|--------|------|--------|----------|
| | | Length | W x H | | | |
| LKV 10050 | Stone grey | 2000 | 50x100 | 24 | 77.000 | 6178336 |

Wiring trunking to DIN EN 50085-2-3 including cover and base perforation. Special lengths on request.

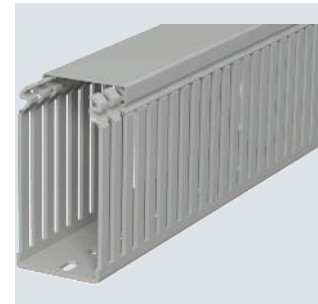
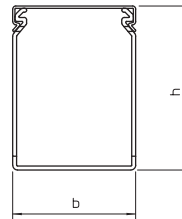

Wiring trunking, type LKV 10075

PVC



| Type | Colour | Dimension | | Pack | Weight | Item no. |
|-----------|------------|-----------|--------|------|--------|----------|
| | | Length | W x H | | | |
| LKV 10075 | Stone grey | 2000 | 75x100 | 16 | 96.000 | 6178338 |

Wiring trunking to DIN EN 50085-2-3 including cover and base perforation. Special lengths on request.

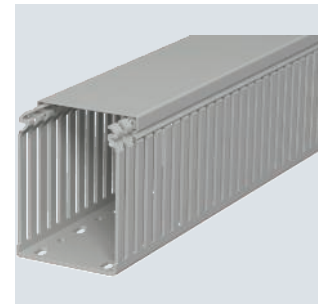
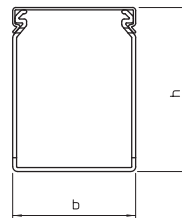

Wiring trunking, type LKV 100100

PVC

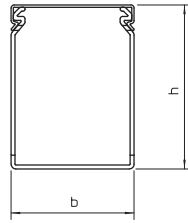
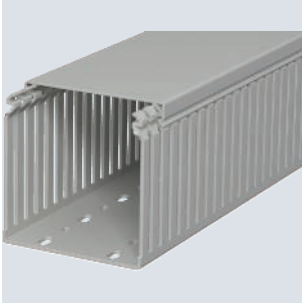

| Type | Colour | Length mm | Dimension | | Pack m | Weight kg/100 m | Item no. |
|------------|------------|--------------|-------------|--|-----------|--------------------|----------|
| | | | W x H mm | | | | |
| LKV 100100 | Stone grey | 2000 | 100x100 | | 8 | 116.500 | 6178341 |

Wiring trunking to DIN EN 50085-2-3 including cover and base perforation. Special lengths on request.

PVC



| Type | Colour | Length mm | Dimension | | Pack m | Weight kg/100 m | Item no. |
|-------------|------------|--------------|-------------|--|-----------|--------------------|----------|
| | | | W x H mm | | | | |
| LKV N 75025 | Stone grey | 2000 | 25x75 | | 40 | 49.500 | 6178420 |

Wiring trunking to DIN EN 50085-2-3 including cover and base perforation, tapering in the side slots stops the cables from falling out.

Wiring trunking, type LKV N 75025

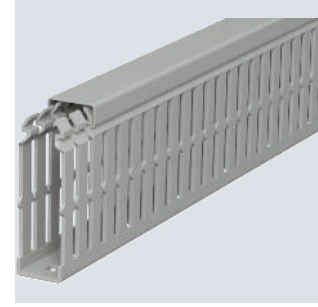
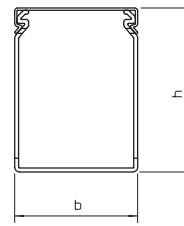

PVC



| Type | Colour | Length mm | Dimension | | Pack m | Weight kg/100 m | Item no. |
|-------------|------------|--------------|-------------|--|-----------|--------------------|----------|
| | | | W x H mm | | | | |
| LKV N 75037 | Stone grey | 2000 | 37,5x75 | | 32 | 60.500 | 6178422 |

Wiring trunking to DIN EN 50085-2-3 including cover and base perforation, tapering in the side slots stops the cables from falling out.

Wiring trunking, type LKV N 75037

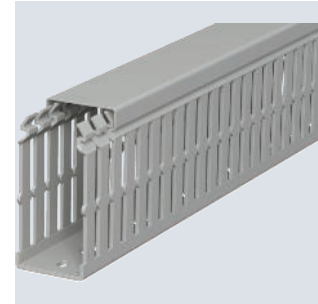
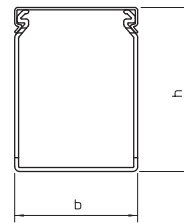

PVC



| Type | Colour | Length mm | Dimension | | Pack m | Weight kg/100 m | Item no. |
|-------------|------------|--------------|-------------|--|-----------|--------------------|----------|
| | | | W x H mm | | | | |
| LKV N 75050 | Stone grey | 2000 | 50x75 | | 24 | 72.500 | 6178424 |

Wiring trunking to DIN EN 50085-2-3 including cover and base perforation, tapering in the side slots stops the cables from falling out.

Wiring trunking, type LKV N 75050

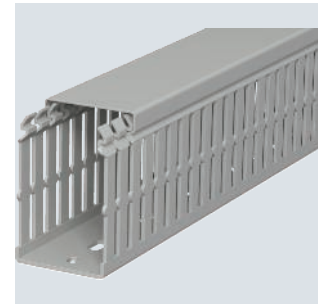
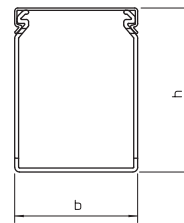

PVC



| Type | Colour | Length mm | Dimension | | Pack m | Weight kg/100 m | Item no. |
|-------------|------------|--------------|-------------|--|-----------|--------------------|----------|
| | | | W x H mm | | | | |
| LKV N 75075 | Stone grey | 2000 | 75x75 | | 16 | 84.500 | 6178426 |

Wiring trunking to DIN EN 50085-2-3 including cover and base perforation, tapering in the side slots stops the cables from falling out.

Wiring trunking, type LKV N 75075

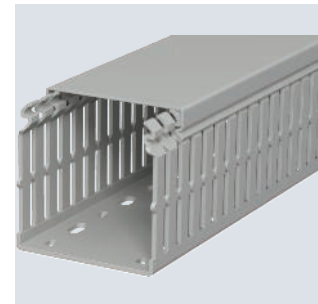
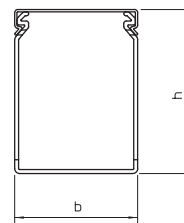

Wiring trunking, type LKV N 75100

PVC

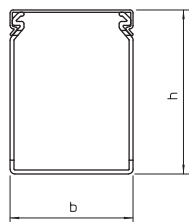
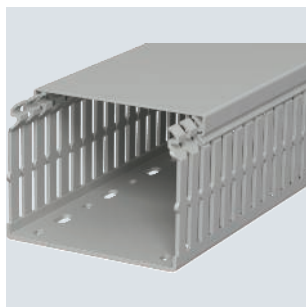

| Type | Colour | Dimension | | Pack m | Weight kg/100 m | Item no. |
|-------------|------------|--------------|-------------|-----------|--------------------|----------|
| | | Length mm | W x H mm | | | |
| LKV N 75100 | Stone grey | 2000 | 100x75 | 16 | 112.000 | 6178428 |

Wiring trunking to DIN EN 50085-2-3 including cover and base perforation, tapering in the side slots stops the cables from falling out.

Wiring trunking, type LKV N 75125

PVC

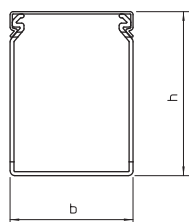
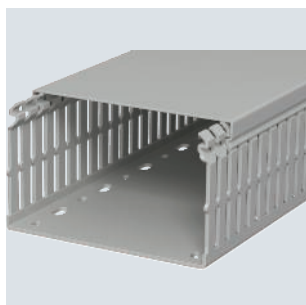

| Type | Colour | Dimension | | Pack m | Weight kg/100 m | Item no. |
|-------------|------------|--------------|-------------|-----------|--------------------|----------|
| | | Length mm | W x H mm | | | |
| LKV N 75125 | Stone grey | 2000 | 125x75 | 8 | 138.500 | 6178430 |

Wiring trunking to DIN EN 50085-2-3 including cover and base perforation, tapering in the side slots stops the cables from falling out.

Wiring trunking, type LKV N 10037

PVC

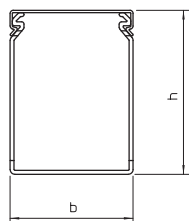
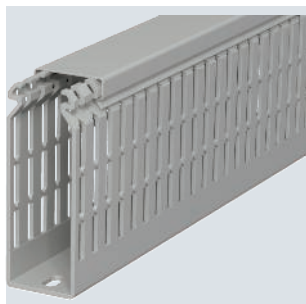

| Type | Colour | Dimension | | Pack m | Weight kg/100 m | Item no. |
|-------------|------------|--------------|-------------|-----------|--------------------|----------|
| | | Length mm | W x H mm | | | |
| LKV N 10037 | Stone grey | 2000 | 37,5x100 | 32 | 73.000 | 6178435 |

Wiring trunking to DIN EN 50085-2-3 including cover and base perforation, tapering in the side slots stops the cables from falling out.

Wiring trunking, type LKV N 10050

PVC

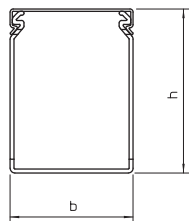
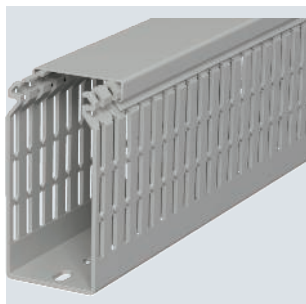

| Type | Colour | Dimension | | Pack m | Weight kg/100 m | Item no. |
|-------------|------------|--------------|-------------|-----------|--------------------|----------|
| | | Length mm | W x H mm | | | |
| LKV N 10050 | Stone grey | 2000 | 50x100 | 24 | 83.000 | 6178437 |

Wiring trunking to DIN EN 50085-2-3 including cover and base perforation, tapering in the side slots stops the cables from falling out.

PVC



Wiring trunking, type LKV N 10075

| Type | Colour | Length mm | Dimension | | Pack m | Weight kg/100 m | Item no. |
|-------------|------------|--------------|-------------|--|-----------|--------------------|----------|
| | | | W x H mm | | | | |
| LKV N 10075 | Stone grey | 2000 | 75x100 | | 16 | 102.000 | 6178439 |

Wiring trunking to DIN EN 50085-2-3 including cover and base perforation, tapering in the side slots stops the cables from falling out.

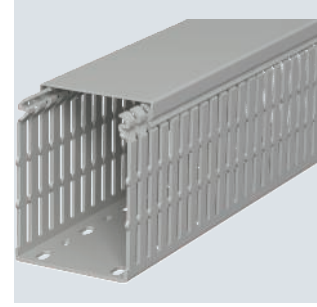
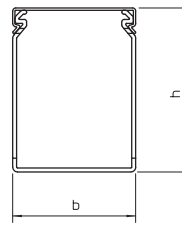

PVC



Wiring trunking, type LKV N 100100

| Type | Colour | Length mm | Dimension | | Pack m | Weight kg/100 m | Item no. |
|--------------|------------|--------------|-------------|--|-----------|--------------------|----------|
| | | | W x H mm | | | | |
| LKV N 100100 | Stone grey | 2000 | 100x100 | | 8 | 122.500 | 6178441 |

Wiring trunking to DIN EN 50085-2-3 including cover and base perforation, tapering in the side slots stops the cables from falling out.

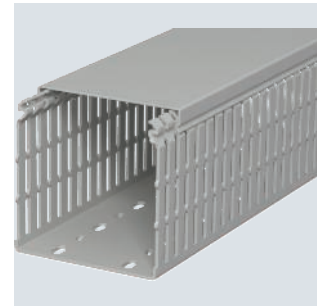
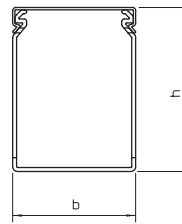

Covers, LKV wiring trunking

PVC



Cover LKV D 25

| Type | Colour | Dim. | | Pack m | Weight kg/100 m | Item no. |
|----------|------------|---------|--------------|-----------|--------------------|----------|
| | | a mm | Length mm | | | |
| LKV D 25 | Stone grey | 25 | 2000 | 36 | 9.500 | 6178504 |

Trunking cover for replacement requirements.

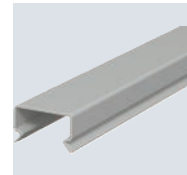
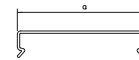

PVC



Cover LKV D 37

| Type | Colour | Dim. | | Pack m | Weight kg/100 m | Item no. |
|----------|------------|---------|--------------|-----------|--------------------|----------|
| | | a mm | Length mm | | | |
| LKV D 37 | Stone grey | 37.5 | 2000 | 24 | 15.000 | 6178506 |

Trunking cover for replacement requirements.

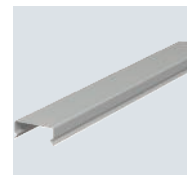
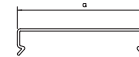

Cover LKV D 50

PVC

CE

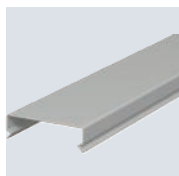

| Type | Colour | Dim. | | Pack | Weight | Item no. |
|----------|------------|------|-----------|------|--------|----------|
| | | a mm | Length mm | | | |
| LKV D 50 | Stone grey | 50 | 2000 | 24 | 17.500 | 6178508 |

Trunking cover for replacement requirements.

Cover LKV D 75

PVC

CE

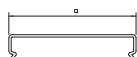
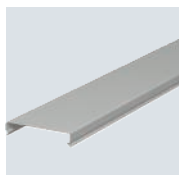

| Type | Colour | Dim. | | Pack | Weight | Item no. |
|----------|------------|------|-----------|------|--------|----------|
| | | a mm | Length mm | | | |
| LKV D 75 | Stone grey | 75 | 2000 | 12 | 23.000 | 6178510 |

Trunking cover for replacement requirements.

Cover LKV D 100

PVC

CE

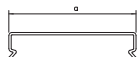
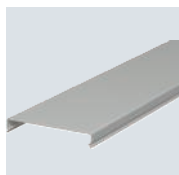

| Type | Colour | Dim. | | Pack | Weight | Item no. |
|-----------|------------|------|-----------|------|--------|----------|
| | | a mm | Length mm | | | |
| LKV D 100 | Stone grey | 100 | 2000 | 12 | 34.500 | 6178512 |

Trunking cover for replacement requirements.

Cover LKV D 125

PVC

CE

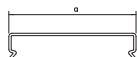
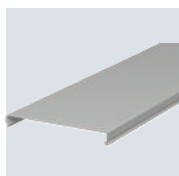

| Type | Colour | Dim. | | Pack | Weight | Item no. |
|-----------|------------|------|-----------|------|--------|----------|
| | | a mm | Length mm | | | |
| LKV D 125 | Stone grey | 125 | 2000 | 16 | 47.000 | 6178514 |

Trunking cover for replacement requirements.



Wiring trunking, type LKV H 50037

PC/
ABS

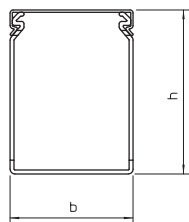
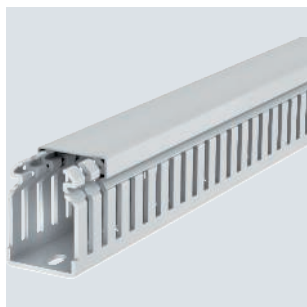

| Type | Colour | Length mm | Dimension W x H mm | | Pack m | Weight kg/100 m | Item no. |
|------------|------------|--------------|--------------------------|----|-----------|--------------------|----------|
| | | | W | H | | | |
| LKVH 50037 | Light grey | 2000 | 37,5 | 50 | 48 | 32.000 | 6178582 |

Wiring trunking, type LKV H 50050

PC/
ABS

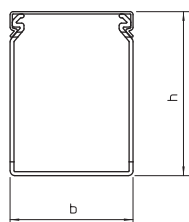
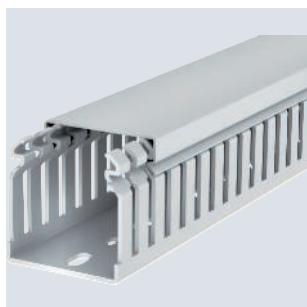

| Type | Colour | Length mm | Dimension W x H mm | | Pack m | Weight kg/100 m | Item no. |
|------------|------------|--------------|--------------------------|----|-----------|--------------------|----------|
| | | | W | H | | | |
| LKVH 50050 | Light grey | 2000 | 50 | 50 | 36 | 37.000 | 6178585 |

Wiring trunking, type LKV H 50075

PC/
ABS

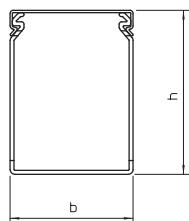

| Type | Colour | Length mm | Dimension W x H mm | | Pack m | Weight kg/100 m | Item no. |
|------------|------------|--------------|--------------------------|----|-----------|--------------------|----------|
| | | | W | H | | | |
| LKVH 50075 | Light grey | 2000 | 75 | 50 | 24 | 52.000 | 6178588 |

Wiring trunking, type LKV H 75037

PC/
ABS

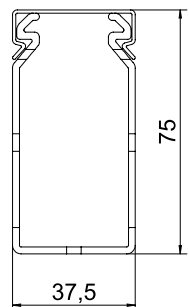
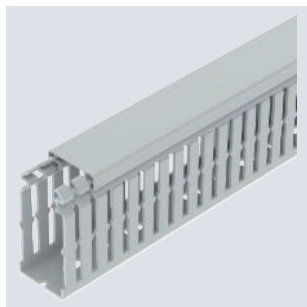

| Type | Colour | Length mm | Dimension W x H mm | | Pack m | Weight kg/100 m | Item no. |
|--------------|------------|--------------|--------------------------|----|-----------|--------------------|----------|
| | | | W | H | | | |
| LKVH N 75037 | Light grey | 2000 | 37,5 | 75 | 32 | 44.000 | 6178552 |

PC/
ABS



Wiring trunking, type LKV H 75050

| Type | Colour | Length mm | Dimension | | Pack m | Weight kg/100 m | Item no. |
|--------------|------------|--------------|-------------|--|-----------|--------------------|----------|
| | | | W x H mm | | | | |
| LKVH N 75050 | Light grey | 2000 | 50x75 | | 24 | 51.000 | 6178556 |

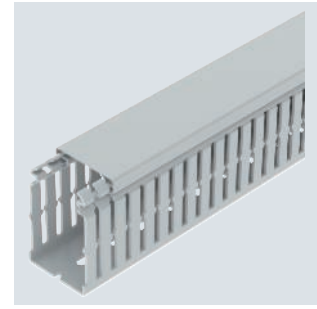
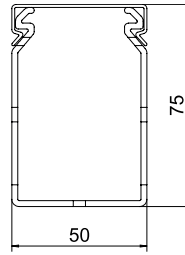

PC/
ABS



Wiring trunking, type LKV H 75075

| Type | Colour | Length mm | Dimension | | Pack m | Weight kg/100 m | Item no. |
|--------------|------------|--------------|-------------|--|-----------|--------------------|----------|
| | | | W x H mm | | | | |
| LKVH N 75075 | Light grey | 2000 | 75x75 | | 16 | 64.000 | 6178559 |

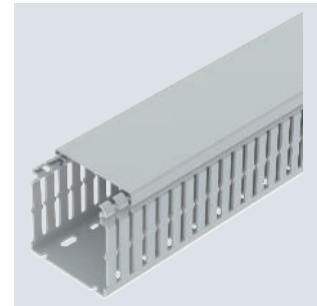
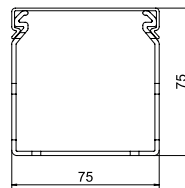

PC/
ABS



Wiring trunking, type LKV H 75100

| Type | Colour | Length mm | Dimension | | Pack m | Weight kg/100 m | Item no. |
|--------------|------------|--------------|-------------|--|-----------|--------------------|----------|
| | | | W x H mm | | | | |
| LKVH N 75100 | Light grey | 2000 | 100x75 | | 16 | 84.000 | 6178563 |

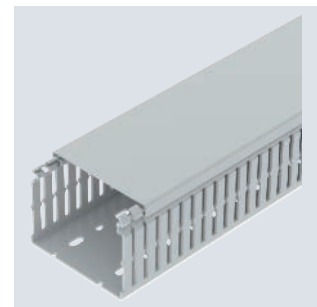
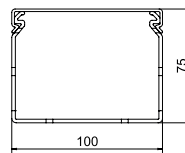

PC/
ABS



Wiring trunking, type LKV H 75125

| Type | Colour | Length mm | Dimension | | Pack m | Weight kg/100 m | Item no. |
|--------------|------------|--------------|-------------|--|-----------|--------------------|----------|
| | | | W x H mm | | | | |
| LKVH N 75125 | Light grey | 2000 | 125x75 | | 8 | 98.500 | 6178566 |

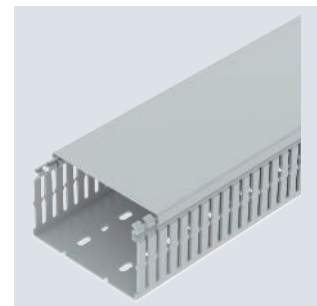
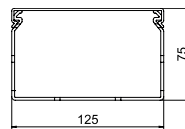

Wiring trunking



Cover LKVH D 37

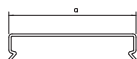

| Type | Colour | Dim. | | Pack | Weight | Item no. |
|-----------|------------|------|--------|------|----------|----------|
| | | a | Length | | | |
| | | mm | mm | m | kg/100 m | |
| LKVH D 37 | Light grey | 37.5 | 2000 | 24 | 8.500 | 6178670 |

Trunking cover for replacement requirements.

Cover LKVH D 50

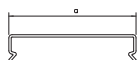
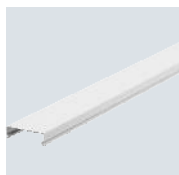

| Type | Colour | Dim. | | Pack | Weight | Item no. |
|-----------|------------|------|--------|------|----------|----------|
| | | a | Length | | | |
| | | mm | mm | m | kg/100 m | |
| LKVH D 50 | Light grey | 50 | 2000 | 24 | 11.000 | 6178674 |

Trunking cover for replacement requirements.

Cover LKVH D 75

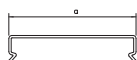

| Type | Colour | Dim. | | Pack | Weight | Item no. |
|-----------|------------|------|--------|------|----------|----------|
| | | a | Length | | | |
| | | mm | mm | m | kg/100 m | |
| LKVH D 75 | Light grey | 75 | 2000 | 12 | 18.000 | 6178678 |

Trunking cover for replacement requirements.

Cover LKVH D 100

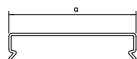
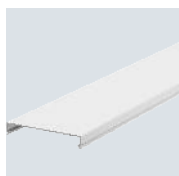

| Type | Colour | Dim. | | Pack | Weight | Item no. |
|------------|------------|------|--------|------|----------|----------|
| | | a | Length | | | |
| | | mm | mm | m | kg/100 m | |
| LKVH D 100 | Light grey | 100 | 2000 | 12 | 27.500 | 6178682 |

Trunking cover for replacement requirements.

Cover LKVH D 125

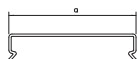
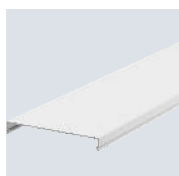

| Type | Colour | Dim. | | Pack | Weight | Item no. |
|------------|------------|------|--------|------|----------|----------|
| | | a | Length | | | |
| | | mm | mm | m | kg/100 m | |
| LKVH D 125 | Light grey | 125 | 2000 | 16 | 34.500 | 6178686 |

Trunking cover for replacement requirements.



Wire retainer for type LK4 and LK4/N

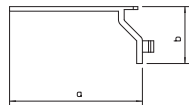
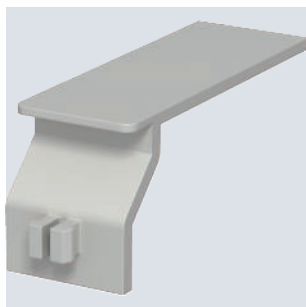

| Type | Colour | Dim. | Dim. | Pack Piece | Weight kg/100 pc. | Item no. |
|-------|------------|------|------|------------|-------------------|----------|
| | | a mm | b mm | | | |
| LK4 H | Stone grey | 56 | 25 | 100 | 0.348 | 6178092 |

Wire retainer for wiring trunking, type LK4 and LK4/N. The wire retainer prevents already inserted cables from falling out. These predetermined breaking points allow the length to be reduced for various trunking widths to 38, 28 and 23 mm.

Wire retainer for type LKV and LKV N

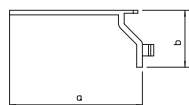
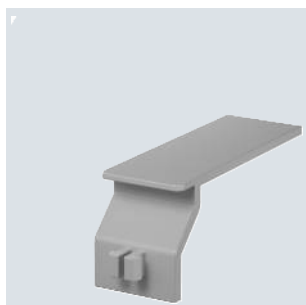

| Type | Colour | Dim. | Dim. | Pack Piece | Weight kg/100 pc. | Item no. |
|-------|------------|------|------|------------|-------------------|----------|
| | | a mm | b mm | | | |
| LKV H | Stone grey | 56 | 25 | 100 | 0.343 | 6178349 |

Wire retainer for wiring trunking, type LKV and LKV/N. The wire retainer prevents already inserted cables from falling out. These predetermined breaking points allow the length to be reduced for various trunking widths to 38, 28 and 23 mm.

Wire retainer for type LKV/H

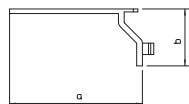

| Type | Colour | Dim. | Dim. | Pack Piece | Weight kg/100 pc. | Item no. |
|---------|------------|------|------|------------|-------------------|----------|
| | | a mm | b mm | | | |
| LKV H H | Light grey | 56 | 25 | 100 | 0.349 | 6178650 |

Wire retainer for halogen-free wiring trunking, type LKV/H. The wire retainer prevents already inserted cables from falling out. These predetermined breaking points allow the length to be reduced for various trunking widths to 38, 28 and 23 mm.

PP



Spreading rivet, KSN 1

| Type | Colour | Pack Piece | Weight kg/100 pc. | Item no. |
|------|------------|------------|-------------------|----------|
| KSN1 | Light grey | 100 | 0.026 | 6178520 |

The KNW1 riveting tool should be used for rapid mounting and for the optimum function.

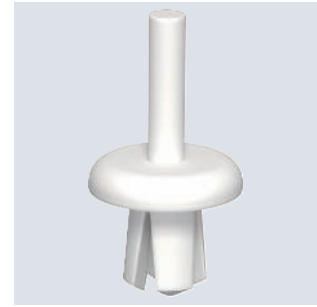
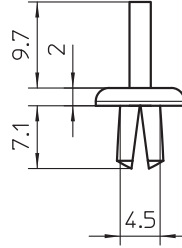

PA



Body-bound rivet, KSN 22

| Type | Colour | Pack Piece | Weight kg/100 pc. | Item no. |
|-------|------------|------------|-------------------|----------|
| KSN22 | Light grey | 100 | 0.070 | 6178525 |

The KNW2 riveting tool should be used for rapid mounting and for the optimum function. Dimension of the drill hole: 6.5 mm.

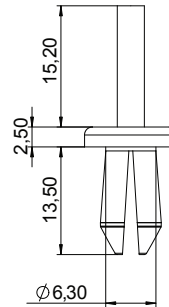

Plastic rivet tools

POM



Plastic rivet tool KNW1

| Type | Colour | Dimension | Pack Piece | Weight kg/100 pc. | Item no. |
|------|--------|-----------|------------|-------------------|----------|
| KNW1 | Black | Ø4,5mm | 1 | 9.300 | 6178527 |

Riveting tool for installing body-bound rivets of 4.5 mm.

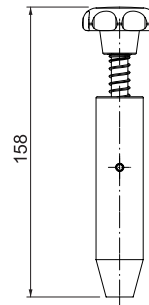

POM



Plastic rivet tool KNW2

| Type | Colour | Dimension | Pack Piece | Weight kg/100 pc. | Item no. |
|------|--------|-----------|------------|-------------------|----------|
| KNW2 | Black | Ø6mm | 1 | 9.400 | 6178529 |

Riveting tool for mounting spreading rivets of 6 mm.

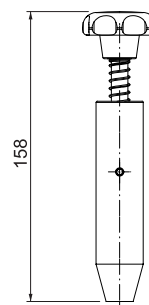

Release pliers

Release pliers

St
CE



| Type | Pack Piece | Weight kg/100 pc. | Item no. |
|------|------------|-------------------|----------|
| AKZ2 | 1 | 45.000 | 6178533 |

To notch the bars down to the trunking base.

Spacer

Spacer

PVC
CE

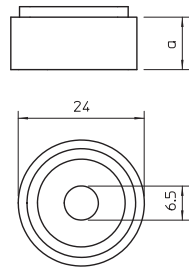
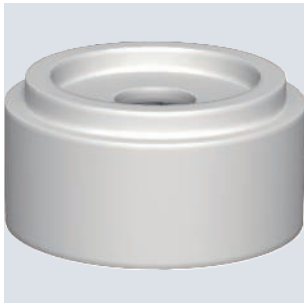

| Type | Colour | Dim. a mm | Pack Piece | Weight kg/100 pc. | Item no. |
|------|--------|-----------|------------|-------------------|----------|
| AH1 | Grey | 12 | 100 | 0.354 | 6178540 |
| AH2 | Grey | 20 | 100 | 0.577 | 6178542 |

Stackable spacer for height compensation between the different component heights.

Identification plates

Identification plate, intrinsically safe circuits

CE



| Type | Colour | Dimension mm | Pack Piece | Weight kg/100 pc. | Item no. |
|--------------|------------|--------------|------------|-------------------|----------|
| VK ISCS 5012 | Light blue | 99x25mm | 20 | 0.100 | 6178643 |

Sticker as an identification plate to attach onto wiring trunking in switchgear cabinets with self-protected power circuits.

St GTP



| Type | Version | Material thickness mm | Length mm | Bundle m | Weight kg/100 m | Item no. |
|-------------|--------------|-----------------------|-----------|----------|-----------------|----------|
| 2069 2M GTP | Unperforated | 1 | 2000 | 50 | 36.040 | 1115650 |

Hat profile rail 35 x 7.5 mm to DIN EN 60715 (formerly DIN EN 50022).

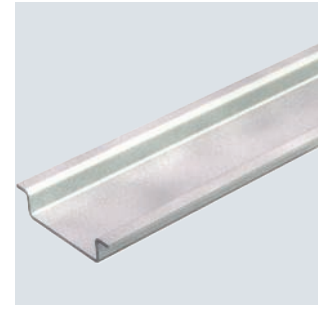
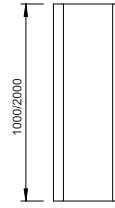
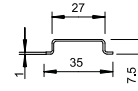

Hat profile rail, unperforated

St GTP



| Type | Version | Material thickness mm | Length mm | Bundle m | Weight kg/100 m | Item no. |
|-------------|------------|-----------------------|-----------|----------|-----------------|----------|
| 2069 2M GTP | Perforated | 1 | 2000 | 50 | 33.280 | 1115669 |

Hat profile rail 35 x 7.5 mm to DIN EN 60715 (formerly DIN EN 50022).

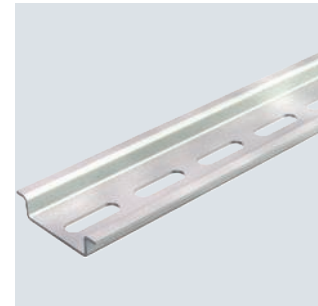
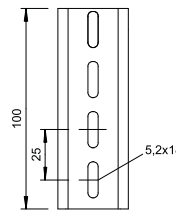
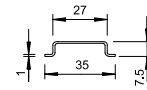

Hat profile rail, perforated

St GTP



| Type | Version | Material thickness mm | Length mm | Bundle m | Weight kg/100 m | Item no. |
|-----------------|------------|-----------------------|-----------|----------|-----------------|----------|
| 2069 15 1.5 GTP | Perforated | 1.5 | 2000 | 20 | 64.000 | 1115456 |

Hat profile rail 35 x 15 mm similar to DIN EN 60715 (formerly DIN EN 50022), but with material thickness 1.5 mm.

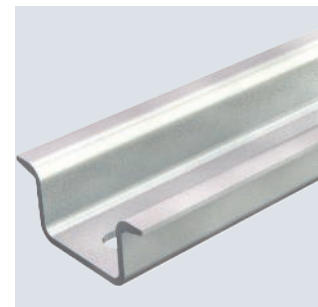
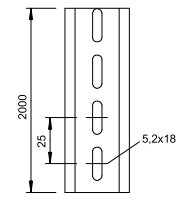
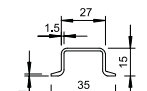

Hat profile rail, perforated

St GTP



| Type | Version | Material thickness mm | Length mm | Bundle m | Weight kg/100 m | Item no. |
|-------------|--------------|-----------------------|-----------|----------|-----------------|----------|
| 2064 GTP 2M | Unperforated | 1.5 | 2000 | 20 | 70.000 | 1115057 |

G rail G32 to DIN EN 60715 (previously DIN EN 50035).

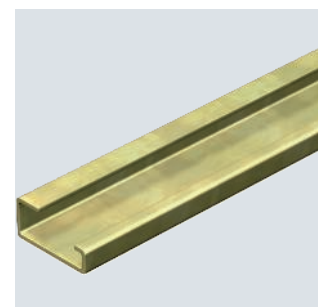
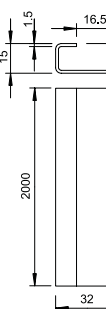
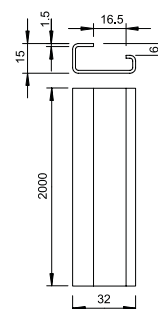

Support rail, unperforated

Support rails

Support rails

Support rail, perforated

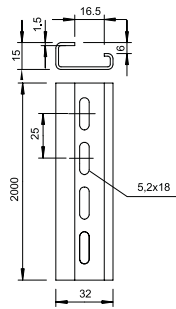

| Type | Version | Material thickness mm | Length mm | Bundle m | Weight kg/100 m | Item no. |
|------|---------|-----------------------|-----------|----------|-----------------|----------------|
| 2064 | GTPL 2M | Perforated | 1,5 | 2000 | 20 | 69.000 1115065 |

G rail G32 to DIN EN 60715 (previously DIN EN 50035).

Washers

Washer

PVC

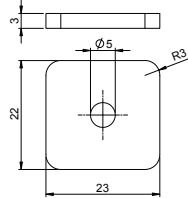

| Type | Colour | Dim. h mm | Pack Piece | Weight kg/100 pc. | Item no. |
|------|--------|-----------|------------|-------------------|----------|
| ULS | Grey | 3 | 100 | 0.170 | 6178548 |

Washer as compensation for different heights.



Wiring trunking VF 10, flexible

PP

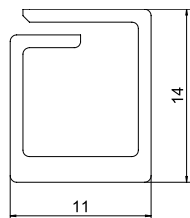
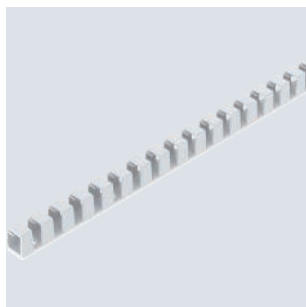

| Type | Colour | Length mm | Width mm | Height mm | Pack Piece | Weight kg/100 pc. | Item no. |
|-------------|------------|--------------|-------------|--------------|---------------|----------------------|----------|
| VF 10 rws | Pure white | 500 | 11 | 14 | 1 | 1.300 | 6132600 |
| VF 10KB rws | Pure white | 500 | 11 | 14 | 1 | 1.350 | 6132601 |

Flexible wiring trunking for horizontal and vertical routing in the switchgear cabinet.

Wiring trunking VF 20, flexible

PP

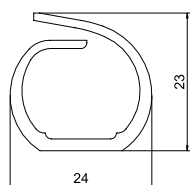

| Type | Colour | Length mm | Width mm | Height mm | Pack Piece | Weight kg/100 pc. | Item no. |
|-------------|------------|--------------|-------------|--------------|---------------|----------------------|----------|
| VF 20 rws | Pure white | 500 | 24 | 24 | 1 | 2.800 | 6132603 |
| VF 20KB rws | Pure white | 500 | 24 | 24 | 1 | 2.950 | 6132604 |

Flexible wiring duct for horizontal and vertical routing in the switchgear cabinet.

Wiring trunking VF 30, flexible

PP

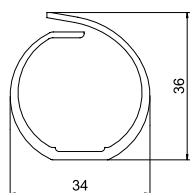

| Type | Colour | Length mm | Width mm | Height mm | Pack Piece | Weight kg/100 pc. | Item no. |
|-------------|------------|--------------|-------------|--------------|---------------|----------------------|----------|
| VF 30 rws | Pure white | 500 | 34 | 36 | 1 | 4.700 | 6132606 |
| VF 30KB rws | Pure white | 500 | 34 | 36 | 1 | 5.000 | 6132607 |

Flexible wiring trunking for horizontal and vertical routing in the switchgear cabinet.

Wiring trunking VF 40, flexible

PP

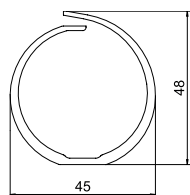





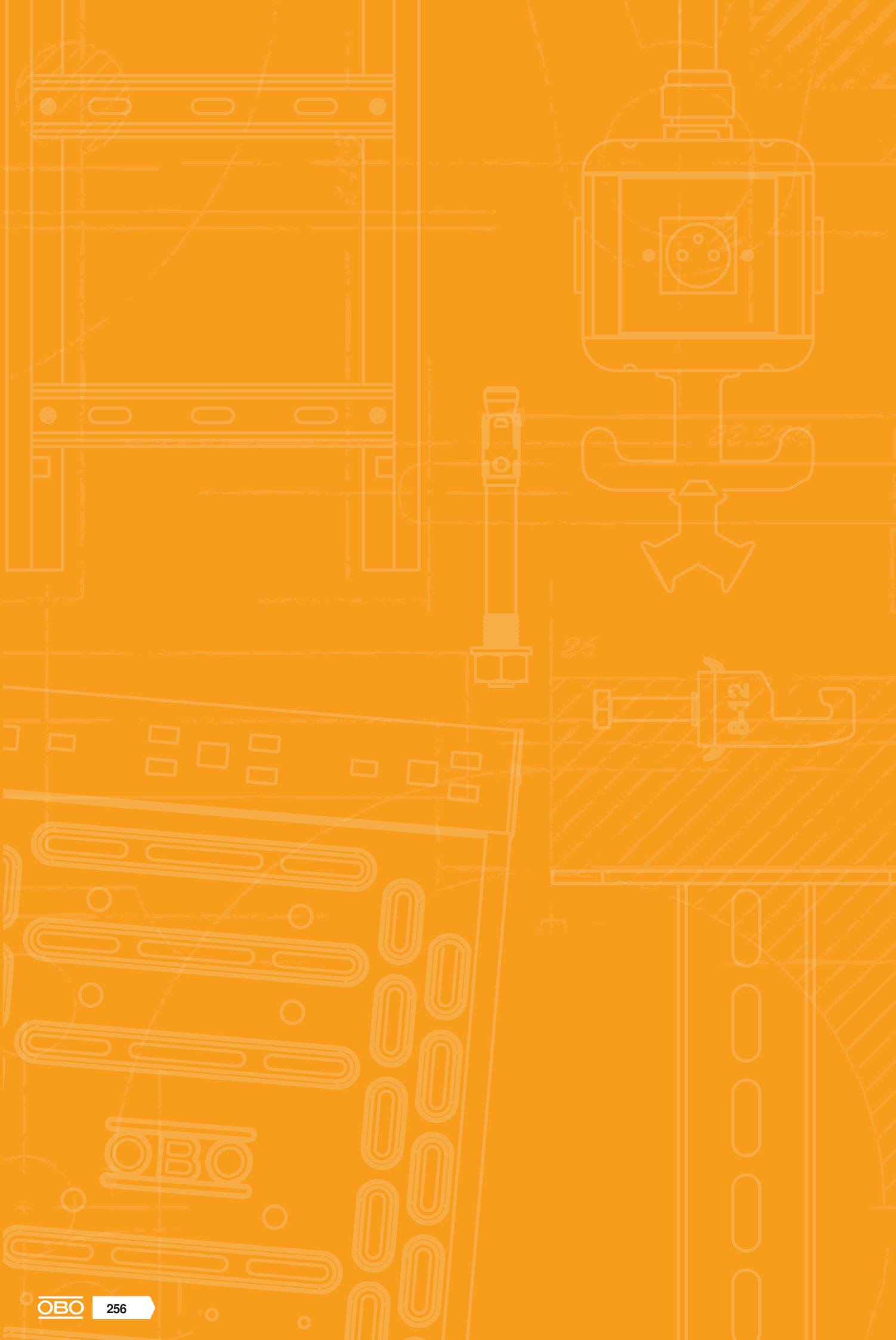

| Type | Colour | Length mm | Width mm | Height mm | Pack Piece | Weight kg/100 pc. | Item no. |
|-------------|------------|--------------|-------------|--------------|---------------|----------------------|----------|
| VF 40 rws | Pure white | 500 | 45 | 48 | 1 | 7.600 | 6132609 |
| VF 40KB rws | Pure white | 500 | 45 | 48 | 1 | 8.000 | 6132610 |

Flexible wiring trunking for horizontal and vertical routing in the switchgear cabinet.



























Directories

| | | |
|---|--|-----|
|  | Test marks | 258 |
|  | Pictogram explanation | 260 |
|  | Alphabetical table of contents | 264 |
|  | Numeric directory | 270 |
|  | Type listing | 274 |
|  | For the latest general conditions of sale and delivery please see www.obo.global/general-purchasing-conditions/ | |

























Test marks

| | | | |
|---|--|---|--|
|  | American Bureau of Shipping, USA |  | Underwriters Laboratories Inc., USA + CSA, Canada |
|  | AENOR, Producto Certificado, Spain |  | Österreichischer Verband für Elektrotechnik, Austria |
|  | STOWARZYSZENIE ELEKTRYKÓW POLSKICH, Poland |  | ISTITUTO ITALIANO DEL MARCHO DI QUALITÀ, Italy |
|  | Lightning current-tested |  | RINA 1861, Ship Classification, Certification and Services |
|  | Lightning current-tested, Class H (100 kA) |  | Underwriters Laboratories Inc., USA |
|  | CEBEC, Belgium |  | SEMKO An Inchcape Testing Services Company, Sweden |
|  | Canadian Standards Association, Canada |  | Eidgenössisches Starkstrominspektorat, Switzerland |
|  | DEMKO, Danmarks Elektriske Materielkontrol, Denmark |  | South African Bureau of Standards |
|  | Deutsches Institut für Bautechnik Berlin, Germany |  | Shock-tested, Bundesamt für Zivilschutz, Germany |
|  | Det Norske Veritas |  | Sähkötarkastuskeskus Elinspektionscentralen Electrical Inspectorate, Finland |
|  | ENEC Austria |  | Underwriters Laboratories Inc., USA |
|  | ATEX certificate for explosive areas |  | Underwriters Laboratories Inc., USA |
|  | ELEKTROTECHNICKÝ ZKUŠEBNÍ ÚSTAV, Czech Republic |  | Verband der Elektrotechnik, Elektronik, Informationstechnik e.V., Germany |
|  | FIMKO, Finland |  | German Association of Electricians, tested safety |
|  | Forschungs- und Materialprüfungsanstalt, Germany |  | 5-year warranty |
|  | Russia, GOST The State Committee for Standards | | |
|  | Test marks for technical resources, VDE Prüf- und Zertifizierungsinstitut Offenbach, Germany | | |
|  | Halogen-free; without chlorine, fluorine and bromine | | |
|  | INMETRO, Brazil | | |
|  | KEMA-KEUR, Netherlands | | |
|  | Indication of metric products | | |
|  | MAGYAR ELEKTROTECHNIKAI ELLENŐRZŐ INTÉZET Budapest, Hungary | | |
|  | NEMKO, Norway | | |
|  | AFNOR Quality symbol of the French standardisation institute | | |





Pictogram explanation





Surfaces

| | |
|---|---|
|  FS | Strip galvanised |
|  FSK | Strip galvanised/plastic-coated |
|  DD | Strip galvanised zinc/aluminium, double dip |
|  BK | Bright |
|  2B | Bright, reworked |
|  EL | Anodised |
|  F | Hot-dip galvanised |
|  G | Electrogalvanised |
|  GK | Electrogalvanised/plastic-coated |
|  GCL | Electrogalvanised, yellow-chromatised |
|  GGP | Electrogalvanised, yellow passivated |
|  GTP | Electrogalvanised, transparently passivated |
|  GR | Primed |
|  L | Painted |
|  SG | Welding primed |
|  FT | Hot-dip galvanised |
|  FT SO | Hot-dip galvanised 85 µm |
|  Cu | Copper-plated |
|  N | Nickel-plated |
|  ZD | Galvanised, Deltatone 500 |
|  ZDM | Galvanised, MAGNI 565 |
|  GA | Zinc-aluminium coated, Galfan |
|  ZL | Zinc scale |





Conformity symbol

| | |
|---|--|
|  | Communautés Européennes, EC declaration of conformity according to EC directives |
|  | RoHS-conformant |



















Quality marks

| | |
|---|--|
|  | Halogen-free; without chlorine, fluorine and bromine |
|  | Flame resistant 650 °C |
|  | Flame resistant 750 °C |
|  | Flame resistant 960 °C |
|  | UV-resistant |



Specific product symbols

| | |
|---|--|
|  | Diameter 60 mm |
|  | Diameter 68 mm |
|  | Protection device to DIN EN 61643-11 or IEC 61643-11 |
|  | Transition from LPZ 2 to LPZ 3 |
|  | Acoustic signalling |

Applications

| | |
|---|--|
|  | Remote signalling |
|  | Acoustic signalling |
|  | Integrated Service Digital Network, ISDN applications |
|  | Digital Subscriber Line, DSL applications |
|  | Analogue telecommunication |
|  | Category 5 TwisterPair |
|  | Channel Performance to American EIA/TIA standard |
|  | Measuring, controlling and regulating systems |
|  | TV applications |
|  | SAT-TV applications |
|  | MultiBase base |
|  | LifeControl |
|  | Intrinsically safe protection device for potentially explosive areas |
|  | Channel Performance to ISO/IEC 11801 |
|  | Power over Ethernet |
|  | 230/400 V system |
|  | Protection rating IP 54 |
|  | Protection rating IP 65 |

Lightning protection classes

| | |
|---|---|
|  | Protection device to DIN EN 61643-11 or IEC 61643-11 |
|  | Combination protection device made of type 1 and type 2 |
|  | Protection device to DIN EN 61643-11 or IEC 61643-11 |

Lightning protection classes

| | |
|--|--|
| | Protection device to DIN EN 61643-11 or IEC 61643-11 |
| | Protection device to DIN EN 61643-11 or IEC 61643-11 |

Lightning protection zone

| | |
|--|--------------------------------|
| | Transition from LPZ 0 to LPZ 1 |
| | Transition from LPZ 0 to LPZ 2 |
| | Transition from LPZ 0 to LPZ 3 |
| | Transition from LPZ 1 to LPZ 2 |
| | Transition from LPZ 1 to LPZ 3 |
| | Transition from LPZ 2 to LPZ 3 |

BSS maintenance of electrical function installation

| | |
|--|--|
| | Fire-tested systems |
| | Escape route ceiling mounting with pressure clip |
| | OBO Grip, wall routing type |
| | OBO Grip, ceiling routing type |
| | Pressure clip for maintenance of electrical function, ceiling mounting |

BSS anchor

| | |
|--|--------------------------|
| | Fire protection anchor |
| | Fire protection bolt tie |

BSS test marks/material class

| | |
|--|--|
| | Maintenance of electrical function class E30 |
| | Maintenance of electrical function class E90 |

Clamp clip base shapes

| | |
|--|--|
| | Clamp clip for C profile rail, slot width 11–12 mm |
| | Clamp clip for C profile rail, slot width 16–17 mm |
| | Clamp clip for C profile rail, slot width 18–22 mm |

Diameter

| | |
|--|----------------|
| | Diameter 60 mm |
| | Diameter 68 mm |
| | Diameter 70 mm |
| | Diameter 74 mm |

Entries

| | |
|--|----------------------|
| | 4 cable entries |
| | 6 cable entries |
| | 7 cable entries |
| | 8 cable entries |
| | 9 cable entries |
| | 10 cable entries |
| | 12 cable entries |
| | 10 cable entries ECO |
| | 12 cable entries ECO |
| | 14 cable entries ECO |
| | 16 cable entries |
| | 18 cable entries ECO |
| | 24 cable entries |

Gland thread

| | |
|--|---------------|
| | Thread metric |
| | Thread Pg |

Entry size

| | |
|--|-----------|
| | M20 entry |
| | M25 entry |
| | M32 entry |
| | M40 entry |

KTS side heights









| | |
|--|------------------------------------|
| | Cable tray, side height 35 mm |
| | Cable tray, side height 60 mm |
| | Cable tray, side height 85 mm |
| | Mesh cable tray, side height 35 mm |
| | Mesh cable tray, side height 55 mm |

Materials



| | |
|--|----------------|
| | Flat steel |
| | Angular steel |
| | U steel |
| | Round material |

Pictogram explanation







Nominal cross-section

| | |
|---|---|
|  | Nominal cross-section 1.5 mm ² |
|  | Nominal cross-section 1.5–2.5 mm ² |
|  | Nominal cross-section 2.5 mm ² |
|  | Nominal cross-section 2.5–4 mm ² |
|  | Nominal cross-section 4 mm ² |
|  | Nominal cross-section 4–6 mm ² |
|  | Nominal cross-section 6 mm ² |
|  | Nominal cross-section 10 mm ² |
|  | Nominal cross-section 16 mm ² |













Nominal voltage

| | |
|---|-----------------------|
|  | Nominal voltage 400 V |
|  | Nominal voltage 500 V |
|  | Nominal voltage 660 V |





Polarity

| | |
|---|---------|
|  | 3-pole |
|  | 5-pole |
|  | 7-pole |
|  | 8-pole |
|  | 10-pole |
|  | 12-pole |



Slot widths

| | |
|---|---------------------|
|  | Slot width 7.5 mm |
|  | Slot width 11 mm |
|  | Slot width 11–12 mm |
|  | Slot width 12 mm |
|  | Slot width 15 mm |
|  | Slot width 16 mm |
|  | Slot width 16.5 mm |
|  | Slot width 16–17 mm |
|  | Slot width 17 mm |
|  | Slot width 18 mm |
|  | Slot width 22 mm |
|  | Slot width 35 mm |











Screw heads

| | |
|---|----------------|
|  | Phillips screw |
|  | Torx screw |
|  | Phillips screw |
|  | Pozidriv |











Firing devices

| | |
|---|------------------|
|  | Bolt-firing tool |
|  | Nail device |





Protection rating

| | |
|---|-------------------------|
|  | Protection rating IP 20 |
|  | Protection rating IP 30 |
|  | Protection rating IP 31 |
|  | Protection rating IP 44 |
|  | Protection rating IP 54 |
|  | Protection rating IP 55 |
|  | Protection rating IP 65 |
|  | Protection rating IP 66 |
|  | Protection rating IP 67 |
|  | Protection rating IP 68 |

Metals

| | |
|---|----------------------------|
|  | Aluminium |
|  | Aluminium/steel |
|  | Stainless steel, rustproof |
|  | Stainless steel, rustproof |
|  | Stainless steel, rustproof |
|  | Copper |
|  | Brass |
|  | Steel |
|  | Malleable iron |
|  | Die-cast zinc |

Plastics

| | |
|---|-------------------------------------|
|  | Acrylonitrile butadiene styrene |
|  | Duroplast, Aminoplast, type 131.5 |
|  | Duroplast, melamine resin, type 150 |
|  | Ethylene vinyl acetate |

Plastics

| | |
|--------------------|--------------------------------------|
| FA | Fibre-proof material DIN 28091 |
| GFK | Fibreglass-reinforced plastic |
| NBR SBR | Rubber mixture |
| NBR | Nitrile rubber |
| PETR | Petrolatum |
| PA | Polyamide |
| PA/ GF | Polyamide, fibreglass reinforced |
| PBPT | Polybutylene terephthalate |
| PC | Polycarbonate |
| PE | Polyethylene |
| PP | Polypropylene |
| PP/GF | Polypropylene, fibreglass reinforced |
| PS | Polystyrene |
| PVC | Polyvinylchloride |
| ZELL PE | Cellular polyethylene |



Alphabetical table of contents

A

Antenna socket panel SL BL ANT; 187, 190

B

Blind cover SL BL blind; 187, 190

C

Cable routing trunking MKS 18, trunking width 45; 56

Cable trunking ECK 35, trunking width 35; 118

Cable trunking ECK 50, trunking width 50; 119

CEE adapter flange 16 A; 106

CEE cover plate for installation socket, 16 A; 107

Coupling SL KUP20110; 189

Coupling SL KUP2050; 178

Coupling SL KUP2070; 183

Cover; 36-38, 40-41, 43-44, 46-47, 51-54, 59, 61-65, 67-69, 71, 73, 75, 77-81, 83-87, 89, 91, 93, 95-97, 99-100, 103-104, 107-114, 116-119, 122, 125-126, 128, 130, 132, 134, 136, 138-140, 178, 187, 190, 196, 223-224, 231, 241-242, 246

Cover clip; 112-114, 116, 138-140

Cover for single accessory mounting box, duct width; 108 130 mm

Cover for single accessory mounting box, trunking; 108 width 110 mm

Cover for triple accessory mounting box, duct width; 110 130 mm

Cover for triple accessory mounting box, duct width; 110 150 mm

Cover HFVDK OT100; 231

Cover HFVDK OT25; 231

Cover HFVDK OT40; 231

Cover HFVDK OT60; 231

Cover HFVDK OT80; 231

Cover SL; 178, 187, 190

Cover TRI 3535 OT; 118

Cover TRI 5050 OT; 119

D

Device installation Modul 45; 115

Device support SL 2GT20110; 189

Device support SL 2GT2050; 185

Device support SL ETler20110; 189

Device support SL ETler2050; 185

Device support SL GTler20110; 189

Device support SL GTler2050; 186

Device support SL2GTK5070; 186

Device support, Modul 45; 106

Device tank RD 2GT40105, double; 199

Device tank RD GT40105, double; 198

Device tank RD GT40105, single; 198

Duct clamp, LKM, duct width 100; 166

Duct clamp, LKM, duct width 150 and 200; 167

Duct clamp, LKM, duct width 80; 166

Duct clamp, LKM, for maintenance of electrical function; 167 E30 - E90

Duct, type WDK 15030; 51

Duct, type WDKH -15030; 124

E

Edge protection ring; 147-148, 150, 153, 155, 157, 159, 161, 163, 165

Edge protection ring KSR 30030; 150

Edge protection ring KSR, for duct type LKM 40060; 155

Edge protection ring KSR, for duct type LKM 60150; 161

End piece; 41, 44, 48, 50, 52, 54, 59-60, 62-63, 67, 69, 71, 73, 75, 77, 79, 81, 83, 85, 87, 89, 91, 93, 95, 97-98, 100, 102, 104, 116, 118, 123, 125, 127, 129, 131, 133, 135, 137, 150, 153, 155, 157, 159, 161, 163, 165, 177, 180, 182, 185, 188-189, 197

End piece RD ESL40105; 197

End piece RD ESR40105; 197

End piece SL ESli20110; 188

End piece SL ESli2050; 177

End piece SL ESli2070; 182

End piece SL ESre20110; 189

End piece SL ESre2070; 182

End piece SLT ESli2050; 180

End piece SLT ESli2070; 185

End piece SLT ESre2050; 180

End piece SLT ESre2070; 185

End piece TRI ES350350; 118

End piece, for duct type LKM 30030; 150

End piece, for duct type LKM 40040; 153

End piece, for duct type LKM 40060; 155

End piece, for duct type LKM 60060; 157

End piece, for duct type LKM 60100; 159

End piece, for duct type LKM 60150; 161

End piece, for duct type LKM 60200; 163

End piece, for duct type LKM 80080; 165

End piece, for duct type WDK 100130; 102

End piece, for duct type WDK 10020; 63

End piece, for duct type WDK 100230; 104

End piece, for duct type WDK 10030; 41

End piece, for duct type WDK 15015; 50

End piece, for duct type WDK 15030; 52

End piece, for duct type WDK 15040; 54

End piece, for duct type WDK 20020; 59

End piece, for duct type WDK 20035; 60

End piece, for duct type WDK 20050; 62

End piece, for duct type WDK 25025; 67

End piece, for duct type WDK 25040; 69

End piece, for duct type WDK 30030; 71

End piece, for duct type WDK 30045; 73

End piece, for duct type WDK 40040; 75

End piece, for duct type WDK 40060; 77

End piece, for duct type WDK 40090; 79

End piece, for duct type WDK 40110; 81

End piece, for duct type WDK 60060; 83

End piece, for duct type WDK 60090; 85

End piece, for duct type WDK 60110; 87

End piece, for duct type WDK 60130; 89

End piece, for duct type WDK 60150; 91

End piece, for duct type WDK 60170; 93

End piece, for duct type WDK 60210; 95

End piece, for duct type WDK 60230; 97

End piece, for duct type WDK 80170; 98

End piece, for duct type WDK 80210; 100

End piece, for duct type WDKH 100202; 123

End piece, for duct type WDKH 15030; 125

End piece, for duct type WDKH 20020; 127

End piece, for duct type WDKH 30045; 129

End piece, for duct type WDKH 40060; 131

End piece, for duct type WDKH 60090; 133

End piece, for duct type WDKH 60110; 135

End piece, for duct type WDKH 60150; 137

External corner cover; 53, 63-64, 122, 128, 130

External corner cover, for duct type WDKH 10020; 122

External corner cover, for duct type WDKH 40060; 130

External corner cover, for trunking type WDK 10020; 63-64

External corner cover, for trunking type WDKH 30045; 128



External corner hood; 40, 43, 46-47, 51, 58, 61, 66, 69-70, 72, 74, 76, 78, 80, 82, 84, 86, 88, 90, 92, 94, 96, 124, 126, 132, 134, 136

External corner hood, for duct type WDK 10030; 40

External corner hood, for duct type WDK 15030; 51

External corner hood, for duct type WDK 20020; 58

External corner hood, for duct type WDK 20050; 61

External corner hood, for duct type WDK 25025; 66

External corner hood, for duct type WDK 25040; 69

External corner hood, for duct type WDK 30030; 70

External corner hood, for duct type WDK 30045; 72

External corner hood, for duct type WDK 40040; 74

External corner hood, for duct type WDK 40060; 76

External corner hood, for duct type WDK 40090; 78

External corner hood, for duct type WDK 40110; 80

External corner hood, for duct type WDK 60060; 82

External corner hood, for duct type WDK 60090; 84

External corner hood, for duct type WDK 60110; 86

External corner hood, for duct type WDK 60130; 88

External corner hood, for duct type WDK 60150; 90

External corner hood, for duct type WDK 60170; 92

External corner hood, for duct type WDK 60210; 94

External corner hood, for duct type WDK 60230; 96

External corner hood, for duct type WDKH 15030; 124

External corner hood, for duct type WDKH 20020; 126

External corner hood, for duct type WDKH 60090; 132

External corner hood, for duct type WDKH 60110; 134

External corner hood, for duct type WDKH 60150; 136

External corner RD, AE40105; 196

External corner SL AE20110; 188

External corner SL AE2050; 177

External corner SL AE2070; 182

External corner SLL AE2050; 179

External corner SLL AE2070; 184

External corner, for duct type LKM 40040; 152

External corner, for duct type LKM 40060; 154

External corner, for duct type LKM 60060; 156

External corner, for duct type LKM 60100; 158

External corner, for duct type LKM 60150; 160

External corner, for duct type LKM 60200; 162

External corner, for duct type LKM 80080; 164

External corner, trunking type WDK 100130; 102

External corner, trunking type WDK 80170; 98

F

Flat angle cover; 44, 47, 54, 63-64, 81, 97

Flat angle cover, for duct type WDK 60230; 97

Flat angle cover, for trunking type WDK 10020; 63-64

Flat angle cover, for trunking type WDK 40110; 81

Flat angle hood, for duct type WDK 10030; 40

Flat angle hood, for duct type WDK 15030; 52

Flat angle hood, for duct type WDK 20020; 59

Flat angle hood, for duct type WDK 20050; 62

Flat angle hood, for duct type WDK 25025; 66

Flat angle hood, for duct type WDK 25040; 69

Flat angle hood, for duct type WDK 30030; 70

Flat angle hood, for duct type WDK 30045; 72

Flat angle hood, for duct type WDK 40040; 74

Flat angle hood, for duct type WDK 40060; 76

Flat angle hood, for duct type WDK 40090; 79

Flat angle hood, for duct type WDK 60060; 82

Flat angle hood, for duct type WDK 60090; 85

Flat angle hood, for duct type WDK 60110; 87

Flat angle hood, for duct type WDK 60130; 88

Flat angle hood, for duct type WDK 60150; 90

Flat angle hood, for duct type WDK 60170; 92

Flat angle hood, for duct type WDK 60210; 94

Flat angle hood, for duct type WDKH 15030; 125

Flat angle hood, for duct type WDKH 20020; 126

Flat angle hood, for duct type WDKH 30045; 128

Flat angle hood, for duct type WDKH 40060; 130

Flat angle hood, for duct type WDKH 60090; 132

Flat angle hood, for duct type WDKH 60110; 134

Flat angle hood, for duct type WDKH 60150; 136

Flat angle hood, for trunking type WDKH 10020; 123

Flat angle, for duct type LKM 40040; 153

Flat angle, for duct type LKM 40060; 155

Flat angle, for duct type LKM 60060; 157

Flat angle, for duct type LKM 60100; 159

Flat angle, for duct type LKM 60150; 161

Flat angle, for duct type LKM 60200; 163

Flat angle, for duct type LKM 80080; 165

Flat angle, trunking type WDK 100130; 103

Flat angle, trunking type WDK 80170; 99

Flat angle, trunking type WDK 80210; 100

Floor trunking, type 2650; 200

Front cover; 116

H

Hat profile rail, perforated; 251

Hat profile rail, unperforated; 251

Heating pipe support RD DUO HRT 2 20; 198

I

Identification plate; 250

Insulating foam RD DUO ISO; 198

Internal corner cover; 43, 46, 53, 99-100, 103-104

Internal corner cover, trunking type WDK 100130; 103

Internal corner cover, trunking type WDK 100230; 104

Internal corner cover, trunking type WDK 80170; 99

Internal corner cover, trunking type WDK 80210; 100

Internal corner hood, for duct type WDK 10030; 40

Internal corner hood, for duct type WDK 15030; 51

Internal corner hood, for duct type WDK 20020; 58

Internal corner hood, for duct type WDK 20050; 61

Internal corner hood, for duct type WDK 25025; 66

Internal corner hood, for duct type WDK 25040; 68

Internal corner hood, for duct type WDK 30030; 70

Internal corner hood, for duct type WDK 30045; 72

Internal corner hood, for duct type WDK 40040; 74

Internal corner hood, for duct type WDK 40060; 76

Internal corner hood, for duct type WDK 40090; 78

Internal corner hood, for duct type WDK 40110; 80

Internal corner hood, for duct type WDK 60060; 82

Internal corner hood, for duct type WDK 60090; 84

Internal corner hood, for duct type WDK 60110; 86

Internal corner hood, for duct type WDK 60130; 88

Internal corner hood, for duct type WDK 60150; 90

Internal corner hood, for duct type WDK 60170; 92

Internal corner hood, for duct type WDK 60210; 94

Internal corner hood, for duct type WDK 60230; 96

Internal corner hood, for duct type WDKH 10020; 122

Internal corner hood, for duct type WDKH 15030; 124

Internal corner hood, for duct type WDKH 20020; 126

Internal corner hood, for duct type WDKH 30045; 128

Internal corner hood, for duct type WDKH 40060; 130

Internal corner hood, for duct type WDKH 60090; 132

Internal corner hood, for duct type WDKH 60110; 134

Internal corner hood, for duct type WDKH 60150; 136

Internal corner hood, for trunking type WDK 10020; 63-64

Internal corner RD IE40105; 196

Alphabetical table of contents

Internal corner SL IE20110; 188
Internal corner SL IE2050; 177
Internal corner SL IE2070; 182
Internal corner SLL IE2050; 179
Internal corner SLL IE2070; 184
Internal corner TRI IE350350; 118
Internal corner TRI IE500500; 119
Internal corner, for duct type LKM 40040; 152
Internal corner, for duct type LKM 40060; 154
Internal corner, for duct type LKM 60060; 156
Internal corner, for duct type LKM 60100; 158
Internal corner, for duct type LKM 60150; 160
Internal corner, for duct type LKM 60200; 162
Internal corner, for duct type LKM 80080; 164

J

Joint connector; 147-148, 150, 152, 154, 156, 158, 160, 162, 164
Joint connector LKM SV20; 147
Joint connector, for duct type LKM 800; 164
Joint connector, for duct, type LKM 600; 156
Joint connector, for ducts, type LKM 400; 152, 154
Joint cover; 40, 43, 46, 51, 53, 61, 63-64, 68, 78, 80, 84, 86
Joint cover, for trunking, type WDK 15030; 63-64

K

KM/TWS55 partition; 166
Knock-in anchor; 115
KSR 20020 edge protection ring; 147
KSR edge protection ring, for duct type LKM 40040; 153
KSR edge protection ring, for duct type LKM 60060; 157
KSR edge protection ring, for duct type LKM 60100; 159
KSR edge protection ring, for duct type LKM 60200; 163
KSR edge protection ring, for duct type LKM 80080; 165

L

LKM cable bracket, duct width 100; 167
LKM cable bracket, duct width 150; 167
LKM cable bracket, duct width 200; 168
LKM cable bracket, duct width 60; 167
LKM SV30 joint connector; 148, 150
LKM TWS45 partition; 166

M

Mini duct with adhesive film and hinge cover MD17; 38
Mini duct with adhesive film and hinged cover MD12; 37
Mini trunking with adhesive film and hinge cover MD12; 36-37
Mini trunking with adhesive film and hinge cover MD17; 36, 38
Mini trunking with adhesive film and hinge cover MD4; 36-37
Mini trunking with adhesive film and hinge cover MD7; 36-37
Mounting aid for WDK trunking; 115

P

Partition for trunking height 100 mm; 107
Partition for trunking height 40 mm; 107
Partition for trunking height 60 mm; 107
Partition for trunking height 80 mm; 107
Partition LKM/TWS75; 166
Partition, halogen-free 40; 138
Partition, halogen-free 60; 138
Pipe adapter Trunking on pipe 19 mm; 48
Pipe adapter Trunking on pipe 20 mm; 48
Pipe adapter, trunking to pipe, 16 mm; 48
Plastic rivet tool; 249

R

Release pliers; 250

S

Shears for WDK trunking, mitre cut; 115
Shears for WDK trunking, straight cut; 115
Side closure, device tank SL GTSA2050; 187
Skirting trunking RD 40105; 196
Skirting trunking SL 20110; 188
Skirting trunking SL 2050; 177
Skirting trunking SL 2070; 182
Skirting trunking SLL 2050; 179
Skirting trunking SLL 2070; 184
Skirting trunking SLT 2050; 180
Skirting trunking SLT 2070; 185
SL ESre2050 end piece; 177
Spacer; 250
Spreading rivet, KSN 1; 249
Spreading rivet, KSN 22; 249
Support rail, perforated; 252
Support rail, unperforated; 251

T

T and intersection cover; 75, 77, 79, 81, 83, 85, 87, 89, 91, 93, 95-96, 130, 132, 134, 136
T piece cover; 41, 44, 52, 54, 59, 62, 65, 67, 69, 71, 73, 125-126, 128
T piece hood; 47, 123
T piece, for duct type LKM 40040; 152
T piece, for duct type LKM 40060; 154
T piece, for duct type LKM 60060; 156
T piece, for duct type LKM 60100; 158
T piece, for duct type LKM 60150; 160
T piece, for duct type LKM 60200; 162
T piece, for duct type LKM 80080; 164
T piece, for trunking type WDK 100130; 102-103
T piece, for trunking type WDK 100230; 104
T piece, for trunking type WDK 80170; 98-99
T piece, for trunking type WDK 80210; 100
T-piece hood; 47, 123
Transition piece TRI C 35-16; 118
Transition piece TRI C 35-50; 119
Trunking coupling RD Kup40105; 198
Trunking cover RD OT40105; 196
Trunking cover RDL OT40105; 196
Trunking retaining clip VDK HF KHUni; 232
Trunking, type LKM 20020; 147
Trunking, type LKM 20030; 148
Trunking, type LKM 30030; 150
Trunking, type LKM 40040; 152
Trunking, type LKM 40060; 154
Trunking, type LKM 60060; 156
Trunking, type LKM 60100; 158
Trunking, type LKM 60150; 160
Trunking, type LKM 60200; 162
Trunking, type LKM 80080; 164
Trunking, type WDK 100130; 102
Trunking, type WDK 10020; 62, 64
Trunking, type WDK 100230; 104
Trunking, type WDK 10030; 40
Trunking, type WDK 12022; 42-43
Trunking, type WDK 13025; 46
Trunking, type WDK 15015; 50
Trunking, type WDK 15030; 51, 63-64
Trunking, type WDK 15040; 53



Trunking, type WDK 20020 with adhesive film; 58
 Trunking, type WDK 20020 with base perforation; 58
 Trunking, type WDK 20035; 60
 Trunking, type WDK 20050; 61
 Trunking, type WDK 25025; 66
 Trunking, type WDK 25040; 68
 Trunking, type WDK 30030; 70
 Trunking, type WDK 30045; 72
 Trunking, type WDK 40040; 74
 Trunking, type WDK 40060; 76
 Trunking, type WDK 40090; 78
 Trunking, type WDK 40110; 80
 Trunking, type WDK 60060; 82
 Trunking, type WDK 60090; 84
 Trunking, type WDK 60110; 86
 Trunking, type WDK 60130; 88
 Trunking, type WDK 60150; 90
 Trunking, type WDK 60170; 92
 Trunking, type WDK 60210; 94
 Trunking, type WDK 60230; 96
 Trunking, type WDK 80170; 98
 Trunking, type WDK 80210; 100
 Trunking, type WDK-H 10020; 122
 Trunking, type WDKH 40060; 130
 Trunking, type WDKH-15030; 124
 Trunking, type WDKH-20020; 126
 Trunking, type WDKH-30045; 128
 Trunking, type WDKH-60090; 132
 Trunking, type WDKH-60110; 134
 Trunking, type WDKH-60150; 136
 Trunking, type WDK-N 20050; 61
 Trunking, type WDK-N 25040; 68

W

Washer; 252
 WDK CEE device socket; 106
 WDK CEE intermediate flange 32 A; 106
 WDK cover clip for duct width 110 mm; 113, 139
 WDK cover clip for duct width 130 mm; 114, 139
 WDK cover clip for duct width 150 mm; 114, 140
 WDK cover clip for duct width 170 mm; 114, 140
 WDK cover clip for duct width 210 mm; 114, 140
 WDK cover clip for duct width 230 mm; 114, 140
 WDK cover clip for duct width 90 mm; 113, 139
 WDK cover clip for trunking width 60 mm; 113, 139
 WDK cover for double accessory mounting box, duct; 109
 height 130 mm
 WDK cover for double accessory mounting box, duct; 109
 height 150 mm
 WDK cover for double accessory mounting box, duct; 109
 height 170 mm
 WDK cover for double accessory mounting box, duct; 109
 height 210 mm
 WDK cover for double accessory mounting box,; 108-109
 trunking height 110 mm
 WDK cover for duct width 110 mm; 111
 WDK cover for duct width 130 mm; 111
 WDK cover for duct width 150 mm; 111
 WDK cover for duct width 170 mm; 111
 WDK cover for duct width 210 mm; 112
 WDK cover for duct width 230 mm; 112
 WDK cover for duct width 60 mm; 110
 WDK cover for duct width 90 mm; 111
 WDK cover for single accessory mounting box,; 108, 112
 trunking height 170 mm
 WDK cover for triple accessory mounting box, duct; 110
 height 170 mm

WDK cover for trunking width 40 mm; 110
 WDK device socket, type 2390; 106
 WDKH cover clip, halogen-free 110; 113, 138
 WDKH cover clip, halogen-free 150; 113, 139
 WDKH cover clip, halogen-free 60; 112, 138
 WDKH cover clip, halogen-free 90; 112, 138
 Wire retainer for type LK4 and LK4/N; 248
 Wire retainer for type LKV and LKV/N; 248
 Wire retainer for type LKV/H; 248
 Wiring trunking HF-METRA 100, trunking width 100; 230
 Wiring trunking HF-METRA 100, trunking width 40; 230
 Wiring trunking HF-METRA 100, trunking width 60; 230
 Wiring trunking HF-METRA 100, trunking width 80; 230
 Wiring trunking HF-METRA 30, trunking width 30; 226
 Wiring trunking HF-METRA 40, trunking width 25; 226
 Wiring trunking HF-METRA 40, trunking width 40; 226
 Wiring trunking HF-METRA 40, trunking width 60; 226
 Wiring trunking HF-METRA 60, trunking width 25; 227
 Wiring trunking HF-METRA 60, trunking width 40; 227
 Wiring trunking HF-METRA 60, trunking width 60; 227
 Wiring trunking HF-METRA 60, trunking width 80; 227
 Wiring trunking HF-METRA 80, trunking width 100; 229
 Wiring trunking HF-METRA 80, trunking width 120; 229
 Wiring trunking HF-METRA 80, trunking width 25; 228
 Wiring trunking HF-METRA 80, trunking width 40; 228
 Wiring trunking HF-METRA 80, trunking width 60; 228
 Wiring trunking HF-METRA 80, trunking width 80; 228
 Wiring trunking VF 10, flexible; 254
 Wiring trunking VF 20, flexible; 254
 Wiring trunking VF 30, flexible; 254
 Wiring trunking VF 40, flexible; 254
 Wiring trunking, type 100100; 238, 241
 Wiring trunking, type 10037; 237, 240
 Wiring trunking, type 10050; 237, 240
 Wiring trunking, type 10075; 237, 241
 Wiring trunking, type 25025; 234
 Wiring trunking, type 37025; 234
 Wiring trunking, type 37037; 234
 Wiring trunking, type 50025; 234
 Wiring trunking, type 50037; 235, 244
 Wiring trunking, type 50050; 235, 244
 Wiring trunking, type 50075; 235, 244
 Wiring trunking, type 75025; 235, 239
 Wiring trunking, type 75037; 236, 239, 244
 Wiring trunking, type 75050; 236, 239, 245
 Wiring trunking, type 75075; 236, 239, 245
 Wiring trunking, type 75100; 236, 240, 245
 Wiring trunking, type 75125; 237, 240, 245
 Wiring trunking, type LK4 15015; 214
 Wiring trunking, type LK4 30015; 214
 Wiring trunking, type LK4 30025; 214
 Wiring trunking, type LK4 40025; 214
 Wiring trunking, type LK4 40040; 215
 Wiring trunking, type LK4 40060; 215
 Wiring trunking, type LK4 40080; 215
 Wiring trunking, type LK4 40100; 215
 Wiring trunking, type LK4 60015; 216
 Wiring trunking, type LK4 60025; 216
 Wiring trunking, type LK4 60040; 216
 Wiring trunking, type LK4 60060; 216
 Wiring trunking, type LK4 60080; 217
 Wiring trunking, type LK4 60100; 217
 Wiring trunking, type LK4 60120; 217
 Wiring trunking, type LK4 80025; 217
 Wiring trunking, type LK4 80040; 218

Alphabetical table of contents

Wiring trunking, type LK4 80060; 218
Wiring trunking, type LK4 80080; 218
Wiring trunking, type LK4 80100; 218
Wiring trunking, type LK4 80120; 219
Wiring trunking, type LK4/N 60015; 220
Wiring trunking, type LK4/N 60025; 220
Wiring trunking, type LK4/N 60040; 220
Wiring trunking, type LK4/N 60060; 220
Wiring trunking, type LK4/N 60080; 221
Wiring trunking, type LK4/N 60100; 221
Wiring trunking, type LK4/N 60120; 221
Wiring trunking, type LK4/N 80025; 221
Wiring trunking, type LK4/N 80040; 222
Wiring trunking, type LK4/N 80060; 222
Wiring trunking, type LK4/N 80080; 222
Wiring trunking, type LK4/N 80100; 222
Wiring trunking, type LK4/N 80120; 223





Numeric directory

| GTIN | Item no. | Page | GTIN | Item no. | Page | GTIN | Item no. | Page | GTIN | Item no. | Page | GTIN | Item no. | Page |
|---------|-----------------------------|------|---------|----------------------------|------|---------|---------------------------|------|---------|----------------|------|---------|----------------|------|
| 5044291 | price/100 1115057 | 251 | 6023776 | /100 pc. 6022995 | 113 | 6028993 | price/m 6025447 | 74 | 6723218 | 6131154 | 118 | 6720781 | 6132258 | 187 |
| 5044352 | 1115065 | 252 | | | | 6029051 | 6025617 | 76 | 6723225 | 6131155 | 118 | 6726653 | 6132259 | 188 |
| 5044895 | 1115456 | 251 | | /pc. 6023002 | 85 | 6029112 | 6025633 | 76 | 6723232 | 6131162 | 119 | 6720798 | 6132260 | 179 |
| 5045434 | 1115650 | 251 | 6023837 | 6023002 | 85 | 7005146 | 6025638 | 76 | 6723249 | 6131163 | 119 | 6726660 | 6132261 | 179 |
| 5045496 | 1115669 | 251 | 6023950 | 6023029 | 87 | | | | 6723256 | 6131164 | 119 | 6720804 | 6132262 | 184 |
| | | | 6024070 | 6023045 | 89 | 6029174 | price/m 6025668 | 82 | 6723263 | 6131165 | 119 | 6720811 | 6132263 | 184 |
| | /100 pc. 2351056 | 115 | 6024193 | 6023061 | 93 | | | | 6738519 | 6131171 | 118 | 6720835 | 6132264 | 196 |
| 5669197 | | | | price/m 6023096 | 107 | 6029778 | 6026176 | 98 | 6723270 | 6131172 | 119 | 6726677 | 6132265 | 177 |
| | | | 6024315 | 6023118 | 107 | 6029839 | 6026184 | 98 | 6723294 | 6131179 | 118 | 6726684 | 6132266 | 177 |
| | price/m 6020801 | 200 | 6024377 | 6023118 | 107 | 6029891 | 6026192 | 100 | 6723300 | 6131182 | 118 | 6727599 | 6132267 | 182 |
| 6362530 | 6020887 | 76 | | /pc. 6023126 | 95 | 6029952 | 6026206 | 100 | 6723317 | 6131185 | 119 | 6720842 | 6132269 | 182 |
| 6016273 | 6020895 | 78 | 6024438 | 6023142 | 79 | 6030132 | 6026273 | 102 | 6723317 | 6131185 | 119 | 6720842 | 6132269 | 182 |
| 6016334 | 6020909 | 80 | 6024551 | 6023207 | 106 | 6030194 | 6026281 | 102 | 6738526 | 6131190 | 118 | 6727612 | 6132270 | 182 |
| 6016396 | | | 6024919 | 6023223 | 83 | 6642076 | 6026311 | 104 | 6738533 | 6131191 | 119 | 6727629 | 6132271 | 182 |
| | | | 6025039 | 6023339 | 81 | 6642137 | 6026338 | 104 | 6822287 | 6131377 | 56 | 6720859 | 6132272 | 182 |
| 6016877 | 6021018 | 78 | 6025459 | 6023351 | 113 | 6667451 | 6026354 | 60 | 6822294 | 6131380 | 56 | 6723416 | 6132274 | 188 |
| 7005177 | 6021023 | 78 | 6025572 | 6023352 | 114 | 6642793 | 6026362 | 60 | | | | 6720866 | 6132275 | 188 |
| | price/m 6021034 | 80 | 6026111 | 6023353 | 114 | 6642854 | 6026370 | 60 | 6730810 | 6132150 | 178 | 6719914 | 6132277 | 177 |
| 6016990 | 6021093 | 78 | 6026173 | 6023353 | 114 | 6667512 | 6026400 | 66 | 6748327 | 6132157 | 178 | 6723423 | 6132278 | 177 |
| | /pc. 6021190 | 78 | 6026234 | 6023353 | 114 | 6030255 | 6026419 | 66 | 6748334 | 6132158 | 178 | 6719921 | 6132280 | 196 |
| 6017171 | 6021190 | 78 | 6637874 | 6023353 | 114 | 6030316 | 6026427 | 66 | 6748358 | 6132159 | 178 | 6723447 | 6132281 | 182 |
| 6017652 | 6021336 | 79 | | /pc. 6023517 | 113 | 6030439 | 6026443 | 68 | 6727575 | 6132160 | 196 | 6723454 | 6132282 | 182 |
| 6018253 | 6021492 | 77 | 6026296 | 6023576 | 114 | 6030491 | 6026451 | 68 | 6727582 | 6132161 | 196 | 6723461 | 6132283 | 182 |
| 6018857 | 6021506 | 79 | 6026357 | 6023584 | 114 | 6794591 | 6026468 | 68 | 6723393 | 6132164 | 196 | 6719945 | 6132285 | 197 |
| 6018918 | 6021514 | 81 | 6639250 | | | 7005115 | 6026488 | 68 | 6723409 | 6132165 | 196 | 6724345 | 6132286 | 189 |
| 6018970 | 6021697 | 76 | | /pc. 6024009 | 106 | 6667574 | 6026496 | 70 | 6723508 | 6132166 | 196 | 6724352 | 6132288 | 180 |
| 6019212 | 6021700 | 80 | 6027132 | 6024025 | 106 | 6667758 | 6027016 | 74 | 6724284 | 6132167 | 197 | 6724369 | 6132289 | 180 |
| 6019274 | 6021719 | 76 | 6027255 | 6024033 | 106 | 6667994 | 6027105 | 82 | 6724291 | 6132168 | 197 | 6724376 | 6132291 | 185 |
| 6019335 | 6021727 | 80 | 6027316 | 6024070 | 115 | 6668052 | 6027113 | 84 | 6724307 | 6132169 | 197 | 6724383 | 6132293 | 177 |
| 6019397 | 6021735 | 76 | | /100 pc. 6024070 | 115 | 6668113 | 6027121 | 86 | 6724314 | 6132170 | 198 | 6724390 | 6132294 | 177 |
| 6019458 | 6021743 | 81 | 5787235 | | | 6668236 | 6027156 | 90 | 6724321 | 6132171 | 198 | 6720071 | 6132296 | 182 |
| 6019519 | price/m 6021840 | 86 | 6027439 | 6024106 | 107 | 6668298 | 6027164 | 92 | 6725298 | 6132174 | 198 | 6725366 | 6132297 | 182 |
| | 6021859 | 88 | 6638116 | 6024432 | 90 | 6668359 | 6027172 | 94 | 6725304 | 6132175 | 198 | 6725366 | 6132297 | 182 |
| 6019939 | 6021867 | 92 | 6639496 | 6024468 | 102 | 6668410 | 6027180 | 96 | 6725328 | 6132177 | 198 | 6733446 | 6132304 | 199 |
| 6019991 | 6021883 | 90 | 7250706 | 6024476 | 102 | 6668472 | 6027229 | 98 | 6732869 | 6132178 | 186 | 6726509 | 6132305 | 185 |
| 6637577 | 6021891 | 96 | 7250744 | 6024506 | 102 | 6668533 | 6027237 | 100 | 6732876 | 6132179 | 186 | 6726516 | 6132306 | 185 |
| 6638956 | 6021913 | 84 | 7250768 | | | 6668595 | 6027245 | 102 | 6726615 | 6132190 | 196 | 6730872 | 6132308 | 178 |
| 6020119 | 6021948 | 82 | | /pc. 6024521 | 90 | 6668656 | 6027253 | 104 | 6726639 | 6132193 | 177 | 6793983 | 6132320 | 185 |
| 6020171 | | | 6638291 | 6024548 | 96 | 6668781 | 6027040 | 80 | 6726644 | 6132197 | 187 | 6718863 | 6132544 | 226 |
| | | | 6639670 | 6024581 | 102 | 6667994 | 6027105 | 82 | 6726642 | 6132197 | 187 | 6718863 | 6132544 | 226 |
| 6020232 | 6022006 | 84 | 7250805 | | | 6668052 | 6027113 | 84 | 6726431 | 6132199 | 187 | 6718870 | 6132546 | 226 |
| 6020294 | 6022014 | 86 | | /pc. 6024602 | 97 | 6668113 | 6027121 | 86 | 6726431 | 6132199 | 187 | 6718870 | 6132546 | 226 |
| 6020355 | 6022022 | 88 | 6639854 | 6024611 | 102 | 6668175 | 6027148 | 88 | 6719211 | 6132201 | 177 | 6719044 | 6132548 | 226 |
| 6637515 | 6022030 | 90 | 7250843 | 6024630 | 102 | 6668236 | 6027156 | 90 | 6719235 | 6132205 | 196 | 6719051 | 6132550 | 227 |
| 6020416 | 6022049 | 92 | | /pc. 6024630 | 102 | 6668298 | 6027164 | 92 | 6719269 | 6132207 | 188 | 6719242 | 6132552 | 227 |
| 6638895 | 6022057 | 96 | 6638475 | 6024599 | 90 | 6668359 | 6027172 | 94 | 6719276 | 6132208 | 182 | 6719259 | 6132554 | 227 |
| 6020478 | 6022065 | 94 | 6639854 | 6024602 | 97 | 6668410 | 6027180 | 96 | 6719266 | 6132211 | 179 | 6719266 | 6132556 | 227 |
| | | | 7250867 | 6024611 | 102 | 6668472 | 6027229 | 98 | 6720002 | 6132212 | 179 | 6719273 | 6132560 | 228 |
| 6020539 | 6022073 | 82 | 7250522 | 6024630 | 102 | 6668533 | 6027237 | 100 | 6720019 | 6132214 | 184 | 6719280 | 6132562 | 228 |
| 6020713 | 6022111 | 84 | 7250508 | 6024654 | 98 | 6668595 | 6027245 | 102 | 6720026 | 6132215 | 184 | 6719297 | 6132564 | 228 |
| 6020836 | 6022146 | 86 | | /pc. 6024689 | 98 | 6668656 | 6027253 | 104 | 6720033 | 6132217 | 180 | 6719303 | 6132566 | 228 |
| 6020959 | 6022162 | 88 | 6638659 | 6024769 | 91 | 6642878 | 6027300 | 43 | 6720040 | 6132218 | 180 | 6719310 | 6132568 | 229 |
| 6021079 | 6022189 | 92 | 6640034 | 6024777 | 96 | 6642885 | 6027301 | 43 | 6720059 | 6132221 | 185 | 6734078 | 6132569 | 229 |
| 6021130 | 6022197 | 94 | 6637935 | 6024823 | 91 | 5396703 | 6027318 | 64 | 6720066 | 6132222 | 185 | 6719327 | 6132570 | 230 |
| 6021253 | 6022219 | 84 | 6639311 | 6024831 | 97 | 7005023 | 6027321 | 62 | 6719822 | 6132223 | 186 | 6719334 | 6132572 | 230 |
| 6021376 | 6022235 | 86 | 6028214 | 6024858 | 98 | | price/m 6027325 | 51 | 6719839 | 6132224 | 186 | 6719341 | 6132574 | 230 |
| 6021499 | 6022251 | 88 | 6028276 | 6024874 | 100 | 5164210 | 6027325 | 51 | 6720613 | 6132225 | 178 | 6719358 | 6132576 | 230 |
| 6021611 | 6022286 | 92 | 6028337 | 6024882 | 102 | 5164227 | 6027335 | 53 | 6720620 | 6132226 | 178 | 6719365 | 6132580 | 231 |
| 6021673 | 6022294 | 94 | 6651375 | 6024904 | 104 | 5164265 | 6027360 | 58 | 6719846 | 6132229 | 186 | 6728602 | 6132582 | 231 |
| 6021796 | 6022316 | 85 | | price/m 6024947 | 50 | 5773399 | 6027372 | 66 | 6720644 | 6132230 | 183 | 6719372 | 6132584 | 231 |
| 6021918 | 6022332 | 87 | 6667338 | 6024949 | 50 | 7005207 | 6027374 | 64 | 6719853 | 6132231 | 183 | 6734092 | 6132585 | 231 |
| 6022038 | 6022375 | 92 | 7005054 | | | | price/m 6027504 | 112 | 6719860 | 6132232 | 183 | 6719389 | 6132586 | 231 |
| 6022151 | 6022383 | 82 | 6642250 | 6024955 | 50 | 6639137 | 6027504 | 112 | 6726448 | 6132234 | 187 | 67 | | |



| GTIN | Item no. | Page | GTIN | Item no. | Page | GTIN | Item no. | Page | GTIN | Item no. | Page | GTIN | Item no. | Page |
|---------|---------------------------|------|---------|------------------------|------|---------|------------------------|------|---------|------------------------|------|---------|------------------------|------|
| 5154549 | price/m 6150334 | 38 | 6579495 | /pc. 6158374 | 66 | 6581894 | /pc. 6161200 | 59 | 6111671 | /pc. 6169317 | 108 | 5922865 | /pc. 6176000 | 126 |
| 6507191 | 6150632 | 68 | 6579679 | 6158382 | 69 | 6582075 | 6161219 | 52 | 6111732 | 6169325 | 112 | 5814955 | 6176004 | 128 |
| 6975686 | 6150640 | 68 | 6580033 | 6158404 | 70 | 6582259 | 6161227 | 54 | 6782291 | 6169368 | 109 | 5814962 | 6176008 | 130 |
| 6615766 | 6150702 | 42 | 6580217 | 6158412 | 74 | 6582433 | 6161235 | 66 | 6111855 | 6169376 | 108 | 5814979 | 6176012 | 132 |
| 6623846 | 6150703 | 42 | 6641536 | 6158420 | 72 | 6582617 | 6161243 | 69 | 6111916 | 6169384 | 109 | 5814986 | 6176016 | 134 |
| | price/m | | 6580392 | 6158455 | 59 | 6582976 | 6161278 | 70 | 6782475 | 6169422 | 110 | 5815020 | 6176020 | 136 |
| 6098170 | 6150756 | 62 | 6580576 | 6158463 | 52 | 6641772 | 6161286 | 72 | 6112098 | 6169430 | 109 | 5922919 | 6176036 | 126 |
| 6492251 | 6150764 | 62 | 6580750 | 6158471 | 54 | 6583157 | 6161294 | 74 | 6112159 | 6169449 | 110 | 5815037 | 6176040 | 128 |
| 6508037 | 6150772 | 40 | 6580934 | 6158498 | 67 | 6107711 | 6161308 | 76 | | | | 5815044 | 6176044 | 130 |
| 6491773 | 6150780 | 40 | 6581115 | 6158501 | 69 | 6107773 | 6161316 | 79 | | price/m | | 5815075 | 6176048 | 132 |
| | | | 6581474 | 6158536 | 71 | 6107834 | 6161324 | 81 | 5933779 | 6175375 | 122 | 5815082 | 6176052 | 134 |
| | | | 6581658 | 6158544 | 75 | 6108077 | 6161502 | 82 | 5933984 | 6175377 | 122 | 5815099 | 6176056 | 136 |
| 6098293 | /pc. 6152007 | 64 | 6641895 | 6158552 | 73 | 6108138 | 6161510 | 85 | 5933953 | 6175390 | 124 | 5922971 | 6176072 | 126 |
| 6098354 | 6152015 | 40 | 6581832 | 6158587 | 59 | 6108190 | 6161529 | 87 | 5933991 | 6175392 | 124 | 5815105 | 6176076 | 128 |
| 6507610 | 6152031 | 51 | 6582013 | 6158595 | 52 | 6108251 | 6161537 | 88 | 5812456 | 6175400 | 126 | 5815112 | 6176080 | 130 |
| 6098477 | 6152058 | 53 | 6582198 | 6158609 | 54 | 6108312 | 6161545 | 92 | 5812463 | 6175405 | 128 | 5815129 | 6176084 | 132 |
| 6507375 | 6152082 | 68 | 6582372 | 6158617 | 66 | 6108374 | 6161553 | 94 | 5812470 | 6175410 | 130 | 5815136 | 6176088 | 134 |
| 6507252 | 6152104 | 61 | 6582556 | 6158625 | 69 | 6638536 | 6161561 | 90 | 5812487 | 6175415 | 132 | 5815143 | 6176092 | 136 |
| 6098712 | 6152309 | 65 | 6582914 | 6158641 | 70 | 6639915 | 6161596 | 97 | 5812494 | 6175420 | 134 | | /100 pc. | |
| 6098774 | 6152317 | 41 | 6583096 | 6158668 | 74 | 7251123 | 6161708 | 103 | 5812500 | 6175425 | 136 | 5817864 | 6176122 | 112 |
| 6507795 | 6152384 | 62 | 6641710 | 6158676 | 72 | 7251109 | 6161716 | 103 | 5933977 | 6175457 | 124 | 5817895 | 6176125 | 112 |
| 6099139 | 6152600 | 64 | 6642618 | 6158692 | 50 | 7251147 | 6161759 | 103 | 5817789 | 6175460 | 126 | 5817901 | 6176128 | 113 |
| 6099191 | 6152619 | 40 | 6434473 | 6158706 | 59 | 7251161 | 6161775 | 103 | 5817796 | 6175463 | 128 | 5817918 | 6176131 | 113 |
| 6507733 | 6152686 | 62 | 6434554 | 6158714 | 52 | | /pc. | | 5817802 | 6175466 | 130 | | | |
| | | | 6434596 | 6158722 | 54 | 6580453 | 6161901 | 59 | 5817833 | 6175469 | 132 | | price/m | |
| 6099559 | 6153003 | 64 | 6434657 | 6158730 | 67 | 6580637 | 6161928 | 52 | 5817840 | 6175472 | 134 | 6000050 | 6178001 | 214 |
| 6099610 | 6153011 | 40 | 6434718 | 6158749 | 69 | 6580811 | 6161936 | 54 | 5817857 | 6175475 | 136 | 6000173 | 6178003 | 214 |
| 6507917 | 6153089 | 61 | 6584178 | 6158765 | 71 | 6580996 | 6161944 | 67 | 5812517 | 6175500 | 138 | 6000296 | 6178005 | 214 |
| 6099979 | 6153291 | 64 | 6583270 | 6158773 | 75 | 6581177 | 6161952 | 69 | 5812524 | 6175504 | 138 | 6000418 | 6178010 | 214 |
| 6804498 | 6153305 | 40 | 6643158 | 6158781 | 60 | 6581535 | 6161979 | 71 | | /pc. | | 6000531 | 6178012 | 215 |
| 6507856 | 6153372 | 61 | 6434831 | 6158803 | 73 | 6641956 | 6161987 | 73 | 5933946 | 6175540 | 123 | 6000654 | 6178014 | 215 |
| 6100392 | 6153593 | 63 | 6507559 | 6158838 | 51 | 6581719 | 6161995 | 75 | 5934233 | 6175546 | 125 | 6000777 | 6178016 | 215 |
| 6100453 | 6153607 | 41 | 6507498 | 6158846 | 53 | | | | 5813910 | 6175550 | 127 | 6000890 | 6178018 | 215 |
| 6507672 | 6153674 | 62 | 6507436 | 6158889 | 68 | 6108619 | 6162002 | 77 | 5813927 | 6175554 | 129 | 6001132 | 6178026 | 216 |
| | | | | | | 6108671 | 6162010 | 79 | 5813934 | 6175558 | 131 | 6001255 | 6178028 | 216 |
| 6492138 | 6154026 | 63 | 6103997 | 6159370 | 108 | 6108732 | 6162029 | 81 | 5813941 | 6175562 | 133 | 6001378 | 6178031 | 216 |
| 6491650 | 6154034 | 40 | | | | 6108978 | 6162207 | 83 | 5813958 | 6175566 | 135 | 6001491 | 6178033 | 216 |
| 6615773 | 6154042 | 43 | 6577637 | 6160018 | 58 | 6109036 | 6162215 | 85 | 5813965 | 6175570 | 137 | 6001613 | 6178035 | 217 |
| | | | 6577811 | 6160026 | 51 | 6109098 | 6162223 | 87 | 5933809 | 6175572 | 122 | 6001736 | 6178037 | 217 |
| 6974481 | 6154069 | 61 | 6577996 | 6160034 | 53 | 6109159 | 6162231 | 89 | 5934073 | 6175578 | 124 | 6001859 | 6178039 | 217 |
| 6491957 | 6154115 | 65 | 6578177 | 6160042 | 66 | 6109210 | 6162258 | 93 | 5922780 | 6175581 | 126 | 6002214 | 6178050 | 217 |
| 6491476 | 6154123 | 41 | 6578351 | 6160050 | 68 | 6109272 | 6162266 | 95 | 5814016 | 6175590 | 128 | 6002337 | 6178052 | 218 |
| 6615803 | 6154132 | 44 | 6578719 | 6160077 | 70 | 6638710 | 6162274 | 91 | 5814023 | 6175594 | 130 | 6002450 | 6178054 | 218 |
| | | | 6641413 | 6160085 | 72 | 6640096 | 6162290 | 96 | 5814030 | 6175598 | 132 | 6002573 | 6178056 | 218 |
| 6493272 | 6154166 | 62 | 6584598 | 6160093 | 74 | 6643219 | 6162487 | 60 | 5814047 | 6175602 | 134 | 6002696 | 6178059 | 218 |
| 6491896 | 6154212 | 63 | 6105915 | 6160107 | 76 | 6642670 | 6162495 | 50 | 5814054 | 6175606 | 136 | 6002818 | 6178061 | 219 |
| 6491414 | 6154220 | 40 | 6105977 | 6160115 | 78 | 6583454 | 6162509 | 59 | 5933830 | 6175612 | 122 | | /100 pc. | |
| 6615810 | 6154232 | 44 | 6106035 | 6160123 | 80 | 6583577 | 6162517 | 52 | 5934127 | 6175618 | 124 | 6008339 | 6178092 | 248 |
| | | | 6106271 | 6160301 | 82 | 6583690 | 6162525 | 54 | 5922841 | 6175624 | 126 | | price/m | |
| 6493333 | 6154255 | 62 | 6106332 | 6160328 | 84 | 6583812 | 6162533 | 67 | 5814061 | 6175626 | 128 | 6004850 | 6178201 | 220 |
| 6492077 | 6154328 | 63 | 6106394 | 6160336 | 86 | 6583935 | 6162541 | 69 | 5814078 | 6175630 | 130 | 6004973 | 6178203 | 220 |
| 6491599 | 6154336 | 40 | 6106455 | 6160344 | 88 | 6584239 | 6162576 | 71 | 5814085 | 6175634 | 132 | 6005093 | 6178205 | 220 |
| 6615780 | 6154342 | 43 | 6106516 | 6160352 | 92 | 6641239 | 6162584 | 73 | 5814092 | 6175638 | 134 | 6005215 | 6178207 | 220 |
| | | | 6106578 | 6160360 | 94 | 6583331 | 6162592 | 75 | 5814108 | 6175642 | 136 | 6005307 | 6178209 | 221 |
| 6974542 | 6154360 | 61 | 6638178 | 6160379 | 90 | 6109517 | 6162606 | 77 | 5933885 | 6175648 | 123 | 6005406 | 6178211 | 221 |
| 6492015 | 6154417 | 63 | 6639557 | 6160395 | 96 | 6109579 | 6162614 | 79 | 5934158 | 6175654 | 125 | 6005505 | 6178213 | 221 |
| 6491537 | 6154425 | 40 | 7250546 | 6160485 | 98 | 6109630 | 6162622 | 81 | 5922896 | 6175658 | 126 | 6005802 | 6178225 | 221 |
| 6615797 | 6154432 | 43 | 7250560 | 6160493 | 98 | 6109876 | 6162800 | 83 | 5814115 | 6175662 | 128 | 6005932 | 6178227 | 222 |
| | | | 7250621 | 6160550 | 98 | 6109937 | 6162819 | 85 | 5814122 | 6175666 | 130 | 6006052 | 6178229 | 222 |
| 6493210 | 6154468 | 61 | | /pc. | | 6109999 | 6162827 | 87 | 5814139 | 6175670 | 132 | 6006175 | 6178231 | 222 |
| 6491834 | 6154514 | 63 | 6579013 | 6160603 | 58 | 6110056 | 6162835 | 89 | 5814146 | 6175674 | 134 | 6006298 | 6178233 | 222 |
| 6491353 | 6154522 | 41 | 6579198 | 6160611 | 51 | 6110117 | 6162843 | 93 | 5814153 | 6175678 | 136 | 6006410 | 6178236 | 223 |
| 6615827 | 6154532 | 44 | 6579372 | 6160638 | 53 | 6110179 | 6162851 | 95 | 5933915 | 6175684 | 123 | 6009411 | 6178302 | 234 |
| | | </ | | | | | | | | | | | | |

Numeric directory

| GTIN | Item no. | Page | GTIN | Item no. | Page | GTIN | Item no. | Page | GTIN | Item no. | Page | GTIN | Item no. | Page |
|---------|----------------------------|------|---------|------------------------|------|---------|---------------------------|------|---------|------------------------|------|---------|---------------------------|------|
| 6013319 | price/m 6178422 | 239 | 6676453 | /pc. 6182607 | 84 | 6494590 | price/m 6191029 | 53 | 5959137 | /pc. 6192448 | 47 | 7251581 | 6193410 | 103 |
| 6013432 | 6178424 | 239 | 6676514 | 6182615 | 86 | 6794171 | 6191037 | 58 | 5959113 | 6192449 | 47 | 7251697 | 6193412 | 103 |
| 6013555 | 6178426 | 239 | 6676576 | 6182623 | 88 | 6496938 | 6191045 | 60 | 5959120 | 6192450 | 47 | 7251383 | 6193414 | 99 |
| 6013678 | 6178428 | 240 | 6676637 | 6182631 | 90 | 6505036 | 6191053 | 66 | 5959106 | 6192451 | 47 | 7251482 | 6193415 | 99 |
| 6013791 | 6178430 | 240 | 6676699 | 6182658 | 92 | 6794232 | 6191061 | 68 | 6796212 | 6192459 | 52 | 5959076 | /pc. 6193496 | 46 |
| 6013913 | 6178435 | 240 | 6676750 | 6182666 | 94 | 6794294 | 6191096 | 70 | 6494774 | 6192467 | 54 | 5959069 | 6193498 | 46 |
| 6014033 | 6178437 | 240 | 6676811 | 6182674 | 96 | 6497058 | 6191118 | 72 | 6796274 | 6192475 | 59 | 6223695 | 6193501 | 51 |
| 6014156 | 6178439 | 241 | 7251260 | 6182713 | 103 | 6363490 | 6191126 | 74 | 6504978 | 6192483 | 67 | 6975266 | 6193528 | 53 |
| 6015184 | 6178441 | 241 | 7250928 | 6182748 | 99 | 6794355 | 6191134 | 76 | 6796335 | 6192491 | 69 | 6507313 | 6193560 | 68 |
| 6040209 | 6178480 | 223 | 7250904 | 6182764 | 99 | 6794416 | 6191142 | 78 | 6796397 | 6192513 | 71 | 5461814 | 6193580 | 78 |
| 6040322 | 6178482 | 223 | | /pc. 6182801 | 59 | 6501199 | 6191150 | 80 | 6497232 | 6192521 | 73 | 5462170 | 6193582 | 78 |
| 6040445 | 6178484 | 223 | 6672851 | 6182852 | 67 | 6491292 | 6191207 | 84 | 6796519 | 6192548 | 75 | 5461821 | 6193586 | 80 |
| 6040568 | 6178486 | 223 | 6672912 | 6182887 | 71 | 6363438 | 6191215 | 86 | 6796571 | 6192572 | 81 | 5462187 | 6193588 | 80 |
| 6040681 | 6178488 | 224 | 6672974 | 6182895 | 73 | 6491292 | 6191223 | 88 | 6796571 | 6192596 | 79 | 5461838 | 6193590 | 84 |
| 6040803 | 6178490 | 224 | 6673032 | 6182917 | 75 | 6363377 | 6191231 | 90 | 6500833 | 6192610 | 83 | 5462217 | 6193592 | 84 |
| 6040926 | 6178492 | 224 | 6673094 | 6182925 | 77 | 6491230 | 6191258 | 92 | 6351794 | 6192629 | 85 | 5461845 | 6193598 | 86 |
| 6041282 | 6178504 | 241 | 6673155 | 6182933 | 79 | 6363193 | 6191266 | 94 | 6492435 | 6192740 | 47 | 5462224 | 6193710 | 48 |
| 6041404 | 6178506 | 242 | 6673216 | 6182941 | 81 | 6794478 | 6191304 | 98 | 6712519 | 6192769 | 54 | 5959175 | 6193708 | 48 |
| 6041527 | 6178510 | 242 | 6673278 | | | 6799459 | 6191312 | 100 | 6712571 | 6192777 | 59 | 5959168 | 6193710 | 48 |
| 6041640 | 6178512 | 242 | 6677054 | 6183018 | 83 | 5042273 | 6191347 | 102 | 6492497 | 6192793 | 69 | 5959205 | 6193728 | 48 |
| 6041763 | 6178514 | 242 | 6677115 | 6183026 | 85 | 5042280 | 6191355 | 104 | 6796632 | 6192815 | 70 | 5978053 | 6193729 | 48 |
| 6041886 | /100 pc. 6178520 | 249 | 6677177 | 6183042 | 89 | 5042297 | 6191368 | 110 | 6492558 | 6192823 | 72 | 5959182 | 6193730 | 48 |
| 6337057 | 6178525 | 249 | 6677238 | 6183050 | 91 | 6677297 | 6191378 | 112 | 6492558 | 6192831 | 74 | 5978060 | 6193731 | 48 |
| | /pc. 6178527 | 249 | 6677290 | 6183085 | 93 | 6502752 | 6191383 | 46 | 6796694 | 6192858 | 76 | 7250126 | 6193825 | 99 |
| 6014514 | 6178529 | 249 | 6677351 | 6183121 | 95 | 6976942 | 6191399 | 46 | 6796694 | 6192874 | 81 | 7250140 | 6193827 | 99 |
| 6014637 | 6178533 | 250 | 6677412 | 6183125 | 96 | 6673513 | 6191407 | 46 | 6494835 | 6192896 | 79 | 7250201 | 6193831 | 100 |
| 6688791 | /100 pc. 6178540 | 250 | 6677474 | 6183133 | 72 | 6673575 | 6191415 | 46 | 6796755 | 6192912 | 82 | 7250188 | 6193860 | 100 |
| 6014873 | 6178542 | 252 | 6673391 | 6183141 | 87 | 6673636 | 6191423 | 46 | 6502455 | 6192939 | 87 | 7250225 | 6193864 | 100 |
| 6014996 | 6178548 | 252 | 6673452 | 6183147 | 88 | 6673513 | 6191431 | 46 | 6504916 | 6192959 | 89 | 7250249 | 6193866 | 100 |
| 6015061 | price/m 6178552 | 244 | 6673513 | 6183155 | 79 | 6673698 | 6191439 | 46 | 6796816 | 6192977 | 91 | | /pc. 6194036 | 108 |
| 5803751 | 6178556 | 245 | 6673698 | 6183163 | 81 | 6673759 | 6191447 | 46 | 6796878 | 6192998 | 97 | 6448272 | 6194044 | 108 |
| 5803768 | 6178559 | 245 | 6673810 | 6183171 | 82 | 6677359 | 6191455 | 46 | 6497294 | 6193006 | 104 | 6448098 | 6194052 | 108 |
| 5803799 | 6178563 | 245 | 6673810 | 6183179 | 82 | 6677359 | 6191463 | 46 | 6796939 | 6193024 | 104 | 6447978 | 6194060 | 108 |
| 5803805 | 6178566 | 245 | 6673810 | 6183187 | 82 | 6677719 | 6191471 | 46 | 6796991 | 6193042 | 104 | 6447978 | 6194109 | 108 |
| 5803812 | 6178582 | 244 | 6677832 | 6183195 | 82 | 6677771 | 6191479 | 46 | 6797059 | 6193060 | 104 | 6628636 | 6194117 | 109 |
| 5803744 | 6178585 | 244 | 6677832 | 6183203 | 82 | 6677955 | 6191487 | 46 | 6496990 | 6193078 | 99 | 6628575 | 6194125 | 109 |
| 5803829 | 6178588 | 244 | 6677832 | 6183211 | 82 | 6677955 | 6191495 | 46 | 6496990 | 6193096 | 99 | 6628513 | 6194133 | 109 |
| 5803836 | /pc. 6178643 | 250 | 6677832 | 6183219 | 82 | 6678013 | 6191503 | 46 | 6712694 | 6193114 | 104 | 6628391 | 6194141 | 109 |
| 6149100 | /100 pc. 6178650 | 248 | 6678013 | 6183227 | 82 | 6678075 | 6191511 | 46 | 6492671 | 6193132 | 104 | 6628339 | 6194184 | 109 |
| 5981459 | price/m 6178670 | 246 | 6678136 | 6183235 | 99 | 6678075 | 6191519 | 46 | 6712878 | 6193150 | 104 | 6618910 | 6194192 | 110 |
| 5981466 | 6178674 | 246 | 7250942 | 6183243 | 99 | 6678136 | 6191527 | 46 | 6797110 | 6193168 | 104 | 6618859 | 6194206 | 110 |
| 5981473 | 6178678 | 246 | 7250966 | 6183251 | 99 | 7250942 | 6191535 | 46 | 6492732 | 6193186 | 104 | 6349814 | 6194214 | 110 |
| 5981480 | 6178682 | 246 | 7251024 | 6183259 | 99 | 6362950 | 6191543 | 46 | 7250423 | 6193204 | 104 | 6651672 | price/m 6246966 | 147 |
| 5981497 | 6178686 | 246 | 6673933 | 6183267 | 99 | 6799879 | 6191551 | 46 | 7250386 | 6193222 | 104 | 6118878 | 6246974 | 148 |
| | /pc. 6182011 | 58 | 6673995 | 6183275 | 99 | 6362776 | 6191559 | 46 | 7250447 | 6193240 | 104 | 6746866 | 6246985 | 150 |
| 6674657 | 6182062 | 66 | 6674053 | 6183283 | 99 | 6362479 | 6191567 | 46 | 7250102 | 6193258 | 99 | 6651733 | price/m 6246990 | 152 |
| 6674718 | 6182097 | 70 | 6674114 | 6183291 | 99 | 6800056 | 6191575 | 46 | 7250072 | 6193276 | 99 | | /pc. 6247016 | 154 |
| 6674831 | 6182100 | 72 | 6674176 | 6183300 | 99 | 6362233 | 6191583 | 46 | 7250461 | 6193294 | 104 | 6311897 | 6247091 | 156 |
| 6674893 | 6182119 | 74 | 6674237 | 6183308 | 99 | 6795079 | 6191591 | 46 | 6056033 | 6193312 | 48 | 6312139 | 6247113 | 158 |
| 6674954 | 6182127 | 76 | 6674299 | 6183316 | 99 | 6800896 | 6191600 | 46 | 6056026 | 6193330 | 48 | 6312191 | 6247148 | 160 |
| 6675012 | 6182135 | 78 | 6674473 | 6183324 | 99 | 7251000 | 6191608 | 46 | 6797172 | 6193348 | 50 | 6312252 | 6247164 | 162 |
| 6675074 | 6182143 | 80 | 6674473 | 6183332 | 99 | 7251048 | 6191616 | 46 | 6797233 | 6193366 | 52 | 5691006 | 6247194 | 164 |
| 6675739 | 6182194 | 82 | 6674511 | 6183340 | 99 | 7251062 | 6191624 | 46 | 6975624 | 6193384 | 54 | | /pc. 6247431 | 147 |
| 6675791 | 6182208 | 84 | 6674573 | 6183348 | 99 | 6800896 | 6191632 | 46 | 6056033 | 6193402 | 48 | 6652754 | 6247434 | 148 |
| 6675852 | 6182216 | 86 | 6674635 | 6183356 | 99 | 6674237 | 6191640 | 46 | 6056026 | 6193420 | 48 | 6118991 | 6247458 | 152 |
| 6675913 | 6182224 | 88 | 6674711 | 6183364 | 99 | 6674299 | 6191648 | 46 | 6797233 | 6193438 | 52 | 6315253 | 6247466 | 156 |
| 6675975 | 6182232 | 90 | 6674773 | 6183372 | 99 | 6674350 | 6191656 | 46 | 6975624 | 6193456 | 54 | 6315314 | 6247472 | 164 |
| 6676033 | 6182240 | 92 | 6674411 | 6183380 | 99 | 6674411 | 6191664 | 46 | 6797295 | 6193474 | 56 | 6652018 | 6247490 | 153 |
| 6676095 | 6182259 | 94 | 6674473 | 6183388 | 99 | 6674473 | 6191672 | 46 | 6797295 | 6193492 | 58 | 6312313 | 6247504 | 155 |
| 6676156 | 6182267 | 96 | 6674535 | 6183396 | 99 | 6674535 | 6191680 | 46 | 6797295 | 6193510 | 60 | 6652273 | 6247563 | 152 |
| 7251222 | 6182314 | 103 | 6674597 | 6183404 | 99 | 6674597 | 6191688 | 46 | 6797295 | 6193528 | 62 | 6312733 | 6247571 | 154 |
| 7251208 | 6182349 | 1 | | | | | | | | | | | | |



| GTIN | Item no. | Page | GTIN | Item no. | Page |
|---------|----------------|------|---------|----------------|------|
| | /pc. | | | price/m | |
| 6313037 | 6248071 | 160 | 6644896 | 6249876 | 166 |
| 6313099 | 6248098 | 162 | 5762898 | 6249880 | 166 |
| 6977185 | 6248128 | 156 | | /pc. | |
| 6313396 | 6248144 | 158 | 5685081 | 6249881 | 167 |
| 6313457 | 6248152 | 160 | | /100 pc. | |
| 6313518 | 6248160 | 162 | 5699170 | 6249882 | 166 |
| 6503599 | 6248187 | 156 | 6119233 | 6249884 | 166 |
| 6317837 | 6248209 | 158 | 6119295 | 6249888 | 167 |
| 6317899 | 6248217 | 160 | | /pc. | |
| 6317950 | 6248225 | 162 | 6315376 | 6249906 | 167 |
| 6503353 | 6248284 | 157 | 6315499 | 6249922 | 167 |
| 6575596 | 6248306 | 159 | 6315611 | 6249965 | 167 |
| 6575657 | 6248314 | 161 | 6315673 | 6249981 | 168 |
| 6575718 | 6248322 | 163 | | | |
| 5699026 | 6248328 | 165 | | | |
| 5699033 | 6248332 | 164 | | | |
| 5699040 | 6248336 | 164 | | | |
| 5699057 | 6248340 | 164 | | | |
| 5699064 | 6248344 | 165 | | | |
| 5699095 | 6248428 | 165 | | | |
| 5699101 | 6248432 | 164 | | | |
| 5699118 | 6248436 | 164 | | | |
| 5699125 | 6248450 | 164 | | | |
| 5699156 | 6248454 | 165 | | | |
| | price/m | | | | |
| 6651795 | 6248462 | 147 | | | |
| 6119059 | 6248470 | 148 | | | |
| 6746873 | 6248489 | 150 | | | |
| | price/m | | | | |
| 6651856 | 6248497 | 152 | | | |
| 6313570 | 6248519 | 154 | | | |
| 6977307 | 6248608 | 156 | | | |
| 6313815 | 6248624 | 158 | | | |
| 6313877 | 6248640 | 160 | | | |
| 6313938 | 6248667 | 162 | | | |
| 5691013 | 6248694 | 164 | | | |
| | /pc. | | | | |
| 6652570 | 6248993 | 153 | | | |
| 6313990 | 6249000 | 155 | | | |
| 6652334 | 6249086 | 152 | | | |
| 6314232 | 6249094 | 154 | | | |
| 6652211 | 6249167 | 152 | | | |
| 6314478 | 6249175 | 154 | | | |
| 6652457 | 6249256 | 152 | | | |
| 6318018 | 6249264 | 154 | | | |
| 7269388 | 6249410 | 150 | | | |
| | /pc. | | | | |
| 6652693 | 6249418 | 153 | | | |
| 6575350 | 6249426 | 155 | | | |
| 6503414 | 6249485 | 157 | | | |
| 6314713 | 6249507 | 159 | | | |
| 6314775 | 6249515 | 161 | | | |
| 6314836 | 6249523 | 163 | | | |
| 6503650 | 6249558 | 156 | | | |
| 6314898 | 6249574 | 158 | | | |
| 6314959 | 6249582 | 160 | | | |
| 6315017 | 6249590 | 162 | | | |
| 6977123 | 6249612 | 156 | | | |
| 6315079 | 6249639 | 158 | | | |
| 6315130 | 6249647 | 160 | | | |
| 6315192 | 6249655 | 162 | | | |
| 6503537 | 6249671 | 156 | | | |
| 6318254 | 6249701 | 158 | | | |
| 6318315 | 6249728 | 160 | | | |
| 6318377 | 6249736 | 162 | | | |
| 6503292 | 6249795 | 157 | | | |
| 6575770 | 6249817 | 159 | | | |
| 6575831 | 6249825 | 161 | | | |
| 6575893 | 6249833 | 163 | | | |
| 6018598 | 6249842 | 147 | | | |
| 6018710 | 6249844 | 148 | | | |
| 6018833 | 6249846 | 153 | | | |
| 6863686 | 6249847 | 150 | | | |
| | /pc. | | | | |
| 6018956 | 6249848 | 155 | | | |
| 6019076 | 6249850 | 157 | | | |
| 5020325 | 6249852 | 159 | | | |
| 5020387 | 6249854 | 161 | | | |
| 5020394 | 6249856 | 163 | | | |
| 5691037 | 6249865 | 165 | | | |
| 6678006 | 6249871 | 166 | | | |

Gebäudeinstillation - Leitungsführungssysteme / en / 2023/05/02 10:01:36 (LLExport_03294) / 2023/05/02 10:01:58 10:01:58

Type listing

| Type | GTIN | Item no. | Page | Type | GTIN | Item no. | Page |
|------------------|---------|----------------------|------|--------------|---------|-----------------|------|
| 2064 GTP 2M | 5044291 | price/100 1115057 | 251 | D2-1 130RW | 6448098 | /pc. 6194044 | 108 |
| 2064 GTPL 2M | 5044352 | 1115065 | 252 | D2-1 150RW | 6447978 | 6194052 | 108 |
| 2069 15 1.5 GTPL | 5044895 | 1115456 | 251 | D2-1 170CW | 6111732 | 6169325 | 112 |
| 2069 2M GTP | 5045434 | 1115650 | 251 | D2-1 170RW | 6447497 | 6194060 | 108 |
| 2069 2M GTPL | 5045496 | 1115669 | 251 | D2-2 110CW | 6111855 | 6169376 | 108 |
| | | /100 pc. | | D2-2 110GR | 6103997 | 6159370 | 108 |
| 2370 110 | 6026173 | 6023517 | 113 | D2-2 110RW | 6628636 | 6194109 | 108 |
| 2370 110 | 6026173 | 6023517 | 139 | D2-2 130CW | 6111916 | 6169384 | 109 |
| 2370 130 | 6026234 | 6023525 | 114 | D2-2 130RW | 6628575 | 6194117 | 109 |
| 2370 130 | 6026234 | 6023525 | 139 | D2-2 150CW | 6782291 | 6169368 | 109 |
| 2370 150 | 6637874 | 6023533 | 114 | D2-2 150RW | 6628513 | 6194125 | 109 |
| 2370 150 | 6637874 | 6023533 | 140 | D2-2 170RW | 6628452 | 6194133 | 109 |
| 2370 170 | 6026296 | 6023541 | 114 | D2-2 210RW | 6628391 | 6194141 | 109 |
| 2370 170 | 6026296 | 6023541 | 140 | D2-3 110CW | 6112098 | 6169430 | 109 |
| 2370 210 | 6026357 | 6023576 | 114 | D2-3 110RW | 6628339 | 6194184 | 109 |
| 2370 210 | 6026357 | 6023576 | 140 | D2-3 130CW | 6112159 | 6169449 | 110 |
| 2370 230 | 6639250 | 6023584 | 114 | D2-3 130RW | 6618910 | 6194192 | 110 |
| 2370 230 | 6639250 | 6023584 | 140 | D2-3 150CW | 6782475 | 6169422 | 110 |
| 2370 60 | 6023776 | 6022995 | 113 | D2-3 150RW | 6618859 | 6194206 | 110 |
| 2370 60 | 6023776 | 6022995 | 139 | D2-3 170RW | 6349814 | 6194214 | 110 |
| 2370 90 | 6026111 | 6023509 | 113 | ECK 3535 cws | 6723201 | 6131153 | 118 |
| 2370 90 | 6026111 | 6023509 | 139 | ECK 3535 cws | 6723195 | 6131152 | 118 |
| | | price/m | | ECK 3535 rws | 6723225 | 6131155 | 118 |
| 2371 100 | 6030736 | 6026990 | 107 | ECK 3535 rws | 6723218 | 6131154 | 118 |
| 2371 40 | 6024315 | 6023096 | 107 | ECK 5050 cws | 6723232 | 6131162 | 119 |
| 2371 60 | 6024377 | 6023118 | 107 | ECK 5050 cws | 6723249 | 6131163 | 119 |
| 2371 80 | 6030675 | 6026982 | 107 | ECK 5050 rws | 6723263 | 6131165 | 119 |
| | | /pc. | | ECK 5050 rws | 6723256 | 6131164 | 119 |
| 2390 | 6024919 | 6023207 | 106 | KNW1 | 6014514 | /pc. 6178527 | 249 |
| 2392 | 6027132 | 6024009 | 106 | KNW2 | 6014637 | 6178529 | 249 |
| 2393 16 | 6027255 | 6024025 | 106 | | | /100 pc. | |
| 2393 32 | 6027316 | 6024033 | 106 | KSN1 | 6014279 | 6178520 | 249 |
| 2393 UP | 6027439 | 6024106 | 107 | KSN22 | 6337057 | 6178525 | 249 |
| | | price/m | | | | /pc. | |
| 2410 110CW | 6031030 | 6027644 | 111 | KSR20020 | 6018598 | 6249842 | 147 |
| 2410 110GR | 6023295 | 6022715 | 116 | KSR20030 | 6018710 | 6249844 | 148 |
| 2410 110LGR | 6669257 | 6028152 | 116 | | | /pc. | |
| 2410 110RW | 6976942 | 6191630 | 117 | KSR30030 | 6863686 | 6249847 | 150 |
| 2410 130CW | 6031092 | 6027652 | 111 | | | /pc. | |
| 2410 130GR | 6023356 | 6022723 | 111 | KSR40040 | 6018833 | 6249846 | 153 |
| 2410 130RW | 6502578 | 6191657 | 111 | KSR40060 | 6018956 | 6249848 | 155 |
| 2410 150GR | 6637690 | 6022731 | 111 | | | /pc. | |
| 2410 150RW | 6502516 | 6191673 | 111 | KSR60060 | 6019076 | 6249850 | 157 |
| 2410 170CW | 6031214 | 6027679 | 111 | KSR60100 | 5020325 | 6249852 | 159 |
| 2410 170GR | 6023417 | 6022758 | 116 | KSR60150 | 5020387 | 6249854 | 161 |
| 2410 170LGR | 6773893 | 6028187 | 116 | KSR60200 | 5020394 | 6249856 | 163 |
| 2410 170RW | 6502455 | 6191703 | 116 | | | /pc. | |
| 2410 210CW | 6031276 | 6027687 | 112 | KSR80080 | 5691037 | 6249865 | 165 |
| 2410 210GR | 6023479 | 6022774 | 112 | | | price/m | |
| 2410 210RW | 6502394 | 6191738 | 112 | LK4 15015 | 6000050 | 6178001 | 214 |
| 2410 230CW | 6639137 | 6027504 | 112 | LK4 30015 | 6000173 | 6178003 | 214 |
| 2410 40CW | 6030859 | 6027601 | 110 | LK4 30025 | 6000296 | 6178005 | 214 |
| 2410 40GR | 6023110 | 6022669 | 110 | LK4 40025 | 6000418 | 6178010 | 214 |
| 2410 40RW | 6502936 | 6191568 | 110 | LK4 40040 | 6000531 | 6178012 | 215 |
| 2410 60CW | 6031153 | 6027660 | 110 | LK4 40060 | 6000654 | 6178014 | 215 |
| 2410 60GR | 6023172 | 6022685 | 110 | LK4 40080 | 6000777 | 6178016 | 215 |
| 2410 60LGR | 6669134 | 6028136 | 110 | LK4 40100 | 6000890 | 6178018 | 215 |
| 2410 60RW | 6502752 | 6191592 | 110 | LK4 60015 | 6001132 | 6178026 | 216 |
| 2410 90CW | 6030972 | 6027636 | 111 | LK4 60025 | 6001255 | 6178028 | 216 |
| 2410 90GR | 6023233 | 6022707 | 111 | LK4 60040 | 6001378 | 6178031 | 216 |
| 2650 | 6362530 | 6020801 | 200 | LK4 60060 | 6001491 | 6178033 | 216 |
| | | /100 pc. | | LK4 60080 | 6001613 | 6178035 | 217 |
| 910 SD 6X35 | 5669197 | 2351056 | 115 | LK4 60100 | 6001736 | 6178037 | 217 |
| AH1 | 6014873 | 6178540 | 250 | LK4 60120 | 6001859 | 6178039 | 217 |
| AH2 | 6014996 | 6178542 | 250 | LK4 80025 | 6002214 | 6178050 | 217 |
| AKZ2 | 6688791 | 6178533 | 250 | LK4 80040 | 6002337 | 6178052 | 218 |
| | | /pc. | | LK4 80060 | 6002450 | 6178054 | 218 |
| D2-1 110CW | 6111619 | 6169309 | 108 | LK4 80080 | 6002573 | 6178056 | 218 |
| D2-1 110RW | 6448272 | 6194036 | 108 | LK4 80100 | 6002696 | 6178059 | 218 |
| D2-1 130CW | 6111671 | 6169317 | 108 | LK4 80120 | 6002818 | 6178061 | 219 |
| | | | | LK4 D 100 | 6040803 | 6178490 | 224 |
| | | | | LK4 D 120 | 6040926 | 6178492 | 224 |



Type listing

| Type | GTIN | Item no. | Page | Type | GTIN | Item no. | Page |
|---------------|---------|---------------------|------|--------------|---------|---------------------|------|
| LK4 D 15 | 6040209 | price/m 6178480 | 223 | LKM F60060RW | 6503414 | /pc. 6249485 | 157 |
| LK4 D 25 | 6040322 | 6178482 | 223 | LKM F60100FS | 6312559 | 6248004 | 159 |
| LK4 D 40 | 6040445 | 6178484 | 223 | LKM F60100RW | 6314713 | 6249507 | 159 |
| LK4 D 60 | 6040568 | 6178486 | 223 | LKM F60150FS | 6312610 | 6248012 | 161 |
| LK4 D 80 | 6040681 | 6178488 | 224 | LKM F60150RW | 6314775 | 6249515 | 161 |
| LK4 H | 6008339 | /100 pc. 6178092 | 248 | LKM F60200FS | 6312672 | 6248020 | 163 |
| LK4 N 60015 | 6004850 | price/m 6178201 | 220 | LKM F60200RW | 6314836 | 6249523 | 163 |
| LK4 N 60025 | 6004973 | 6178203 | 220 | LKM F80080FS | 5699026 | 6248328 | 165 |
| LK4 N 60040 | 6005093 | 6178205 | 220 | LKM F80080RW | 5699095 | 6248428 | 165 |
| LK4 N 60060 | 6005215 | 6178207 | 220 | LKM I40040FS | 6652150 | 6247652 | 152 |
| LK4 N 60080 | 6005307 | 6178209 | 221 | LKM I40040RW | 6652211 | 6249167 | 152 |
| LK4 N 60100 | 6005406 | 6178211 | 221 | LKM I40060FS | 6313150 | 6247660 | 154 |
| LK4 N 60120 | 6005505 | 6178213 | 221 | LKM I40060RW | 6314478 | 6249175 | 154 |
| LK4 N 80025 | 6005802 | 6178225 | 221 | LKM I60060FS | 6977185 | 6248128 | 156 |
| LK4 N 80040 | 6005932 | 6178227 | 222 | LKM I60060RW | 6977123 | 6249612 | 156 |
| LK4 N 80060 | 6006052 | 6178229 | 222 | LKM I60100FS | 6313396 | 6248144 | 158 |
| LK4 N 80080 | 6006175 | 6178231 | 222 | LKM I60100RW | 6315079 | 6249639 | 158 |
| LK4 N 80100 | 6006298 | 6178233 | 222 | LKM I60150FS | 6313457 | 6248152 | 160 |
| LK4 N 80120 | 6006410 | 6178236 | 223 | LKM I60150RW | 6315130 | 6249647 | 160 |
| LK4H 30030 | 6718856 | 6132540 | 226 | LKM I60200FS | 6313518 | 6248160 | 162 |
| LK4H 40025 | 6718863 | 6132544 | 226 | LKM I60200RW | 6315192 | 6249655 | 162 |
| LK4H 40040 | 6718870 | 6132546 | 226 | LKM I80080FS | 5699040 | 6248336 | 164 |
| LK4H 40060 | 6719044 | 6132548 | 226 | LKM I80080RW | 5699118 | 6248436 | 164 |
| LK4H D 100 | 6719389 | 6132586 | 231 | LKM K140 | 6119295 | /100 pc. 6249888 | 167 |
| LK4H D 25 | 6719365 | 6132580 | 231 | LKM K65 | 5699170 | 6249882 | 166 |
| LK4H D 40 | 6734092 | 6132585 | 231 | LKM K80 | 6119233 | 6249884 | 166 |
| LK4H D 60 | 6728602 | 6132582 | 231 | LKM KF 60100 | 5685081 | 6249881 | 167 |
| LK4H D 80 | 6719372 | 6132584 | 231 | LKM SV20 | 6652754 | 6247431 | 147 |
| LK4H N 100100 | 6719358 | 6132576 | 230 | LKM SV30 | 6118991 | 6247434 | 148 |
| LK4H N 10040 | 6719327 | 6132570 | 230 | LKM SV30 | 6118991 | 6247434 | 150 |
| LK4H N 10060 | 6719334 | 6132572 | 230 | LKM SV40 | 6315253 | 6247458 | 152 |
| LK4H N 10080 | 6719341 | 6132574 | 230 | LKM SV40 | 6315253 | 6247458 | 154 |
| LK4H N 60025 | 6719051 | 6132550 | 227 | LKM SV60 | 6315314 | 6247466 | 156 |
| LK4H N 60040 | 6719242 | 6132552 | 227 | LKM SV60 | 6315314 | 6247466 | 158 |
| LK4H N 60060 | 6719259 | 6132554 | 227 | LKM SV60 | 6315314 | 6247466 | 160 |
| LK4H N 60080 | 6719266 | 6132556 | 227 | LKM SV80 | 5699019 | 6247472 | 164 |
| LK4H N 80025 | 6719273 | 6132560 | 228 | LKM T40040FS | 6652396 | 6247725 | 152 |
| LK4H N 80040 | 6719280 | 6132562 | 228 | LKM T40040RW | 6652457 | 6249256 | 152 |
| LK4H N 80060 | 6719297 | 6132564 | 228 | LKM T40060FS | 6317592 | 6247733 | 154 |
| LK4H N 80080 | 6719303 | 6132566 | 228 | LKM T40060RW | 6318018 | 6249264 | 154 |
| LK4H N 80100 | 6719310 | 6132568 | 229 | LKM T60060FS | 6503599 | 6248187 | 156 |
| LK4H N 80120 | 6734078 | 6132569 | 229 | LKM T60060RW | 6503537 | 6249671 | 156 |
| LKM A40040FS | 6652273 | /pc. 6247563 | 152 | LKM T60100FS | 6317837 | 6248209 | 158 |
| LKM A40040RW | 6652334 | 6249086 | 152 | LKM T60100RW | 6318254 | 6249701 | 158 |
| LKM A40060FS | 6312733 | 6247571 | 154 | LKM T60150FS | 6317899 | 6248217 | 160 |
| LKM A40060RW | 6314232 | 6249094 | 154 | LKM T60150RW | 6318315 | 6249728 | 160 |
| LKM A60060FS | 6977062 | 6248047 | 156 | LKM T60200FS | 6317950 | 6248225 | 162 |
| LKM A60060RW | 6503650 | 6249558 | 156 | LKM T60200RW | 6318377 | 6249736 | 162 |
| LKM A60100FS | 6312979 | 6248063 | 158 | LKM T80080FS | 5699057 | 6248340 | 164 |
| LKM A60100RW | 6314898 | 6249574 | 158 | LKM T80080RW | 5699125 | 6248450 | 164 |
| LKM A60150FS | 6313037 | 6248071 | 160 | LKM TWS45 | 6678006 | 6249871 | 166 |
| LKM A60150RW | 6314959 | 6249582 | 160 | LKM TWS55 | 6644896 | price/m 6249876 | 166 |
| LKM A60200FS | 6313099 | 6248098 | 162 | LKM TWS75 | 5762898 | 6249880 | 166 |
| LKM A60200RW | 6315017 | 6249590 | 162 | LKM Z100 | 6315499 | /pc. 6249922 | 167 |
| LKM A80080FS | 5699033 | 6248332 | 164 | LKM Z150 | 6315611 | 6249965 | 167 |
| LKM A80080RW | 5699101 | 6248432 | 164 | LKM Z200 | 6315673 | 6249981 | 168 |
| LKM E30030FS | 7269340 | 6247876 | 150 | LKM Z60 | 6315376 | 6249906 | 167 |
| LKM E30030RW | 7269388 | 6249410 | 150 | LKM20020FS | 6651672 | price/m 6246966 | 147 |
| LKM E40040FS | 6652631 | 6247881 | 153 | LKM20020RW | 6651795 | 6248462 | 147 |
| LKM E40040RW | 6652693 | 6249418 | 153 | LKM20030FS | 6118878 | 6246974 | 148 |
| LKM E40060FS | 6575114 | 6247903 | 155 | LKM20030RW | 6119059 | 6248470 | 148 |
| LKM E40060RW | 6575350 | 6249426 | 155 | LKM30030FS | 6746866 | 6246985 | 150 |
| LKM E60060FS | 6503353 | 6248284 | 157 | LKM30030RW | 6746873 | 6248489 | 150 |
| LKM E60060RW | 6503292 | 6249795 | 157 | LKM40040FS | 6651733 | price/m 6246990 | 152 |
| LKM E60100FS | 6575596 | 6248306 | 159 | LKM40040RW | 6651856 | 6248497 | 152 |
| LKM E60100RW | 6575770 | 6249817 | 159 | LKM40060FS | 6311897 | 6247016 | 154 |
| LKM E60150FS | 6575657 | 6248314 | 161 | LKM40060RW | 6313570 | 6248519 | 154 |
| LKM E60150RW | 6575831 | 6249825 | 161 | LKM60060FS | 6977369 | 6247091 | 156 |
| LKM E60200FS | 6575718 | 6248322 | 163 | LKM60060RW | 6977307 | 6248608 | 156 |
| LKM E60200RW | 6575893 | 6249833 | 163 | LKM60100FS | 6312139 | 6247113 | 158 |
| LKM E80080FS | 5699064 | 6248344 | 165 | LKM60100RW | 6313815 | 6248624 | 158 |
| LKM E80080RW | 5699156 | 6248454 | 165 | LKM60150FS | 6312191 | 6247148 | 160 |
| LKM F40040FS | 6652518 | 6247490 | 153 | | | | |
| LKM F40040RW | 6652570 | 6248993 | 153 | | | | |
| LKM F40060FS | 6312313 | 6247504 | 155 | | | | |
| LKM F40060RW | 6313990 | 6249000 | 155 | | | | |
| LKM F60060FS | 6503476 | 6247989 | 157 | | | | |



Type listing

| Type | GTIN | Item no. | Page | Type | GTIN | Item no. | Page |
|------------------|---------|---------------------|------|------------------|---------|-----------------|------|
| LKM60150RW | 6313877 | price/m 6248640 | 160 | RD DUO HRT 2 20 | 6724314 | 6132170 | 198 |
| LKM60200FS | 6312252 | 6247164 | 162 | RD DUO ISO | 6725304 | 6132175 | 198 |
| LKM60200RW | 6313938 | 6248667 | 162 | RD ESL40105 cws | 6724307 | 6132169 | 197 |
| LKM80080FS | 5691006 | 6247194 | 164 | RD ESL40105 rws | 6724291 | 6132168 | 197 |
| LKM80080RW | 5691013 | 6248694 | 164 | RD ESR40105 cws | 6724284 | 6132167 | 197 |
| LKV 100100 | 6011162 | 6178341 | 238 | RD ESR40105 rws | 6719945 | 6132285 | 197 |
| LKV 10037 | 6010806 | 6178334 | 237 | RD GT40105 cws | 6725298 | 6132174 | 198 |
| LKV 10050 | 6010929 | 6178336 | 237 | RD GT40105 rws | 6725281 | 6132173 | 198 |
| LKV 10075 | 6011049 | 6178338 | 237 | RD IE40105 cws | 6723393 | 6132164 | 196 |
| LKV 25025 | 6009411 | 6178302 | 234 | RD IE40105 rws | 6719921 | 6132280 | 196 |
| LKV 37025 | 6009534 | 6178305 | 234 | RD KUP40105 cws | 6725328 | 6132177 | 198 |
| LKV 37037 | 6009657 | 6178307 | 234 | RD KUP40105 rws | 6725311 | 6132176 | 198 |
| LKV 50025 | 6009732 | 6178310 | 234 | RD OT40105 cws | 6727582 | 6132161 | 196 |
| LKV 50037 | 6009831 | 6178312 | 235 | RD OT40105 rws | 6727575 | 6132160 | 196 |
| LKV 50050 | 6009930 | 6178314 | 235 | RDL OT40105 cws | 6726615 | 6132190 | 196 |
| LKV 50075 | 6010073 | 6178316 | 235 | RDL OT40105 rws | 6720835 | 6132264 | 196 |
| LKV 75025 | 6010196 | 6178320 | 235 | | | | |
| LKV 75037 | 6010318 | 6178322 | 236 | | | | |
| LKV 75050 | 6010400 | 6178324 | 236 | | | | |
| LKV 75075 | 6010509 | 6178326 | 236 | | | | |
| LKV 75100 | 6010608 | 6178328 | 236 | | | | |
| LKV 75125 | 6010707 | 6178330 | 237 | | | | |
| LKV D 100 | 6041763 | 6178512 | 242 | RK-E1117GR | 6543137 | /pc. 6156223 | 116 |
| LKV D 125 | 6041886 | 6178514 | 242 | RK-E1117LGR | 6543076 | 6156231 | 116 |
| LKV D 25 | 6041282 | 6178504 | 241 | | | | |
| LKV D 37 | 6041404 | 6178506 | 241 | RK-K1117 | 6543199 | 6156207 | 116 |
| LKV D 50 | 6041527 | 6178508 | 242 | | | | |
| LKV D 75 | 6041640 | 6178510 | 242 | SG2545 | 6628278 | 6028411 | 115 |
| LKV H | 6011285 | /100 pc. 6178349 | 248 | SK2545 | 6628216 | 6028403 | 115 |
| LKV H H | 6017829 | 6178650 | 248 | | | | |
| LKV N 100100 | 6015184 | price/m 6178441 | 241 | SL 20110 rws | 6723416 | 6132274 | 188 |
| LKV N 10037 | 6013913 | 6178435 | 240 | SL 20110 rws | 6719969 | 6132207 | 188 |
| LKV N 10050 | 6014033 | 6178437 | 240 | SL 2050 cws | 6719211 | 6132201 | 177 |
| LKV N 10075 | 6014156 | 6178439 | 241 | SL 2050 OT cws | 6730872 | 6132308 | 178 |
| LKV N 75025 | 6013197 | 6178420 | 239 | SL 2050 OT rws | 6730810 | 6132150 | 178 |
| LKV N 75037 | 6013319 | 6178422 | 239 | SL 2050 rws | 6726639 | 6132193 | 177 |
| LKV N 75050 | 6013432 | 6178424 | 239 | SL 2070 cws | 6719976 | 6132208 | 182 |
| LKV N 75075 | 6013555 | 6178426 | 239 | SL 2070 lgr | 6720842 | 6132269 | 182 |
| LKV N 75100 | 6013678 | 6178428 | 240 | SL 2070 rws | 6727599 | 6132267 | 182 |
| LKV N 75125 | 6013791 | 6178430 | 240 | SL AE20110 rws | 6720866 | 6132275 | 188 |
| LKVH 50037 | 5803744 | 6178582 | 244 | SL AE2050 cws | 6726684 | 6132266 | 177 |
| LKVH 50050 | 5803829 | 6178585 | 244 | SL AE2050 rws | 6726677 | 6132265 | 177 |
| LKVH 50075 | 5803836 | 6178588 | 244 | SL AE2070 cws | 6727629 | 6132271 | 182 |
| LKVH D 100 | 5981480 | 6178682 | 246 | SL AE2070 lgr | 6720859 | 6132272 | 182 |
| LKVH D 125 | 5981497 | 6178686 | 246 | SL AE2070 rws | 6727612 | 6132270 | 182 |
| LKVH D 37 | 5981459 | 6178670 | 246 | SL BL ANT cws | 6726646 | 6132195 | 187 |
| LKVH D 50 | 5981466 | 6178674 | 246 | SL BL ANT cws | 6726646 | 6132195 | 190 |
| LKVH D 75 | 5981473 | 6178678 | 246 | SL BL ANT rws | 6720781 | 6132258 | 187 |
| LKVH N 75037 | 5803751 | 6178552 | 244 | SL BL ANT rws | 6720781 | 6132258 | 190 |
| LKVH N 75050 | 5803768 | 6178556 | 245 | SL BL blind cws | 6720750 | 6132252 | 187 |
| LKVH N 75075 | 5803799 | 6178559 | 245 | SL BL blind cws | 6720750 | 6132252 | 190 |
| LKVH N 75100 | 5803805 | 6178563 | 245 | SL BL blind rws | 6726431 | 6132199 | 187 |
| LKVH N 75125 | 5803812 | 6178566 | 245 | SL BL blind rws | 6726431 | 6132199 | 190 |
| MA45WDK | 5787235 | /100 pc. 6024070 | 115 | SL ESli20110 rws | 6725380 | 6132300 | 188 |
| MKS 1845 rws | 6822287 | 6131377 | 56 | SL ESli2050 cws | 6724390 | 6132294 | 177 |
| MKS MFS 1845 KB | 6822294 | 6131380 | 56 | SL ESli2050 rws | 6724383 | 6132293 | 177 |
| OTK H110 | 5817901 | /100 pc. 6176128 | 113 | SL ESli2070 cws | 6725366 | 6132297 | 182 |
| OTK H110 | 5817901 | 6176128 | 138 | SL ESli2070 lgr | 6725373 | 6132298 | 182 |
| OTK H150 | 5817918 | 6176131 | 113 | SL ESli2070 rws | 6720071 | 6132296 | 182 |
| OTK H150 | 5817918 | 6176131 | 139 | SL ESre20110 rws | 6724345 | 6132286 | 189 |
| OTK H60 | 5817864 | 6176122 | 112 | SL ESre2050 cws | 6723423 | 6132278 | 177 |
| OTK H60 | 5817864 | 6176122 | 138 | SL ESre2050 rws | 6719914 | 6132277 | 177 |
| OTK H90 | 5817895 | 6176125 | 112 | SL ESre2070 cw | 6723454 | 6132282 | 182 |
| OTK H90 | 5817895 | 6176125 | 138 | SL ESre2070 lgr | 6723461 | 6132283 | 182 |
| RD 2GT40105 cws | 6724338 | 6132172 | 198 | SL ESre2070 rws | 6723447 | 6132281 | 182 |
| RD 2GT40105 rws | 6724321 | 6132171 | 198 | SL ETler20110rws | 6720682 | 6132242 | 189 |
| RD 2GTK40105 rws | 6733446 | 6132304 | 199 | SL ETler5070 cws | 6720668 | 6132239 | 185 |
| RD 40105 natur | 6719235 | 6132205 | 196 | SL ETler5070 lgr | 6720057 | 6132237 | 185 |
| RD AE40105 cws | 6723508 | 6132166 | 196 | SL ETler5070 rws | 6720651 | 6132238 | 185 |
| RD AE40105 rws | 6723409 | 6132165 | 196 | SL GTler20110rws | 6719891 | 6132236 | 189 |
| | | | | SL GTO 50-70 cws | 6719839 | 6132224 | 186 |
| | | | | SL GTO 50-70 lgr | 6719822 | 6132223 | 186 |
| | | | | SL GTO 50-70 rws | 6719846 | 6132229 | 186 |
| | | | | SL GTSa5070 cws | 6726424 | 6132197 | 187 |
| | | | | SL GTSa5070 rws | 6726448 | 6132234 | 187 |
| | | | | SL IE20110 rws | 6726653 | 6132259 | 188 |



| Type | GTIN | Item no. | Page | Type | GTIN | Item no. | Page |
|------------------|---------|----------|------|----------------|---------|----------|------|
| SL IE2050 cws | 6726455 | 6132249 | 177 | WDK A100230RW | 7250867 | 6024630 | 102 |
| SL IE2050 rws | 6720743 | 6132248 | 177 | WDK A80170CW | 7250522 | 6024654 | 98 |
| SL IE2070 cws | 6726486 | 6132254 | 182 | WDK A80170GR | 7250508 | 6024689 | 98 |
| SL IE2070 lgr | 6726493 | 6132255 | 182 | WDK A80170LGR | 7250546 | 6160485 | 98 |
| SL IE2070 rws | 6720767 | 6132253 | 182 | WDK A80170RW | 7250560 | 6160493 | 98 |
| SL KUP20110 rws | 6719884 | 6132235 | 189 | WDK A80210CW | 7250621 | 6160550 | 98 |
| SL KUP2050 cws | 6720620 | 6132226 | 178 | WDK A80210GR | 7250607 | 6161104 | 98 |
| SL KUP2050 rws | 6720613 | 6132225 | 178 | WDK A80210LGR | 7250645 | 6161112 | 98 |
| SL KUP2070 cws | 6719853 | 6132231 | 183 | WDK A80210RW | 7250669 | 6161155 | 98 |
| SL KUP2070 lgr | 6719860 | 6132232 | 183 | WDK F100130CW | 7251123 | 6161708 | 103 |
| SL KUP2070 rws | 6720644 | 6132230 | 183 | WDK F100130GR | 7251109 | 6161716 | 103 |
| SL2GT20110 rws | 6726462 | 6132250 | 189 | WDK F100130LGR | 7251147 | 6161759 | 103 |
| SL2GT5070 cws | 6720729 | 6132246 | 185 | WDK F100130RW | 7251161 | 6161775 | 103 |
| SL2GT5070 lgr | 6720736 | 6132247 | 185 | WDK F100230CW | 7251222 | 6182314 | 103 |
| SL2GT5070 rws | 6720712 | 6132245 | 185 | WDK F100230GR | 7251208 | 6182349 | 103 |
| SL2GTK5070 cws | 6732869 | 6132178 | 186 | WDK F100230LGR | 7251246 | 6182365 | 103 |
| SL2GTK5070 rws | 6732876 | 6132179 | 186 | WDK F100230RW | 7251260 | 6182713 | 103 |
| SLL 2050 cws | 6748327 | 6132157 | 178 | WDK F80170CW | 7250928 | 6182748 | 99 |
| SLL 2050 rws | 6719990 | 6132211 | 179 | WDK F80170GR | 7250904 | 6182764 | 99 |
| SLL 2070 cws | 6720002 | 6132212 | 179 | WDK F80170LGR | 7250942 | 6183523 | 99 |
| SLL 2070 rws | 6748334 | 6132158 | 178 | WDK F80170RW | 7250966 | 6183531 | 99 |
| SLL 2070 cws | 6720019 | 6132214 | 184 | WDK F80210CW | 7251024 | 6183574 | 99 |
| SLL 2070 rws | 6748358 | 6132159 | 178 | WDK F80210GR | 7251000 | 6192107 | 100 |
| SLL 2070 rws | 6720026 | 6132215 | 184 | WDK F80210LGR | 7251048 | 6192111 | 100 |
| SLL AE2050 cws | 6726660 | 6132261 | 179 | WDK F80210RW | 7251062 | 6192115 | 100 |
| SLL AE2050 rws | 6720798 | 6132260 | 179 | WDK GT1M45RW | 6617296 | 6154893 | 106 |
| SLL AE2070 cws | 6720811 | 6132263 | 184 | | | /pc. | |
| SLL AE2070 rws | 6720804 | 6132262 | 184 | WDK HA10020CW | 6099979 | 6153291 | 64 |
| SLL IE2050 cws | 6720675 | 6132241 | 179 | WDK HA10020RW | 6492015 | 6154417 | 63 |
| SLL IE2050 rws | 6720064 | 6132240 | 179 | WDK HA10030CW | 6804498 | 6153305 | 40 |
| SLL IE2070 cws | 6720705 | 6132244 | 184 | WDK HA10030RW | 6491537 | 6154425 | 40 |
| SLL IE2070 rws | 6720699 | 6132243 | 184 | WDK HA12022RW | 6615797 | 6154432 | 43 |
| SLT 2050 cws | 6720033 | 6132217 | 180 | | | /pc. | |
| SLT 2050 rws | 6720040 | 6132218 | 180 | WDK HA13025PW | 5959090 | 6192139 | 47 |
| SLT 2070 cws | 6720590 | 6132221 | 185 | WDK HA13025RW | 5959083 | 6192141 | 46 |
| SLT 2070 rws | 6720606 | 6132222 | 185 | WDK HA15030CW | 6579198 | 6160611 | 51 |
| SLT ESli2050 cws | 6724369 | 6132289 | 180 | WDK HA15030GR | 6579136 | 6158358 | 51 |
| SLT ESli2050 rws | 6724352 | 6132288 | 180 | WDK HA15030RW | 6795253 | 6192149 | 51 |
| SLT ESli2070 cws | 6793983 | 6132320 | 185 | WDK HA15040CW | 6579372 | 6160638 | 53 |
| SLT ESli2070 rws | 6724376 | 6132291 | 185 | WDK HA15040GR | 6579310 | 6158366 | 53 |
| SLT ESre2050 cws | 6725403 | 6132303 | 180 | WDK HA15040RW | 6494712 | 6192157 | 53 |
| SLT ESre2050 rws | 6725397 | 6132302 | 180 | WDK HA20020CW | 6579013 | 6160603 | 58 |
| SLT ESre2070 cws | 6726516 | 6132306 | 185 | WDK HA20020GR | 6578955 | 6158331 | 58 |
| SLT ESre2070 rws | 6726509 | 6132305 | 185 | WDK HA20020LGR | 6675197 | 6182402 | 58 |
| TRI 3535 OT rws | 6738526 | 6131190 | 118 | WDK HA20020RW | 6795314 | 6192165 | 58 |
| TRI 5050 OT rws | 6738533 | 6131191 | 119 | WDK HA20050CW | 6507856 | 6153372 | 61 |
| TRI C 35-16 rws | 6723300 | 6131182 | 118 | WDK HA20050GR | 6493210 | 6154468 | 61 |
| TRI C 35-50 rws | 6723317 | 6131185 | 119 | WDK HA25025CW | 6579556 | 6160646 | 66 |
| TRI ES350350 rws | 6723294 | 6131179 | 118 | WDK HA25025GR | 6579495 | 6158374 | 66 |
| TRI IE350350 rws | 6738519 | 6131171 | 118 | WDK HA25025LGR | 6675258 | 6182445 | 66 |
| TRI IE5050 rws | 6723270 | 6131172 | 119 | WDK HA25025RW | 6504855 | 6192173 | 66 |
| | | /100 pc. | | WDK HA25040CW | 6579730 | 6160654 | 69 |
| ULS | 6015061 | 6178548 | 252 | WDK HA25040GR | 6579679 | 6158382 | 69 |
| VF 10 rws | 6727698 | 6132600 | 254 | WDK HA25040RW | 6795376 | 6192181 | 69 |
| VF 10KB rws | 6727704 | 6132601 | 254 | WDK HA30030CW | 6580095 | 6160670 | 70 |
| VF 20 rws | 6727711 | 6132603 | 254 | WDK HA30030GR | 6580033 | 6158404 | 70 |
| VF 20KB rws | 6727728 | 6132604 | 254 | WDK HA30030LGR | 6675319 | 6182488 | 70 |
| VF 30 rws | 6727735 | 6132606 | 254 | WDK HA30030RW | 6795437 | 6192211 | 70 |
| VF 30KB rws | 6727742 | 6132607 | 254 | WDK HA30045CW | 6641598 | 6160689 | 72 |
| VF 40 rws | 6727759 | 6132609 | 254 | WDK HA30045GR | 6641536 | 6158420 | 72 |
| VF 40KB rws | 6727766 | 6132610 | 254 | WDK HA30045LGR | 6675371 | 6182496 | 72 |
| | | /pc. | | WDK HA30045RW | 6497171 | 6192238 | 72 |
| VK ISCS 5012 | 6149100 | 6178643 | 250 | WDK HA40040CW | 6580279 | 6160697 | 74 |
| VKHK | 6734139 | 6132594 | 232 | WDK HA40040GR | 6580217 | 6158412 | 74 |
| WDK A100130CW | 7250720 | 6024468 | 102 | WDK HA40040LGR | 6675432 | 6182526 | 74 |
| WDK A100130GR | 7250706 | 6024476 | 102 | WDK HA40040RW | 6795499 | 6192246 | 74 |
| WDK A100130LGR | 7250744 | 6024484 | 102 | WDK HA40060CW | 6106813 | 6160700 | 76 |
| WDK A100130RW | 7250768 | 6024506 | 102 | WDK HA40060GR | 6019212 | 6021697 | 76 |
| WDK A100230CW | 7250829 | 6024573 | 102 | WDK HA40060LGR | 6675494 | 6182534 | 76 |
| WDK A100230GR | 7250805 | 6024581 | 102 | WDK HA40060RW | 6795550 | 6192254 | 76 |
| WDK A100230LGR | 7250843 | 6024611 | 102 | WDK HA40090CW | 6106875 | 6160719 | 78 |
| | | | | WDK HA40090GR | 6017171 | 6021093 | 78 |
| | | | | WDK HA40090LGR | 6675555 | 6182542 | 78 |
| | | | | WDK HA40090RW | 6795611 | 6192262 | 78 |
| | | | | WDK HA40110CW | 6106936 | 6160727 | 80 |
| | | | | WDK HA40110GR | 6019274 | 6021700 | 80 |
| | | | | WDK HA40110LGR | 6675616 | 6182550 | 80 |
| | | | | WDK HA40110RW | 6220878 | 6192270 | 80 |
| | | | | WDK HA60060CW | 6107179 | 6160905 | 82 |
| | | | | WDK HA60060GR | 6020539 | 6022073 | 82 |
| | | | | WDK HA60060LGR | 6676392 | 6182593 | 82 |
| | | | | WDK HA60060RW | 6360970 | 6192319 | 82 |
| | | | | WDK HA60090CW | 6107230 | 6160913 | 84 |
| | | | | WDK HA60090GR | 6020713 | 6022111 | 84 |

Type listing

| Type | GTIN | Item no. | Page | Type | GTIN | Item no. | Page |
|-----------------|---------|----------|------|----------------|---------|----------|------|
| WDK HA60090LGR | 6676453 | 6182607 | 84 | WDK HE40060LGR | 6674350 | 6183735 | 77 |
| WDK HA60090RW | 6801558 | 6192327 | 84 | WDK HE40060RW | 6797479 | 6193226 | 77 |
| WDK HA60110CW | 6107292 | 6160921 | 86 | WDK HE40090CW | 6109579 | 6162614 | 79 |
| WDK HA60110GR | 6020836 | 6022146 | 86 | WDK HE40090GR | 6018918 | 6021506 | 79 |
| WDK HA60110LGR | 6676514 | 6182615 | 86 | WDK HE40090LGR | 6674411 | 6183743 | 79 |
| WDK HA60110RW | 6354559 | 6192335 | 86 | WDK HE40090RW | 6797530 | 6193234 | 79 |
| WDK HA60130CW | 6107353 | 6160948 | 88 | WDK HE40110CW | 6109630 | 6162622 | 81 |
| WDK HA60130GR | 6020959 | 6022162 | 88 | WDK HE40110GR | 6018970 | 6021514 | 81 |
| WDK HA60130LGR | 6676576 | 6182623 | 88 | WDK HE40110LGR | 6674473 | 6183751 | 81 |
| WDK HA60130RW | 6353057 | 6192343 | 88 | WDK HE40110RW | 6974788 | 6193242 | 81 |
| WDK HA60150CW | 6638352 | 6160972 | 90 | WDK HE60060CW | 6109876 | 6162800 | 83 |
| WDK HA60150GR | 6638291 | 6024521 | 90 | WDK HE60060GR | 6022694 | 6022499 | 83 |
| WDK HA60150LGR | 6676637 | 6182631 | 90 | WDK HE60060LGR | 6678372 | 6183808 | 83 |
| WDK HA60150RW | 6492312 | 6192351 | 90 | WDK HE60060RW | 6712991 | 6193285 | 83 |
| WDK HA60170CW | 6107414 | 6160956 | 92 | WDK HE60090CW | 6109937 | 6162819 | 85 |
| WDK HA60170GR | 6021079 | 6022189 | 92 | WDK HE60090GR | 6022755 | 6022502 | 85 |
| WDK HA60170LGR | 6676699 | 6182658 | 92 | WDK HE60090LGR | 6678433 | 6183816 | 85 |
| WDK HA60170RW | 6351855 | 6192378 | 92 | WDK HE60090RW | 6492794 | 6193293 | 85 |
| WDK HA60210CW | 6107476 | 6160964 | 94 | WDK HE60110CW | 6109999 | 6162827 | 87 |
| WDK HA60210GR | 6021130 | 6022197 | 94 | WDK HE60110GR | 6022991 | 6022588 | 87 |
| WDK HA60210LGR | 6676750 | 6182666 | 94 | WDK HE60110LGR | 6678495 | 6183824 | 87 |
| WDK HA60210RW | 6795673 | 6192386 | 94 | WDK HE60110RW | 6713059 | 6193307 | 87 |
| WDK HA60230CW | 6639731 | 6160980 | 96 | WDK HE60130CW | 6110056 | 6162835 | 89 |
| WDK HA60230GR | 6639670 | 6024548 | 96 | WDK HE60130GR | 6022816 | 6022529 | 89 |
| WDK HA60230LGR | 6676811 | 6182674 | 96 | WDK HE60130LGR | 6678556 | 6183832 | 89 |
| WDK HA60230RW | 6492374 | 6192394 | 96 | WDK HE60130RW | 6713110 | 6193315 | 89 |
| WDK HE100130CW | 6110353 | 6163041 | 102 | WDK HE60150CW | 6637997 | 6162878 | 91 |
| WDK HE100130GR | 6028337 | 6024882 | 102 | WDK HE60150GR | 6637935 | 6024823 | 91 |
| WDK HE100130LGR | 6678976 | 6183956 | 102 | WDK HE60150LGR | 6678617 | 6183840 | 91 |
| WDK HE100130RW | 5042655 | 6193395 | 102 | WDK HE60150RW | 6492855 | 6193323 | 91 |
| WDK HE10020CW | 6100392 | 6153593 | 63 | WDK HE60170CW | 6110117 | 6162843 | 93 |
| WDK HE10020GR | 6491834 | 6154514 | 63 | WDK HE60170GR | 6022878 | 6022545 | 93 |
| WDK HE10020LGR | 6651436 | 6163076 | 104 | WDK HE60170LGR | 6678679 | 6183859 | 93 |
| WDK HE10020RW | 6651375 | 6024904 | 104 | WDK HE60170RW | 6713172 | 6193331 | 93 |
| WDK HE100230LGR | 6679034 | 6183980 | 104 | WDK HE60210CW | 6110179 | 6162851 | 95 |
| WDK HE100230RW | 5042723 | 6193399 | 104 | WDK HE60210GR | 6022939 | 6022561 | 95 |
| WDK HE10030CW | 6100453 | 6153607 | 41 | WDK HE60210LGR | 6678730 | 6183867 | 95 |
| WDK HE10030RW | 6491353 | 6154522 | 41 | WDK HE60210RW | 6797592 | 6193358 | 95 |
| WDK HE12022RW | 6615827 | 6154532 | 44 | WDK HE60230CW | 6639373 | 6162886 | 97 |
| | | /pc. | | WDK HE60230GR | 6639311 | 6024831 | 97 |
| WDK HE13025PW | 6056033 | 6193088 | 48 | WDK HE60230LGR | 6678792 | 6183875 | 97 |
| WDK HE13025RW | 6056026 | 6193093 | 48 | WDK HE60230RW | 6492916 | 6193366 | 97 |
| WDK HE15015CW | 6642670 | 6162495 | 50 | WDK HE80170CW | 6110230 | 6163009 | 98 |
| WDK HE15015GR | 6642618 | 6158692 | 50 | WDK HE80170GR | 6028214 | 6024858 | 98 |
| WDK HE15015LGR | 6673933 | 6183603 | 50 | WDK HE80170LGR | 6678853 | 6183913 | 98 |
| WDK HE15015RW | 6797172 | 6193099 | 50 | WDK HE80170RW | 5042518 | 6193387 | 98 |
| WDK HE15030CW | 6583577 | 6162517 | 52 | WDK HE80210CW | 6110292 | 6163017 | 100 |
| WDK HE15030GR | 6434534 | 6158714 | 52 | WDK HE80210GR | 6028276 | 6024874 | 100 |
| WDK HE15030RW | 6797233 | 6193102 | 52 | WDK HE80210LGR | 6678914 | 6183921 | 100 |
| WDK HE15040CW | 6583690 | 6162525 | 54 | WDK HE80210RW | 5042587 | 6193391 | 100 |
| WDK HE15040GR | 6434596 | 6158722 | 54 | WDK HF10020CW | 6099139 | 6152600 | 64 |
| WDK HE15040RW | 6975624 | 6193110 | 54 | WDK HF10020RW | 6491896 | 6154212 | 63 |
| WDK HE20020CW | 6583454 | 6162509 | 59 | WDK HF10030CW | 6099191 | 6152619 | 40 |
| WDK HE20020GR | 6434473 | 6158706 | 59 | WDK HF10030RW | 6491414 | 6154220 | 40 |
| WDK HE20020LGR | 6673995 | 6183611 | 59 | WDK HF12022RW | 6615810 | 6154232 | 44 |
| WDK HE20020RW | 6797295 | 6193129 | 59 | | | /pc. | |
| WDK HE20035CW | 6643219 | 6162487 | 60 | WDK HF13025PW | 5959151 | 6192740 | 47 |
| WDK HE20035GR | 6643158 | 6158781 | 60 | WDK HF13025RW | 5959144 | 6192742 | 47 |
| WDK HE20035LGR | 6674053 | 6183654 | 60 | WDK HF15030CW | 6582075 | 6161219 | 52 |
| WDK HE20035RW | 6976768 | 6193137 | 60 | WDK HF15030GR | 6582013 | 6158595 | 52 |
| WDK HE20050CW | 6507672 | 6153674 | 62 | WDK HF15030RW | 6796694 | 6192750 | 52 |
| WDK HE20050RW | 6493395 | 6154557 | 62 | WDK HF15040CW | 6582259 | 6161227 | 54 |
| WDK HE25025CW | 6583812 | 6162533 | 67 | WDK HF15040GR | 6582198 | 6158609 | 54 |
| WDK HE25025GR | 6434657 | 6158730 | 67 | WDK HF15040RW | 6494835 | 6192769 | 54 |
| WDK HE25025LGR | 6674114 | 6183662 | 67 | WDK HF20020CW | 6581894 | 6161200 | 59 |
| WDK HE25025RW | 6504794 | 6193145 | 67 | WDK HF20020GR | 6581832 | 6158587 | 59 |
| WDK HE25040CW | 6583935 | 6162541 | 69 | WDK HF20020LGR | 6673391 | 6183212 | 59 |
| WDK HE25040GR | 6434718 | 6158749 | 69 | WDK HF20020RW | 6796755 | 6192777 | 59 |
| WDK HE25040RW | 6797356 | 6193153 | 69 | WDK HF20050CW | 6507733 | 6152686 | 62 |
| WDK HE30030CW | 6584239 | 6162576 | 71 | WDK HF20050RW | 6493333 | 6154255 | 62 |
| WDK HE30030GR | 6584178 | 6158765 | 71 | WDK HF25025CW | 6582433 | 6161235 | 66 |
| WDK HE30030LGR | 6674176 | 6183697 | 71 | WDK HF25025GR | 6582372 | 6158617 | 66 |
| WDK HE30030RW | 6797417 | 6193188 | 71 | WDK HF25025LGR | 6673452 | 6183255 | 66 |
| WDK HE30045CW | 6641239 | 6162584 | 73 | WDK HF25025RW | 6504916 | 6192785 | 66 |
| WDK HE30045GR | 6434831 | 6158803 | 73 | WDK HF25040CW | 6582617 | 6161243 | 69 |
| WDK HE30045LGR | 6674237 | 6183700 | 73 | WDK HF25040GR | 6582556 | 6158625 | 69 |
| WDK HE30045RW | 6497355 | 6193196 | 73 | WDK HF25040RW | 6796816 | 6192793 | 69 |
| WDK HE40040CW | 6583331 | 6162592 | 75 | WDK HF30030CW | 6582976 | 6161278 | 70 |
| WDK HE40040GR | 6583270 | 6158773 | 75 | WDK HF30030GR | 6582914 | 6158641 | 70 |
| WDK HE40040LGR | 6674299 | 6183727 | 75 | WDK HF30030LGR | 6673513 | 6183298 | 70 |
| WDK HE40040RW | 6712939 | 6193218 | 75 | WDK HF30030RW | 6796878 | 6192815 | 70 |
| WDK HE40060CW | 6109517 | 6162606 | 77 | WDK HF30045CW | 6641772 | 6161286 | 72 |
| WDK HE40060GR | 6018857 | 6021492 | 77 | WDK HF30045GR | 6641710 | 6158676 | 72 |

Type listing

| Type | GTIN | Item no. | Page | Type | GTIN | Item no. | Page |
|----------------|---------|----------|------|----------------|---------|----------|------|
| WDK HF30045LGR | 6673575 | 6183301 | 72 | WDK HI30045LGR | 6674831 | 6182100 | 72 |
| WDK HF30045RW | 6497294 | 6192823 | 72 | WDK HI30045RW | 6976829 | 6191932 | 72 |
| WDK HF40040CW | 6583157 | 6161294 | 74 | WDK HI40040CW | 6584598 | 6160093 | 74 |
| WDK HF40040GR | 6583096 | 6158668 | 74 | WDK HI40040GR | 6578832 | 6158293 | 74 |
| WDK HF40040LGR | 6673636 | 6183336 | 74 | WDK HI40040LGR | 6674893 | 6182119 | 74 |
| WDK HF40040RW | 6796939 | 6192831 | 74 | WDK HI40040RW | 6794898 | 6191940 | 74 |
| WDK HF40060CW | 6107711 | 6161308 | 76 | WDK HI40060CW | 6105915 | 6160107 | 76 |
| WDK HF40060GR | 6019458 | 6021735 | 76 | WDK HI40060GR | 6019335 | 6021719 | 76 |
| WDK HF40060LGR | 6673698 | 6183344 | 76 | WDK HI40060LGR | 6674954 | 6182127 | 76 |
| WDK HF40060RW | 6796991 | 6192858 | 76 | WDK HI40060RW | 6794959 | 6191959 | 76 |
| WDK HF40090CW | 6107773 | 6161316 | 79 | WDK HI40090CW | 6105977 | 6160115 | 78 |
| WDK HF40090GR | 6018253 | 6021336 | 79 | WDK HI40090GR | 6017652 | 6021190 | 78 |
| WDK HF40090LGR | 6673759 | 6183352 | 79 | WDK HI40090LGR | 6675012 | 6182135 | 78 |
| WDK HF40090RW | 6797059 | 6192866 | 79 | WDK HI40090RW | 6795017 | 6191967 | 78 |
| WDK HF40110CW | 6107834 | 6161324 | 81 | WDK HI40110CW | 6106035 | 6160123 | 80 |
| WDK HF40110GR | 6019519 | 6021743 | 81 | WDK HI40110GR | 6019397 | 6021727 | 80 |
| WDK HF40110LGR | 6673810 | 6183360 | 81 | WDK HI40110LGR | 6675074 | 6182143 | 80 |
| WDK HF40110RW | 6496990 | 6192874 | 81 | WDK HI40110RW | 6221110 | 6191975 | 80 |
| WDK HF60060CW | 6108077 | 6161502 | 82 | WDK HI60060CW | 6106271 | 6160301 | 82 |
| WDK HF60060GR | 6022519 | 6022448 | 82 | WDK HI60060GR | 6022212 | 6022383 | 82 |
| WDK HF60060LGR | 6677719 | 6183409 | 82 | WDK HI60060LGR | 6675739 | 6182194 | 82 |
| WDK HF60060RW | 6712694 | 6192912 | 82 | WDK HI60060RW | 6362950 | 6192017 | 82 |
| WDK HF60090CW | 6108138 | 6161510 | 85 | WDK HI60090CW | 6106332 | 6160328 | 84 |
| WDK HF60090GR | 6021796 | 6022316 | 85 | WDK HI60090GR | 6021253 | 6022219 | 84 |
| WDK HF60090LGR | 6677771 | 6183417 | 85 | WDK HI60090LGR | 6675791 | 6182208 | 84 |
| WDK HF60090RW | 6492619 | 6192920 | 85 | WDK HI60090RW | 6799879 | 6192025 | 84 |
| WDK HF60110CW | 6108190 | 6161529 | 87 | WDK HI60110CW | 6106394 | 6160336 | 86 |
| WDK HF60110GR | 6021918 | 6022332 | 87 | WDK HI60110GR | 6021376 | 6022235 | 86 |
| WDK HF60110LGR | 6677832 | 6183425 | 87 | WDK HI60110LGR | 6675852 | 6182216 | 86 |
| WDK HF60110RW | 6712755 | 6192939 | 87 | WDK HI60110RW | 6362776 | 6192033 | 86 |
| WDK HF60130CW | 6108251 | 6161537 | 88 | WDK HI60130CW | 6106455 | 6160344 | 88 |
| WDK HF60130GR | 6022038 | 6022359 | 88 | WDK HI60130GR | 6021499 | 6022251 | 88 |
| WDK HF60130LGR | 6677894 | 6183433 | 88 | WDK HI60130LGR | 6675913 | 6182224 | 88 |
| WDK HF60130RW | 6712816 | 6192947 | 88 | WDK HI60130RW | 6362479 | 6192041 | 88 |
| WDK HF60150CW | 6638536 | 6161561 | 90 | WDK HI60150CW | 6638178 | 6160379 | 90 |
| WDK HF60150GR | 6638475 | 6024599 | 90 | WDK HI60150GR | 6638116 | 6024432 | 90 |
| WDK HF60150LGR | 6677955 | 6183441 | 90 | WDK HI60150LGR | 6675975 | 6182232 | 90 |
| WDK HF60150RW | 6492671 | 6192955 | 90 | WDK HI60150RW | 6800056 | 6192068 | 90 |
| WDK HF60170CW | 6108312 | 6161545 | 92 | WDK HI60170CW | 6106516 | 6160352 | 92 |
| WDK HF60170GR | 6022151 | 6022375 | 92 | WDK HI60170GR | 6021611 | 6022286 | 92 |
| WDK HF60170LGR | 6678013 | 6183468 | 92 | WDK HI60170LGR | 6676033 | 6182240 | 92 |
| WDK HF60170RW | 6712878 | 6192963 | 92 | WDK HI60170RW | 6362233 | 6192076 | 92 |
| WDK HF60210CW | 6108374 | 6161553 | 94 | WDK HI60210CW | 6106578 | 6160360 | 94 |
| WDK HF60210GR | 6022274 | 6022391 | 94 | WDK HI60210GR | 6021673 | 6022294 | 94 |
| WDK HF60210LGR | 6678075 | 6183476 | 94 | WDK HI60210LGR | 6676095 | 6182259 | 94 |
| WDK HF60210RW | 6797110 | 6192971 | 94 | WDK HI60210RW | 6795079 | 6192084 | 94 |
| WDK HF60230CW | 6639915 | 6161596 | 97 | WDK HI60230CW | 6639557 | 6160395 | 96 |
| WDK HF60230GR | 6639854 | 6024602 | 97 | WDK HI60230GR | 6639496 | 6024440 | 96 |
| WDK HF60230LGR | 6678136 | 6183484 | 97 | WDK HI60230LGR | 6676156 | 6182267 | 96 |
| WDK HF60230RW | 6492732 | 6192998 | 97 | WDK HI60230RW | 6800896 | 6192092 | 96 |
| WDK HI10020CW | 6099559 | 6153003 | 64 | WDK HK40060CW | 6108619 | 6162002 | 77 |
| WDK HI10020RW | 6492077 | 6154328 | 63 | WDK HK40060GR | 6025459 | 6023312 | 77 |
| WDK HI10030CW | 6099610 | 6153011 | 40 | WDK HK40060LGR | 6673155 | 6182925 | 77 |
| WDK HI10030RW | 6491599 | 6154336 | 40 | WDK HK40060RW | 6796519 | 6192556 | 77 |
| WDK HI12022RW | 6615780 | 6154342 | 43 | WDK HK40090CW | 6108671 | 6162010 | 79 |
| | | /pc. | | WDK HK40090GR | 6024551 | 6023142 | 79 |
| WDK HI13025PW | 5959359 | 6191833 | 46 | WDK HK40090LGR | 6673216 | 6182933 | 79 |
| WDK HI13025RW | 5959342 | 6191835 | 46 | WDK HK40090RW | 6796571 | 6192564 | 79 |
| WDK HI15030CW | 6577811 | 6160026 | 51 | WDK HK40110CW | 6108732 | 6162029 | 81 |
| WDK HI15030GR | 6577750 | 6158234 | 51 | WDK HK40110GR | 6025572 | 6023339 | 81 |
| WDK HI15030RW | 6794652 | 6191843 | 51 | WDK HK40110LGR | 6673278 | 6182941 | 81 |
| WDK HI15040CW | 6577996 | 6160034 | 53 | WDK HK40110RW | 6500833 | 6192572 | 81 |
| WDK HI15040GR | 6577934 | 6158242 | 53 | WDK HK60060CW | 6108978 | 6162207 | 83 |
| WDK HI15040RW | 6494651 | 6191851 | 53 | WDK HK60060GR | 6025039 | 6023223 | 83 |
| WDK HI20020CW | 6577637 | 6160018 | 58 | WDK HK60060LGR | 6677054 | 6183018 | 83 |
| WDK HI20020GR | 6577576 | 6158226 | 58 | WDK HK60060RW | 6351794 | 6192610 | 83 |
| WDK HI20020LGR | 6674657 | 6182011 | 58 | WDK HK60090CW | 6109036 | 6162215 | 85 |
| WDK HI20020RW | 6794713 | 6191878 | 58 | WDK HK60090GR | 6023837 | 6023002 | 85 |
| WDK HI20050CW | 6507917 | 6153089 | 61 | WDK HK60090LGR | 6677115 | 6183026 | 85 |
| WDK HI20050RW | 6974542 | 6154360 | 61 | WDK HK60090RW | 6492435 | 6192629 | 85 |
| WDK HI25025CW | 6578177 | 6160042 | 66 | WDK HK60110CW | 6109098 | 6162223 | 87 |
| WDK HI25025GR | 6578115 | 6158250 | 66 | WDK HK60110GR | 6023950 | 6023029 | 87 |
| WDK HI25025LGR | 6674718 | 6182062 | 66 | WDK HK60110LGR | 6677177 | 6183034 | 87 |
| WDK HI25025RW | 6502219 | 6191886 | 66 | WDK HK60110RW | 6712519 | 6192637 | 87 |
| WDK HI25040CW | 6578351 | 6160050 | 68 | WDK HK60130CW | 6109159 | 6162231 | 89 |
| WDK HI25040GR | 6578290 | 6158269 | 68 | WDK HK60130GR | 6024070 | 6023045 | 89 |
| WDK HI25040RW | 6794775 | 6191894 | 68 | WDK HK60130LGR | 6677238 | 6183042 | 89 |
| WDK HI30030CW | 6578719 | 6160077 | 70 | WDK HK60130RW | 6712571 | 6192645 | 89 |
| WDK HI30030GR | 6578658 | 6158285 | 70 | WDK HK60150CW | 6638710 | 6162274 | 91 |
| WDK HI30030LGR | 6674770 | 6182097 | 70 | WDK HK60150GR | 6638659 | 6024769 | 91 |
| WDK HI30030RW | 6794836 | 6191924 | 70 | WDK HK60150LGR | 6677290 | 6183050 | 91 |
| WDK HI30045CW | 6641413 | 6160085 | 72 | WDK HK60150RW | 6492497 | 6192653 | 91 |
| WDK HI30045GR | 6641352 | 6158307 | 72 | WDK HK60170CW | 6109210 | 6162258 | 93 |



Type listing

| Type | GTIN | Item no. | Page | Type | GTIN | Item no. | Page |
|------------------|---------|----------|------|------------------|---------|----------|------|
| WDK HK60170GR | 6024193 | 6023061 | 93 | WDK HTCW13025PW | 5959137 | 6192448 | 47 |
| WDK HK60170LGR | 6677351 | 6183069 | 93 | WDK HTCW13025RW | 5959120 | 6192450 | 47 |
| WDK HK60170RW | 6712632 | 6192661 | 93 | WDK I100130CW | 7250300 | 6192417 | 103 |
| WDK HK60210CW | 6109272 | 6162266 | 95 | WDK I100130GR | 7250287 | 6192421 | 103 |
| WDK HK60210GR | 6024438 | 6023126 | 95 | WDK I100130LGR | 7250324 | 6192425 | 103 |
| WDK HK60210LGR | 6677412 | 6183077 | 95 | WDK I100130RW | 7250348 | 6192429 | 103 |
| WDK HK60210RW | 6796632 | 6192688 | 95 | WDK I100230CW | 7250423 | 6193026 | 104 |
| WDK HK60230CW | 6640096 | 6162290 | 96 | WDK I100230GR | 7250386 | 6193030 | 104 |
| WDK HK60230GR | 6640034 | 6024777 | 96 | WDK I100230LGR | 7250447 | 6193034 | 104 |
| WDK HK60230LGR | 6677474 | 6183085 | 96 | WDK I100230RW | 7250461 | 6193081 | 104 |
| WDK HK60230RW | 6492558 | 6192696 | 96 | WDK I80170CW | 7250102 | 6193078 | 99 |
| WDK HPC13025PW16 | 5959175 | 6193708 | 48 | WDK I80170GR | 7250072 | 6193080 | 99 |
| WDK HPC13025PW19 | 5959205 | 6193728 | 48 | WDK I80170LGR | 7250126 | 6193825 | 99 |
| WDK HPC13025PW20 | 5978060 | 6193731 | 48 | WDK I80170RW | 7250140 | 6193827 | 99 |
| WDK HPC13025RW16 | 5959168 | 6193710 | 48 | WDK I80210CW | 7250201 | 6193831 | 100 |
| WDK HPC13025RW19 | 5959182 | 6193730 | 48 | WDK I80210GR | 7250188 | 6193860 | 100 |
| WDK HPC13025RW20 | 5978053 | 6193729 | 48 | WDK I80210LGR | 7250225 | 6193864 | 100 |
| WDK HS10020CW | 6098293 | 6152007 | 64 | WDK I80210RW | 7250249 | 6193866 | 100 |
| WDK HS10020RW | 6492138 | 6154026 | 63 | WDK MH | 7249854 | 6028430 | 115 |
| WDK HS10030CW | 6098354 | 6152015 | 40 | WDK T100130CW | 7251543 | 6193400 | 103 |
| WDK HS10030RW | 6491650 | 6154034 | 40 | WDK T100130GR | 7251581 | 6193410 | 103 |
| WDK HS12022RW | 6615773 | 6154042 | 43 | WDK T100130LGR | 7251567 | 6163090 | 103 |
| | | /pc. | | WDK T100130RW | 7251505 | 6183990 | 102 |
| WDK HS13025PW | 5959076 | 6193496 | 46 | WDK T100230CW | 7251659 | 6193402 | 103 |
| WDK HS13025RW | 5959069 | 6193498 | 46 | WDK T100230GR | 7251697 | 6193412 | 103 |
| WDK HS15030CW | 6507610 | 6152031 | 51 | WDK T100230LGR | 7251673 | 6163092 | 103 |
| WDK HS15030GR | 6507559 | 6158838 | 51 | WDK T100230RW | 7251604 | 6183992 | 104 |
| WDK HS15030RW | 6223695 | 6193501 | 51 | WDK T80170CW | 7251345 | 6193404 | 99 |
| WDK HS15040CW | 6098477 | 6152058 | 53 | WDK T80170GR | 7251383 | 6193414 | 99 |
| WDK HS15040GR | 6507498 | 6158846 | 53 | WDK T80170LGR | 7251369 | 6163094 | 99 |
| WDK HS15040RW | 6975266 | 6193528 | 53 | WDK T80170RW | 7251307 | 6183994 | 98 |
| WDK HS20050CW | 6507252 | 6152104 | 61 | WDK T80210CW | 7251444 | 6193406 | 99 |
| WDK HS20050RW | 6974481 | 6154069 | 61 | WDK T80210GR | 7251482 | 6193415 | 99 |
| WDK HS25040CW | 6507375 | 6152082 | 68 | WDK T80210LGR | 7251468 | 6163096 | 99 |
| WDK HS25040GR | 6507436 | 6158889 | 68 | WDK T80210RW | 7251406 | 6183996 | 100 |
| WDK HS25040RW | 6507313 | 6193560 | 68 | | | price/m | |
| WDK HS40090CW | 5462170 | 6193582 | 78 | WDK100130CW | 6030132 | 6026273 | 102 |
| WDK HS40090RW | 5461814 | 6193580 | 78 | WDK100130GR | 6030194 | 6026281 | 102 |
| WDK HS40110CW | 5462187 | 6193588 | 80 | WDK100130LGR | 6668595 | 6027245 | 102 |
| WDK HS40110RW | 5461821 | 6193586 | 80 | WDK100130RW | 5042297 | 6191347 | 102 |
| WDK HS60090CW | 5462217 | 6193592 | 84 | WDK10020CW | 6098170 | 6150756 | 62 |
| WDK HS60090RW | 5461838 | 6193590 | 84 | WDK10020GR | 6492251 | 6150764 | 62 |
| WDK HS60110CW | 5462224 | 6193598 | 86 | WDK10020RW | 5396703 | 6027318 | 64 |
| WDK HS60110RW | 5461845 | 6193596 | 86 | WDK10020SRW | 7005207 | 6027374 | 64 |
| WDK HT10020CW | 6098712 | 6152309 | 65 | WDK10020SSW | 7005023 | 6027321 | 62 |
| WDK HT10020RW | 6491957 | 6154115 | 65 | | | price/m | |
| WDK HT10030CW | 6098774 | 6152317 | 41 | WDK100230CW | 6642137 | 6026338 | 104 |
| WDK HT10030RW | 6491476 | 6154123 | 41 | WDK100230GR | 6642076 | 6026311 | 104 |
| WDK HT12022RW | 6615803 | 6154132 | 44 | WDK100230LGR | 6668656 | 6027253 | 104 |
| | | /pc. | | WDK100230RW | 5042303 | 6191355 | 104 |
| WDK HT13025PW | 5959113 | 6192449 | 47 | WDK10030CW | 6508037 | 6150772 | 40 |
| WDK HT13025RW | 5959106 | 6192451 | 47 | WDK10030GR | 6491773 | 6150780 | 40 |
| WDK HT15030CW | 6580637 | 6161928 | 52 | WDK12022RW | 6615766 | 6150702 | 42 |
| WDK HT15030GR | 6580576 | 6158463 | 52 | WDK12022RW 2100 | 6623846 | 6150703 | 42 |
| WDK HT15030RW | 6796212 | 6192459 | 52 | WDK12022TRW | 6642878 | 6027300 | 43 |
| WDK HT15040CW | 6580811 | 6161936 | 54 | WDK12022TRW 2100 | 6642885 | 6027301 | 43 |
| WDK HT15040GR | 6580750 | 6158471 | 54 | | | price/m | |
| WDK HT15040RW | 6494774 | 6192467 | 54 | WDK13025 | 5438939 | 6187704 | 46 |
| WDK HT20020CW | 6580453 | 6161901 | 59 | WDK13025 | 5438946 | 6187714 | 46 |
| WDK HT20020GR | 6580392 | 6158455 | 59 | WDK15015BR | 6642373 | 6024971 | 50 |
| WDK HT20020LGR | 6672851 | 6182801 | 59 | WDK15015CW | 6642311 | 6024963 | 50 |
| WDK HT20020RW | 6796274 | 6192475 | 59 | WDK15015GR | 6642250 | 6024955 | 50 |
| WDK HT20050CW | 6507795 | 6152384 | 62 | WDK15015LGR | 6667338 | 6024947 | 50 |
| WDK HT20050GR | 6493272 | 6154166 | 62 | WDK15015RW | 6794058 | 6191002 | 50 |
| WDK HT20050RW | 6580996 | 6161944 | 67 | WDK15015SW | 7005054 | 6024949 | 50 |
| WDK HT25025GR | 6580934 | 6158498 | 67 | | | price/m | |
| WDK HT25025LGR | 6672912 | 6182852 | 67 | WDK15030BR | 6332892 | 6025021 | 51 |
| WDK HT25025RW | 6504978 | 6192483 | 67 | WDK15030CW | 6332830 | 6025013 | 51 |
| WDK HT25040CW | 6581177 | 6161952 | 69 | WDK15030GR | 6332779 | 6025005 | 51 |
| WDK HT25040GR | 6581115 | 6158501 | 69 | WDK15030LGR | 6794539 | 6025048 | 51 |
| WDK HT25040RW | 6796335 | 6192491 | 69 | WDK15030RW | 6794119 | 6191010 | 51 |
| WDK HT30030CW | 6581535 | 6161979 | 71 | | | /pc. | |
| WDK HT30030GR | 6581474 | 6158536 | 71 | WDK15030RW2500 | 6406623 | 6191013 | 51 |
| WDK HT30030LGR | 6672974 | 6182887 | 71 | | | price/m | |
| WDK HT30030RW | 6796397 | 6192513 | 71 | WDK15030SRW | 5164210 | 6027325 | 51 |
| WDK HT30045CW | 6641956 | 6161987 | 73 | WDK15040CW | 6028634 | 6025161 | 53 |
| WDK HT30045GR | 6641895 | 6158552 | 73 | WDK15040GR | 6028511 | 6025137 | 53 |
| WDK HT30045LGR | 6673032 | 6182895 | 73 | WDK15040RW | 6494590 | 6191029 | 53 |
| WDK HT30045RW | 6497232 | 6192521 | 73 | WDK15040SRW | 5164227 | 6027335 | 53 |
| WDK HT40040CW | 6581719 | 6161995 | 75 | | | | |
| WDK HT40040GR | 6581658 | 6158544 | 75 | WDK20020BR | 6028450 | 6025129 | 58 |
| WDK HT40040LGR | 6673094 | 6182917 | 75 | WDK20020CW | 6028573 | 6025153 | 58 |
| WDK HT40040RW | 6796458 | 6192548 | 75 | | | | |

Type listing

| Type | GTIN | Item no. | Page | Type | GTIN | Item no. | Page |
|-------------|---------|----------|------|------------------|---------|----------|------|
| | | price/m | | | | price/m | |
| WDK20020GR | 6028399 | 6025110 | 58 | WDK60210LGR | 6668359 | 6027172 | 94 |
| WDK20020LGR | 6667390 | 6025102 | 58 | WDK60210RW | 6794478 | 6191266 | 94 |
| WDK20020RW | 6794171 | 6191037 | 58 | WDK60230CW | 6638956 | 6021891 | 96 |
| WDK20020SRW | 5164265 | 6027360 | 58 | WDK60230GR | 6638895 | 6022057 | 96 |
| WDK20020SW | 7005085 | 6025155 | 58 | WDK60230LGR | 6668410 | 6027180 | 96 |
| | | price/m | | WDK60230RW | 6799459 | 6191274 | 96 |
| WDK20035CW | 6642854 | 6026370 | 60 | WDK80170CW | 6029778 | 6026176 | 98 |
| WDK20035GR | 6642793 | 6026362 | 60 | WDK80170GR | 6029839 | 6026184 | 98 |
| WDK20035LGR | 6667451 | 6026354 | 60 | WDK80170LGR | 6668472 | 6027229 | 98 |
| WDK20035RW | 6496938 | 6191045 | 60 | WDK80170RW | 5042273 | 6191304 | 98 |
| WDK20050CW | 6438433 | 6168701 | 61 | WDK80210CW | 6029952 | 6026206 | 100 |
| WDK20050RW | 6801671 | 6168736 | 61 | WDK80210GR | 6029891 | 6026192 | 100 |
| WDK25025CW | 6030316 | 6026427 | 66 | WDK80210LGR | 6668533 | 6027237 | 100 |
| WDK25025GR | 6030255 | 6026419 | 66 | WDK80210RW | 5042280 | 6191312 | 100 |
| WDK25025LGR | 6667512 | 6026400 | 66 | | | | |
| WDK25025RW | 6505036 | 6191053 | 66 | WDKH-10020RW | 5933779 | 6175375 | 122 |
| WDK25025SRW | 5773399 | 6027372 | 66 | WDKH-10020RW T | 5933984 | 6175377 | 122 |
| WDK25040CW | 6030491 | 6026451 | 68 | WDKH-15030LGR | 5933977 | 6175457 | 124 |
| WDK25040GR | 6030439 | 6026443 | 68 | WDKH-15030RW | 5933953 | 6175390 | 124 |
| WDK25040LGR | 6794591 | 6026486 | 68 | WDKH-15030RW T | 5933991 | 6175392 | 124 |
| WDK25040RW | 6794232 | 6191061 | 68 | WDKH-20020LGR | 5817789 | 6175460 | 126 |
| WDK25040SW | 7005115 | 6026488 | 68 | WDKH-20020RW | 5812456 | 6175400 | 126 |
| | | price/m | | WDKH-30045LGR | 5817796 | 6175463 | 128 |
| WDK30030BR | 6333073 | 6026834 | 70 | WDKH-30045RW | 5812463 | 6175405 | 128 |
| WDK30030CW | 6333011 | 6026826 | 70 | WDKH-40060LGR | 5817802 | 6175466 | 130 |
| WDK30030GR | 6332953 | 6026818 | 70 | WDKH-40060RW | 5812470 | 6175410 | 130 |
| WDK30030LGR | 6667574 | 6026796 | 70 | WDKH40060RW 2500 | 6974894 | 6175412 | 130 |
| WDK30030RW | 6794294 | 6191096 | 70 | WDKH-60090LGR | 5817833 | 6175469 | 132 |
| WDK30045CW | 6640935 | 6026869 | 72 | WDKH-60090RW | 5812487 | 6175415 | 132 |
| WDK30045GR | 6640874 | 6026850 | 72 | WDKH60090RW 2500 | 6975129 | 6175417 | 132 |
| WDK30045LGR | 6667635 | 6026842 | 72 | | | price/m | |
| WDK30045RW | 6497058 | 6191118 | 72 | WDKH-60110LGR | 5817840 | 6175472 | 134 |
| | | | | WDKH-60110RW | 5812494 | 6175420 | 134 |
| WDK40040BR | 6028931 | 6025420 | 74 | WDKH-60150LGR | 5817857 | 6175475 | 136 |
| WDK40040CW | 6028870 | 6025412 | 74 | WDKH-60150RW | 5812500 | 6175425 | 136 |
| WDK40040GR | 6028993 | 6025447 | 74 | | | /pc. | |
| WDK40040LGR | 6667697 | 6027016 | 74 | WDKH-A10020RW | 5933830 | 6175612 | 122 |
| WDK40040RW | 6363490 | 6191126 | 74 | WDKH-A15030RW | 5934127 | 6175618 | 124 |
| WDK40060BR | 6029051 | 6025617 | 76 | WDKH-A20020LGR | 5922865 | 6176000 | 126 |
| WDK40060CW | 6016273 | 6020887 | 76 | WDKH-A20020RW | 5922841 | 6175624 | 126 |
| WDK40060GR | 6029112 | 6025633 | 76 | WDKH-A30045LGR | 5814955 | 6176004 | 128 |
| WDK40060LGR | 6667758 | 6027024 | 76 | WDKH-A30045RW | 5814061 | 6175626 | 128 |
| WDK40060RW | 6794355 | 6191134 | 76 | WDKH-A40060LGR | 5814962 | 6176008 | 130 |
| WDK40060SW | 7005146 | 6025638 | 76 | WDKH-A40060RW | 5814078 | 6175630 | 130 |
| | | price/m | | WDKH-A60090LGR | 5814979 | 6176012 | 132 |
| WDK40090CW | 6016334 | 6020895 | 78 | WDKH-A60090RW | 5814085 | 6175634 | 132 |
| WDK40090GR | 6016877 | 6021018 | 78 | WDKH-A60110LGR | 5814986 | 6176016 | 134 |
| WDK40090LGR | 6667819 | 6027032 | 78 | WDKH-A60110RW | 5814092 | 6175638 | 134 |
| WDK40090RW | 6794416 | 6191142 | 78 | WDKH-A60150LGR | 5815020 | 6176020 | 136 |
| WDK40090SW | 7005177 | 6021023 | 78 | WDKH-A60150RW | 5814108 | 6175642 | 136 |
| | | price/m | | WDKH-E10020RW | 5814108 | 6175642 | 136 |
| WDK40110CW | 6016396 | 6020909 | 80 | WDKH-E10020RW | 5933946 | 6175540 | 123 |
| WDK40110GR | 6016990 | 6021034 | 80 | WDKH-E15030RW | 5934233 | 6175546 | 125 |
| WDK40110LGR | 6667871 | 6027040 | 80 | WDKH-E20020LGR | 5814597 | 6175928 | 127 |
| WDK40110RW | 6501199 | 6191150 | 80 | WDKH-E20020RW | 5813910 | 6175550 | 127 |
| | | | | WDKH-E30045LGR | 5814603 | 6175932 | 129 |
| WDK60060CW | 6020171 | 6021948 | 82 | WDKH-E30045RW | 5813927 | 6175554 | 129 |
| WDK60060GR | 6029174 | 6025668 | 82 | WDKH-E40060LGR | 5814610 | 6175936 | 131 |
| WDK60060LGR | 6667994 | 6027105 | 82 | WDKH-E40060RW | 5813934 | 6175558 | 131 |
| WDK60060RW | 6363018 | 6191193 | 82 | WDKH-E60090LGR | 5814627 | 6175940 | 133 |
| WDK60090CW | 6020119 | 6021913 | 84 | WDKH-E60090RW | 5813941 | 6175562 | 133 |
| WDK60090GR | 6020232 | 6022006 | 84 | WDKH-E60110LGR | 5814863 | 6175944 | 135 |
| WDK60090LGR | 6668052 | 6027113 | 84 | WDKH-E60110RW | 5813958 | 6175566 | 135 |
| WDK60090RW | 6491292 | 6191207 | 84 | WDKH-E60150LGR | 5814870 | 6175948 | 137 |
| WDK60110CW | 6019816 | 6021840 | 86 | WDKH-E60150RW | 5813965 | 6175570 | 137 |
| WDK60110GR | 6020294 | 6022014 | 86 | WDKH-F10020RW | 5933885 | 6175648 | 123 |
| WDK60110LGR | 6668113 | 6027121 | 86 | WDKH-F15030RW | 5934158 | 6175654 | 125 |
| WDK60110RW | 6363438 | 6191215 | 86 | WDKH-F20020LGR | 5922919 | 6176036 | 126 |
| WDK60130CW | 6019878 | 6021859 | 88 | WDKH-F20020RW | 5922896 | 6175658 | 126 |
| WDK60130GR | 6020355 | 6022022 | 88 | WDKH-F30045LGR | 5815037 | 6176040 | 128 |
| WDK60130LGR | 6668175 | 6027148 | 88 | WDKH-F30045RW | 5814115 | 6175662 | 128 |
| WDK60130RW | 6363377 | 6191223 | 88 | WDKH-F40060LGR | 5815044 | 6176044 | 130 |
| WDK60150CW | 6637577 | 6021883 | 90 | WDKH-F40060RW | 5814122 | 6175666 | 130 |
| WDK60150GR | 6637515 | 6022030 | 90 | WDKH-F60090LGR | 5815075 | 6176048 | 132 |
| WDK60150LGR | 6668236 | 6027156 | 90 | WDKH-F60090RW | 5814139 | 6175670 | 132 |
| WDK60150RW | 6491230 | 6191231 | 90 | WDKH-F60110LGR | 5815082 | 6176052 | 134 |
| WDK60170CW | 6019939 | 6021867 | 92 | WDKH-F60110RW | 5814146 | 6175674 | 134 |
| WDK60170GR | 6020416 | 6022049 | 92 | WDKH-F60150LGR | 5815099 | 6176056 | 136 |
| WDK60170LGR | 6668298 | 6027164 | 92 | WDKH-F60150RW | 5814153 | 6175678 | 136 |
| WDK60170RW | 6363193 | 6191258 | 92 | WDKH-I10020RW | 5933809 | 6175572 | 122 |
| WDK60210CW | 6019991 | 6021875 | 94 | WDKH-I15030RW | 5934073 | 6175578 | 124 |
| WDK60210GR | 6020478 | 6022065 | 94 | WDKH-I20020LGR | 5922803 | 6175964 | 126 |
| | | | | WDKH-I20020RW | 5922780 | 6175581 | 126 |



Type listing

| Type | GTIN | Item no. | Page |
|----------------|---------|--------------------|------|
| WDKH-I30045LGR | 5814887 | 6175968 /pc. | 128 |
| WDKH-I30045RW | 5814016 | 6175590 | 128 |
| WDKH-I40060LGR | 5814894 | 6175972 | 130 |
| WDKH-I40060RW | 5814023 | 6175594 | 130 |
| WDKH-I60090LGR | 5814900 | 6175976 | 132 |
| WDKH-I60090RW | 5814030 | 6175598 | 132 |
| WDKH-I60110LGR | 5814917 | 6175980 | 134 |
| WDKH-I60110RW | 5814047 | 6175602 | 134 |
| WDKH-I60150LGR | 5814924 | 6175984 | 136 |
| WDKH-I60150RW | 5814054 | 6175606 | 136 |
| WDKH-T10020RW | 5933915 | 6175684 | 123 |
| WDKH-T15030RW | 5934189 | 6175690 | 125 |
| WDKH-T20020LGR | 5922971 | 6176072 | 126 |
| WDKH-T20020RW | 5922926 | 6175694 | 126 |
| WDKH-T30045LGR | 5815105 | 6176076 | 128 |
| WDKH-T30045RW | 5814160 | 6175698 | 128 |
| WDKH-T40060LGR | 5815112 | 6176080 | 130 |
| WDKH-T40060RW | 5814177 | 6175702 | 130 |
| WDKH-T60090LGR | 5815129 | 6176084 | 132 |
| WDKH-T60090RW | 5814184 | 6175706 | 132 |
| WDKH-T60110LGR | 5815136 | 6176088 | 134 |
| WDKH-T60110RW | 5814191 | 6175710 | 134 |
| WDKH-T60150LGR | 5815143 | 6176092 | 136 |
| WDKH-T60150RW | 5814207 | 6175714 | 136 |
| WDKH-TW40LGR | 5812517 | 6175500 price/m | 138 |
| WDKH-TW60LGR | 5812524 | 6175504 | 138 |
| WDKMD12CW | 6097692 | 6150179 | 37 |
| WDKMD12RW | 6493036 | 6150284 | 36 |
| WDKMD12S | 5154501 | 6150330 | 37 |
| WDKMD12S | 5154501 | 6150330 | 37 |
| WDKMD17CW | 6097753 | 6150187 | 38 |
| WDKMD17RW | 6492978 | 6150292 | 36 |
| WDKMD17S | 5154549 | 6150334 | 38 |
| WDKMD4CW | 6097579 | 6150152 | 37 |
| WDKMD4RW | 6493159 | 6150268 | 36 |
| WDKMD7CW | 6097630 | 6150160 | 37 |
| WDKMD7RW | 6493098 | 6150276 | 36 |
| WDKMD7S | 5154495 | 6150326 | 37 |
| WDK-N20050CW | 6438495 | 6168728 | 61 |
| WDK-N20050RW | 6802159 | 6168744 | 61 |
| WDK-N25040CW | 6507191 | 6150632 | 68 |
| WDK-N25040RW | 6975686 | 6150640 | 68 |







© OBO Bettermann Order no. 9178357 03/2023 EN

**OBO Bettermann
Holding GmbH & Co. KG**
P.O. Box 1120
58694 Menden
GERMANY

Customer Service
Tel.: +49 23 73 89 - 17 00
export@obo.de

www.obo-bettermann.com

Building Connections

